

Easy to Build Kitchen Cabinets

For the Remodeled Farm Home

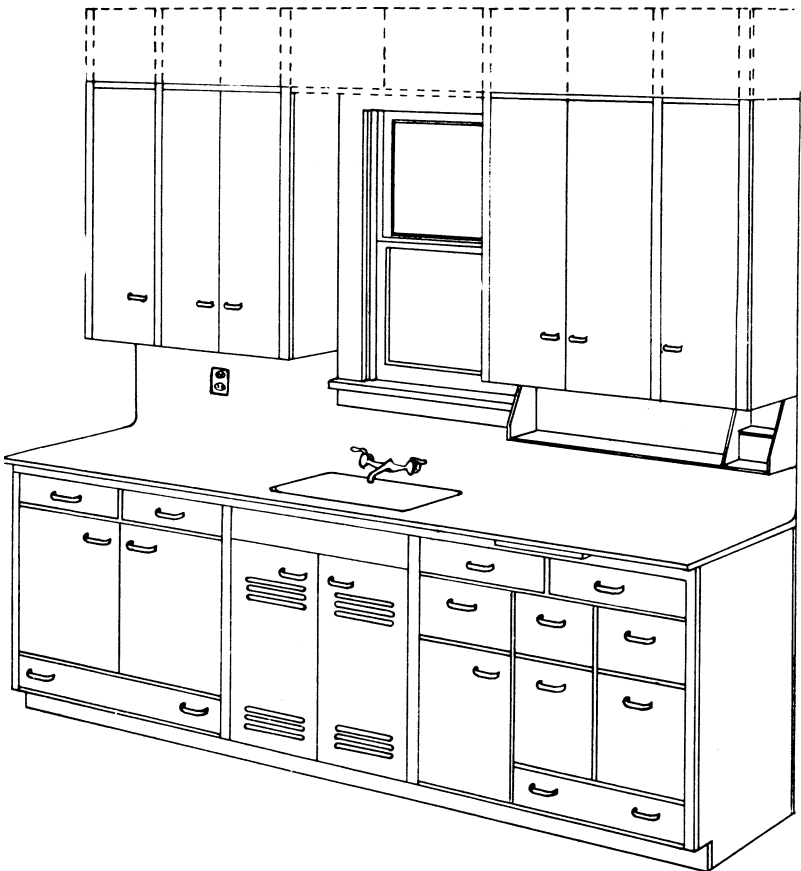

Circular 485

EXTENSION SERVICE
OKLAHOMA A. AND M. COLLEGE
SHAWNEE BROWN, Director
Stillwater

Easy to Build Kitchen Cabinets

Where to Order Cabinet Plans

Enlarged working drawings for any or all of the cabinet units shown in this circular may be ordered from the Extension Agricultural Engineer, Extension Service, Oklahoma A. and M. College, Stillwater, Oklahoma. There is a charge of 15 cents per sheet to cover cost of paper and printing.

Different Units Available

These easy-to-build kitchen cabinets include eight different units, each designed to serve a specific need:

Food preparation and clearing cabinets	Storage cabinet
Wood box	Utility and food storage cabinet
Serving cabinet	Utility cabinet
Wall cabinet	Chore clothes cabinet

The cabinets were planned especially for remodeling kitchens where continuous work areas cannot be used. Old farm kitchens often have many doors and windows, and in remodeling it is impossible, or too expensive, to move them. These cabinets can be built as individual units to fit between doors and windows, providing separated work areas, or, if space permits, they can be grouped together. In various combinations they will provide adequate storage and working surface for the average farm kitchen.

On plan 7034 all of the units are illustrated and three different arrangements of the cabinets are shown. Many other arrangements are possible, depending on the size of the kitchen and the location of doors and windows. Plans 7035 to 7042 give working drawings for building the eight units.

Easy-to-Use Plans

The working drawings for building the cabinets have been made as simple as possible so that even persons not familiar with

following working drawings will find them easy to use. They are similar to dress patterns. For each cabinet, each piece is shown in detail with all necessary dimensions, and is numbered. The numbered pieces are also shown put together in an assembly drawing or perspective so that the location of each individual part is easily seen.

On each set of drawings a bill of materials is given for both lumber and hardware.

Materials Needed

Materials and tools needed to build the cabinets are generally familiar to the farm carpenter. The cabinets as shown are built of plywood and pine "shelving." In some of the larger pieces such as ends of cabinets pine boards are shown tongued and grooved and glued together to form the necessary width. Plywood of equal thickness could be used instead. Plywood is specified for pieces too large to warrant gluing boards together or where it is needed for stiffening as, for example, in the backs of cabinets.

Wherever possible, standard dimension boards, such as 1" x 4", 1" x 6", 1" x 12", have been used full width to avoid ripping and planing. On the working drawings the actual rather than the nominal dimensions are given. A nominal 1" x 4" board, for example, measures about $3/4$ x $3-5/8$ ".

For counter tops, linoleum or pressed wood has been suggested.

Suggestions on Building

Seven feet 4 inches high, the cabinets will fit in most farm-houses. If a space of less than a foot is left between cabinet top and ceiling, it is best to close it in with a board or to nail furring strips between ceiling and top of cabinet and apply lath and plaster. A space of more than 12 inches may be used for additional cabinets for dead storage. Plans for such cabinets are not shown but they should be built in the same way as wall cabinets.

Counter height is 36 inches. It can be varied for the tall or short woman by increasing or decreasing the toe space under the cabinets up to 2 inches. If a great deal of baking is done and a lower counter is desired for mixing and kneading, the top of the wood box cabinet (7036) or the kitchen meal table can be used.

Shelves and dividers on shelves and in drawers are adjustable in all cabinets except the large storage cabinet (7039). Shelf heights shown on the drawings suggest good use of space. These heights provide for storage of the heaviest and the most often used supplies and dishes in the locations that are most easily reached.

Building the drawers is the most difficult part of making the cabinets. If the farm shop does not have a routing plane for cutting the grooves, this part of the work can usually be done at the local lumber yard.

Food Preparation and Clearing Cabinets

PLAN 7035

This unit of two base cabinets, two wall cabinets, and a sink cabinet is planned to provide adequate working surfaces for food preparation and dishwashing, storage space for supplies and equipment for those jobs, and storage for everyday dishes. Since it is the most used work center in the kitchen, the unit is designed so there can be a window above the sink to give natural light and a view of outdoor activities.

CABINETS A AND B. Base cabinet A, to the right of the sink, is designed to hold staple food supplies that are bought in large quantities, such as flour and sugar. It is also planned for storage of the mixing, baking, and cooking utensils most often used in food preparation.

In wall cabinet B, planned to be used above base A, can be kept other staple supplies, with foods like dried fruits that are used first with water in the section nearest the sink.

A narrow open shelf (42) under cabinet B provides convenient storage for spices and often-used foods that are kept in covered jars or canisters.

For greatest convenience the refrigerator should be at the right of cabinets A and B, so that all food supplies, perishables as well as staples, will be at hand.

The top of cabinet A makes a food preparation counter. A pull-out board with gravity released stop (17) furnishes a slightly lower surface for mixing, rolling, or kneading. It also provides a firm place for attaching the food grinder. The board slips back in place with a slight tap of the fingers on the gravity stop.

After meals the counter top of cabinet A serves as a clearing and stacking counter for dirty dishes.

CABINET C. A single-bowl sink forms the top of this cabinet. The sink is large enough for two dishpans or dishpan and drainer and for washing large utensils used in the home dairy and in canning.

In the cabinet is storage space for dishpans and drainer. Soap flakes and scouring powders may be stored in the rack on the left-hand door and often-used soap kept in a soap tray near the faucets. There is room on the floor in back of the dishpans for additional cleaning supplies, also for a bucket and for temporary storage of empty jars and cans. The garbage can is mounted on the inside of the right-hand door where it is easy to reach.

CABINETS D AND E. Base cabinet D at the left of the sink holds cooking utensils. The adjustable shelf (13) measures only 18 inches from front to back, making it easy to see articles stored in the bottom of the cabinet and to grasp the handles of pans. The counter top of this cabinet provides a place to stack dishes after they are dried. A bread box on the left end of the counter will provide convenient storage for baked goods.

Wall cabinet E, above base cabinet D, is designed for storage of everyday dishes. It will hold a service for eight and has space in addition for ready-to-serve packaged cereals and partly used jars of jellies and relishes. The right end of the cabinet is a good place for a swinging arm bar for tea towels.

Wood Box, Serving, and Wall Cabinets

PLANS 7036, 7037, 7038

These three cabinets are planned to provide the counter space and storage needed at the kitchen range.

Wood Box (7036)

This wood box is the height of the usual kitchen range so it makes a convenient serving counter and provides a place for setting hot pans as they are taken from the stove.

The top (15) is metal covered and is divided into two sections opening in the center. When open, the left-hand section folds down against the side of the box. A strip of wood (21) on the right-hand side of the cabinet, which is next to the stove, holds the

right lid in an almost upright position when open. This prevents dust and particles of dirt from flying onto the stove when wood is tossed into the box.

To meet safety requirements of the Underwriters' Laboratories, the side of the wood box next to the firebox of the range is covered with sheet metal to provide fireproofing. If ¼-inch asbestos board is used under the sheet metal the wood box can be placed 18 inches from the firebox side of the range. Otherwise it must be 24 inches away.

The metal-covered side of the box can be used to advantage for hanging utensils used at the range, such as skillets, metal spoons and forks, and the ash and soot rakes. The strip of wood that supports the open lid provides a place for hooks or nails to hold the utensils.

A baffle board (11) keeps the wood from falling out when the front doors are open, and makes it easy to remove wood bark and dirt that accumulates. The kindling box (14) rests on cleats and may be tilted or taken out in cleaning.

On the left side of the box is a shallow rack to hold papers for starting the fire.

Castors make it easy to move the box for cleaning or to roll it to the door for filling.

Since the wood box cabinet needs to be set out from the wall 18 inches to be in line with the range, there is enough space behind it for a utility cabinet. Cabinets 7040, 7041, and 7042 have been designed to fit in the space.

Serving Cabinet (7037)

This cabinet is to take the place of the wood box when the range is gas or electric. The top provides a serving counter, and there is drawer and cupboard space underneath for utensils used at the range.

Wall Cabinet (7038)

On the top shelf of this wall cabinet, planned for use at the range, a file compartment with dividers (8) takes care of trays and platters. In the bottom section, the two shelves (5) are adjustable so the space can be adapted to different storage needs. The

narrow shelf (10) below the cabinet is designed for seasonings. It may be omitted.

Wall cabinet 7038 can be used with base cabinet 7036 or 7037. When used with 7036—the wood box, which is set out 18 inches from the wall—a utility cabinet (7040, 7041, 7042) is needed to form a wall for hanging the overhead cabinet. If serving cabinet 7037 is used instead of the wood box, the wall cabinet is hung directly on the wall of the kitchen.

Storage Cabinet

PLAN 7039

In this floor-to-ceiling cabinet may be stored extra food supplies, the churn, milk pails, crocks, canning equipment, the picnic basket, and numerous other articles not in frequent use.

The cabinet can be used in the kitchen itself or in an alcove or wide hall. The dimensions, 48" x 24" x 88", can easily be changed to fit available space. If space in front of the cabinet is limited, a double instead of a single door may be used.

The shelves as shown are fixed. If cut from plywood they can be made adjustable.

Racks on the door provide a handy place for small articles.

The floor of the cabinet is the room floor, so heavy articles can be slid in and out without lifting. For reaching the top shelves, a small sturdy step box is shown on the plan.

Utility, Food Storage, and Chore Clothes Cabinets

PLANS 7040, 7041, 7042

These are floor-to-ceiling cabinets designed to be used with wood box cabinet 7036 and wall cabinet 7038. Any one of the three may be chosen for the purpose, depending on the kind of storage needed. The cabinets can also be used as separate units.

Utility and Food Storage Cabinet (7040)

This cabinet, planned especially for storage of extra staple foods, also provides space where the kitchen apron and a sweater or two can be hung. The drawer at the bottom can be used for picnic supplies, paper sacks, wrapping paper, or seldom-used articles.

Utility Cabinet (7041)

Designed with dividers (8) for storage of table leaves and the ironing board, this cabinet also has hooks for kitchen aprons and shelf and drawer space for other articles.

Chore Clothes Cabinet (7042)

This cabinet is planned to hold the chore clothes in daily use. It is ventilated by holes in the side panels (1, 2) so heat from the range will dry damp clothes and warm them for outdoor wear.

A slotted shoe rack (10) keeps wet and muddy boots and shoes off the cabinet floor. Overhead shelf (7) and hat rack (15) take care of hats and caps. A rack (8) on the door holds mittens and gloves. At the bottom of the cabinet is a 6-inch drawer that might be used for shoe cleaning supplies or for small toys. The floor above the drawer makes a practical step for a child to use when hanging coats and caps on the hooks inside the cabinet.

Acknowledgement

Cabinets designed by Geraldine Orrell
Bureau of Human Nutrition and Home Economics
Agricultural Research Administration
U. S. Department of Agriculture

7040, 7041, OR 7042
UTILITY, FOOD STORAGE, OR
CHORE CLOTHES CABINET

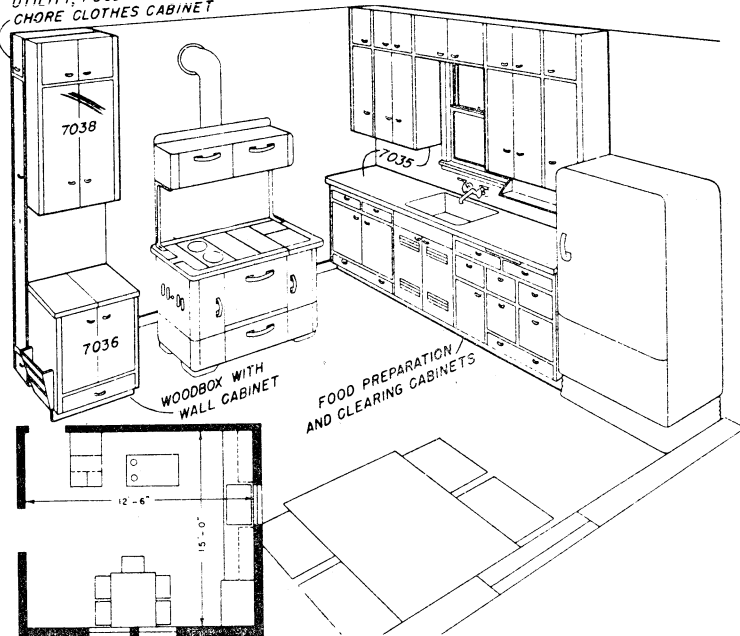

PLAN

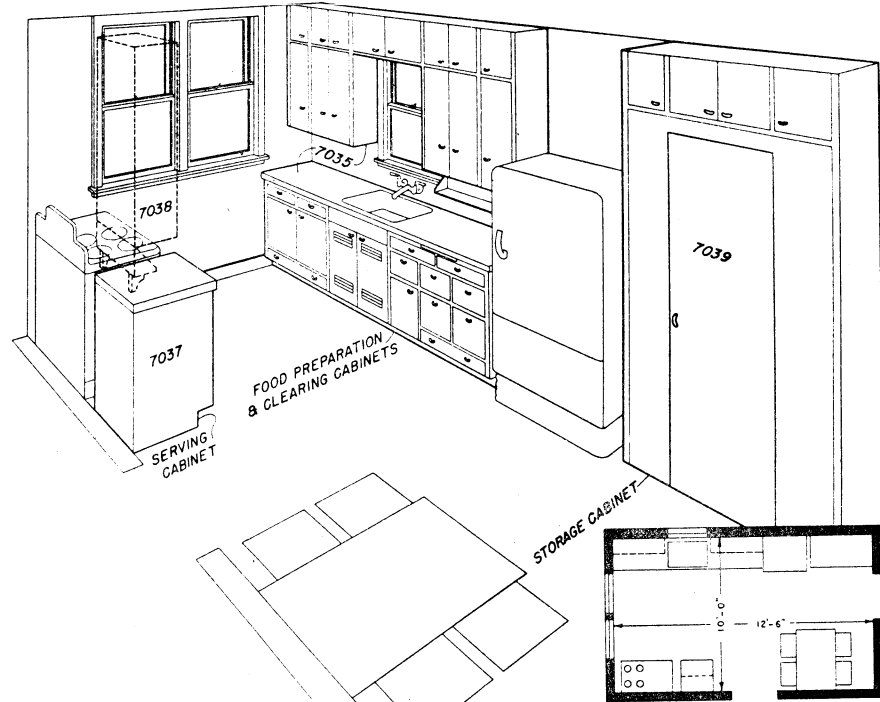

PLAN

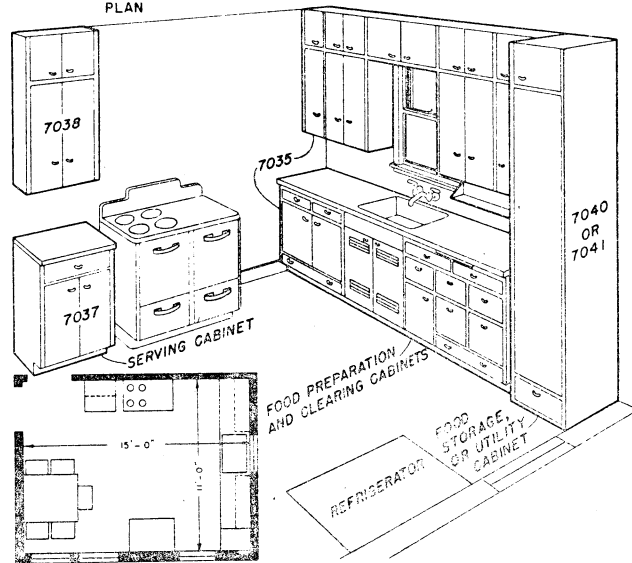

PLAN

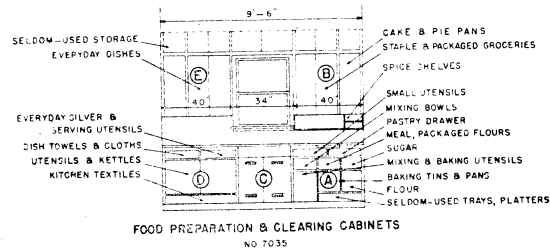

FOOD PREPARATION & CLEARING CABINETS
NO. 7035

NOTE: Working drawings are available for each of the cabinets illustrated except the small cabinets in the ceiling for storage of seldom used articles.

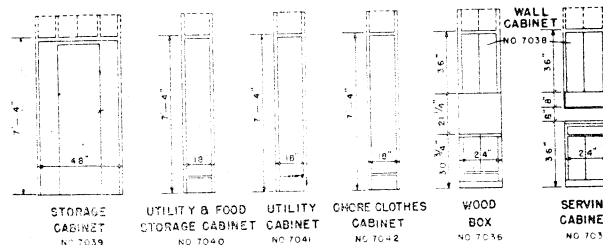

STORAGE CABINET NO. 7039
UTILITY & FOOD STORAGE CABINET NO. 7040
UTILITY CABINET NO. 7041
CHORE CLOTHES CABINET NO. 7042
WOOD BOX NO. 7036
WALL CABINET NO. 7038
SERVING CABINET NO. 7037

COOPERATIVE EXTENSION WORK IN
AGRICULTURE AND HOME ECONOMICS

AND
UNITED STATES DEPARTMENT OF AGRICULTURE COOPERATING

**HOME BUILT KITCHEN CABINETS
SUGGESTED KITCHEN ARRANGEMENTS**

USDA 47 EX 7034 SHEET 1 OF 1

DESIGNED BY BUREAU OF HUMAN NUTRITION
AND HOME ECONOMICS, USDA

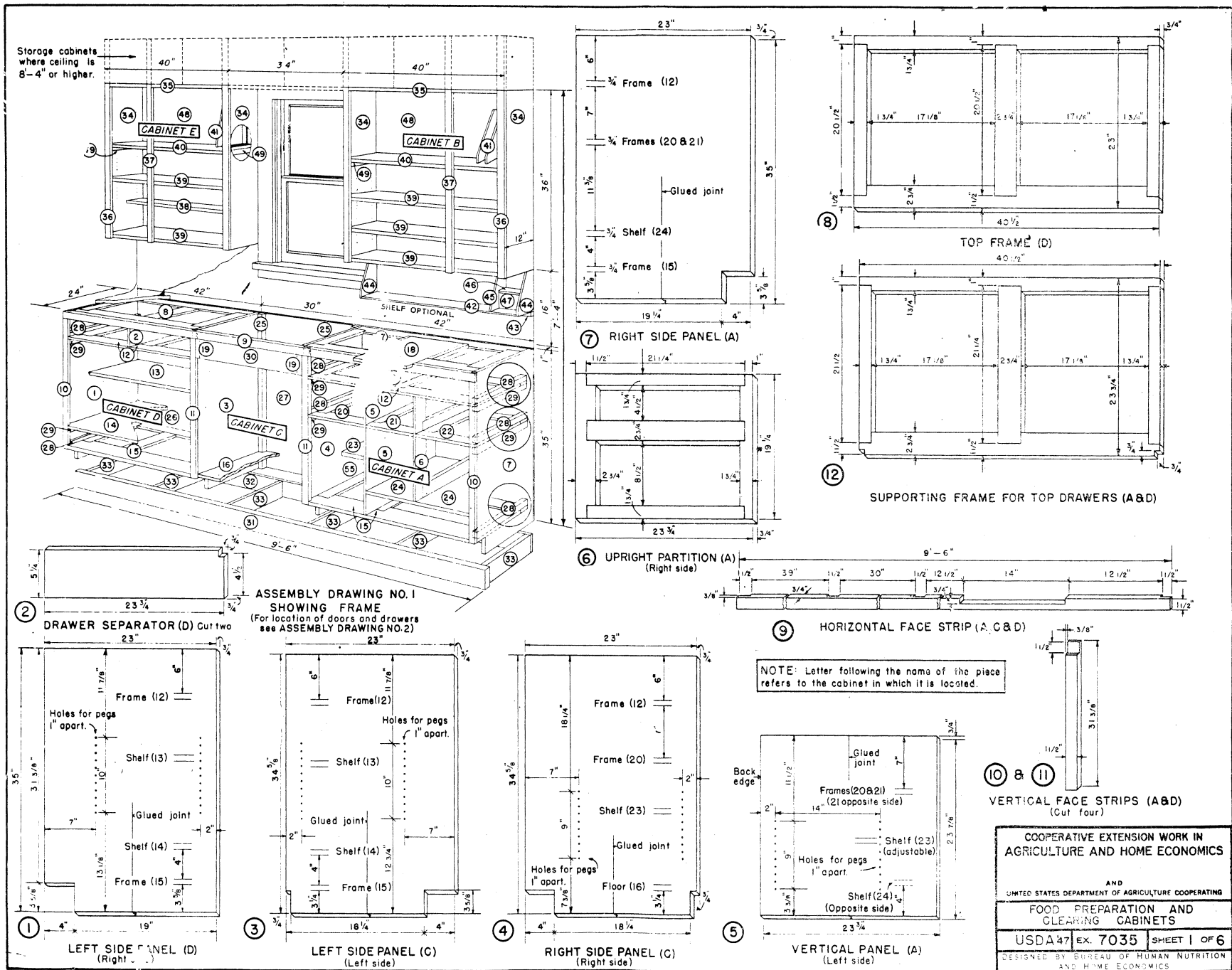

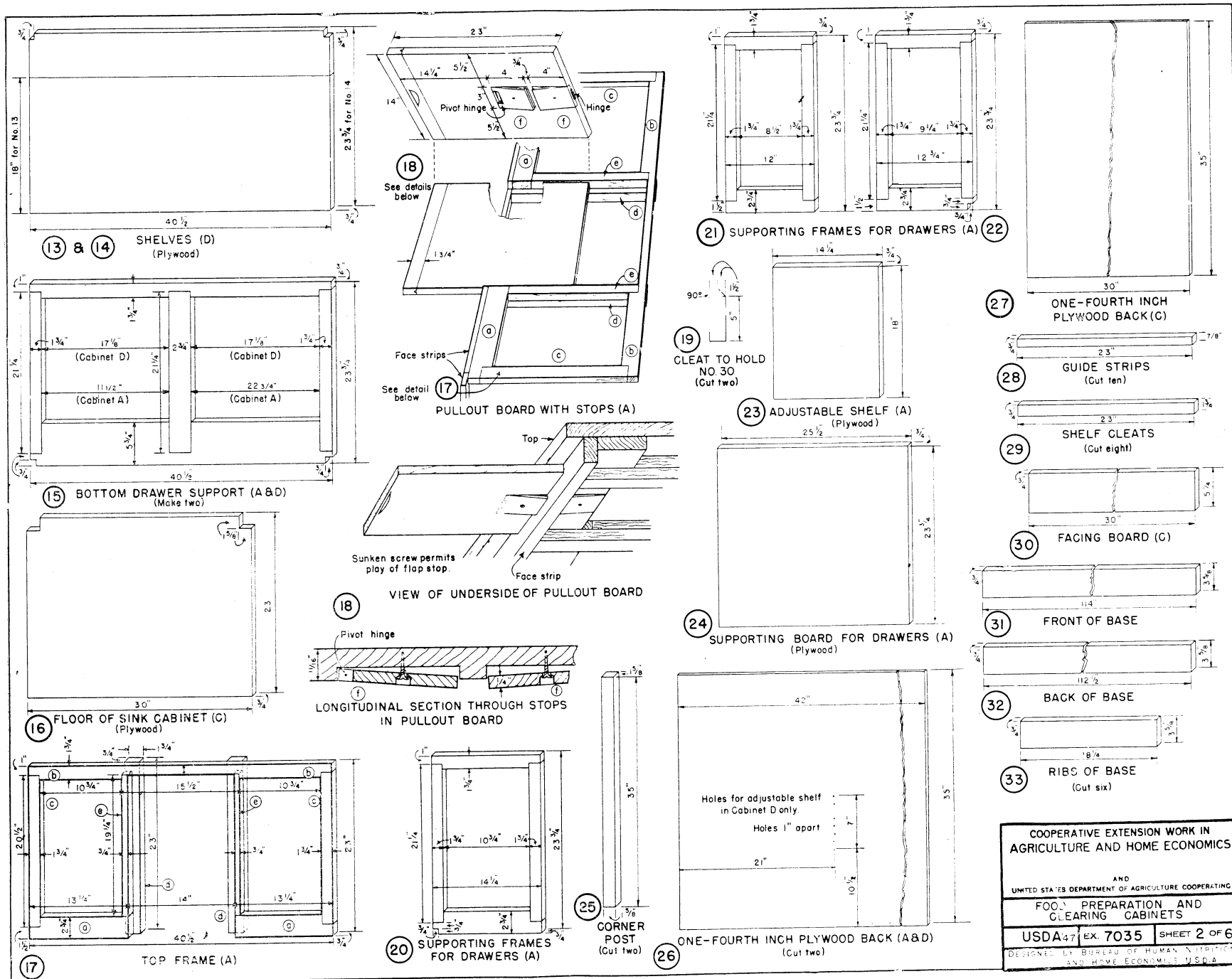

COOPERATIVE EXTENSION WORK IN
AGRICULTURE AND HOME ECONOMICS

AND
UNITED STATES DEPARTMENT OF AGRICULTURE COOPERATING

FOOD PREPARATION AND
CLEANING CABINETS

USDA 471 EX. 7035 SHEET 2 OF 6

DESIGNED BY BUREAU OF HUMAN NUTRITION
AND HOME ECONOMICS, USDA

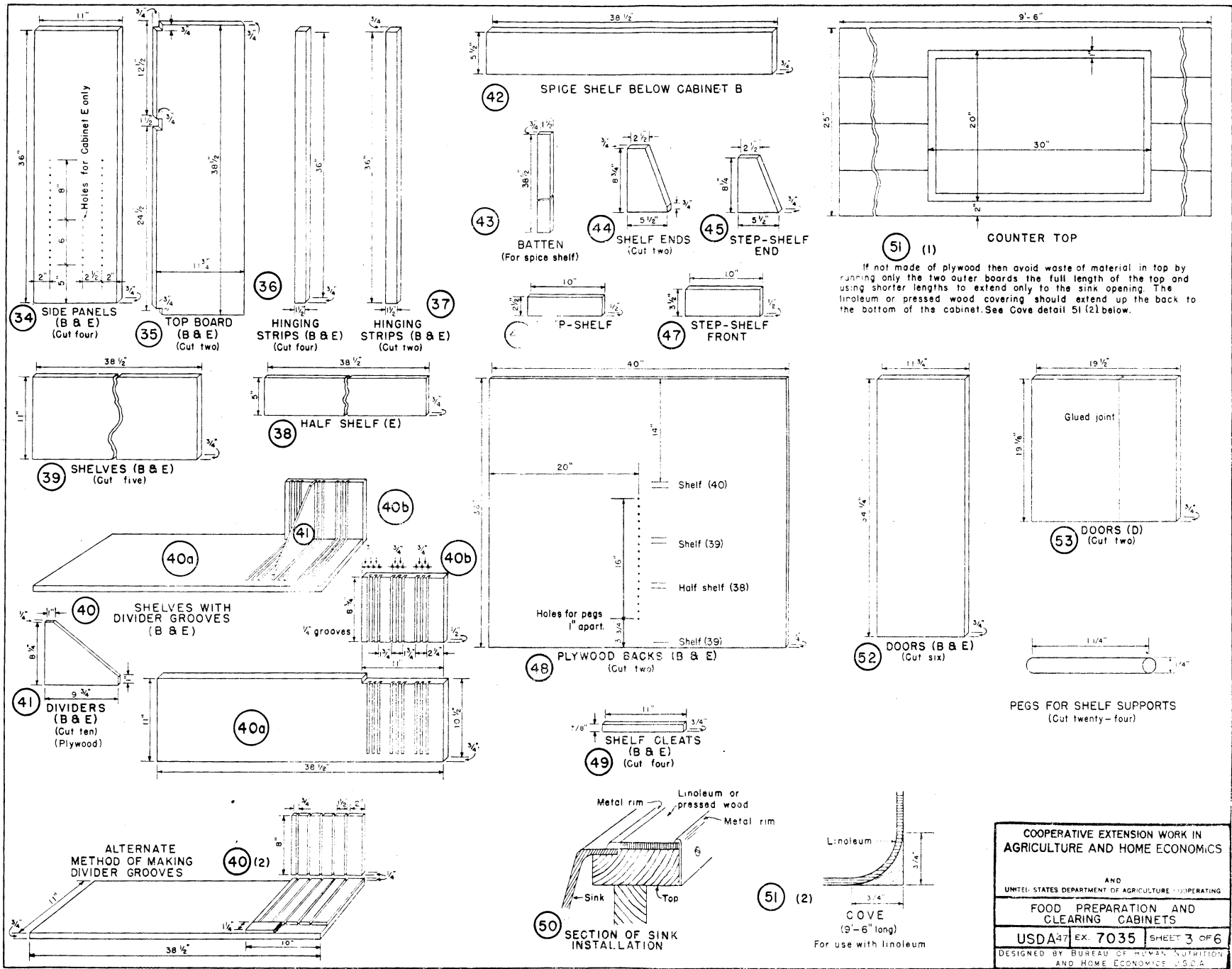

COOPERATIVE EXTENSION WORK IN
 AGRICULTURE AND HOME ECONOMICS

AND
 UNITED STATES DEPARTMENT OF AGRICULTURE COOPERATING

FOOD PREPARATION AND
 CLEARING CABINETS

USDA 47 EX. 7035 SHEET 3 OF 6

DESIGNED BY BUREAU OF HUMAN NUTRITION
 AND HOME ECONOMICS, USDA

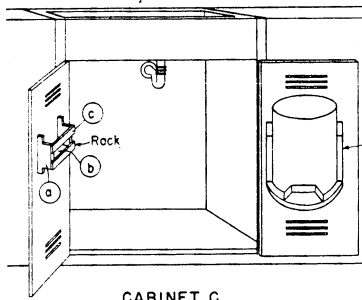

CABINET C

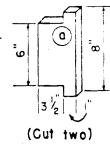

(Cut two)

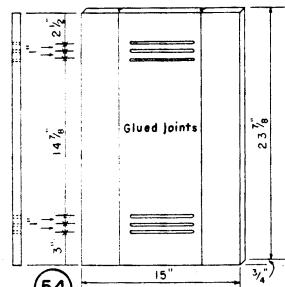

54

VENTILATED DOOR TO CABINET C
(Cut two)

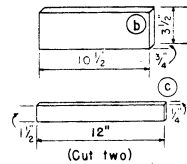

RACK PIECES

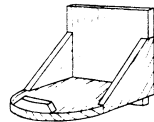

(Cut two)

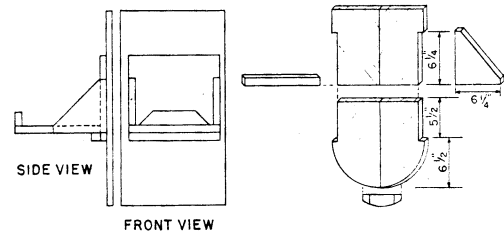

GARBAGE PAIL HOLDER

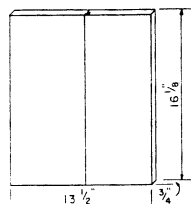

55

DOOR TO CABINET A

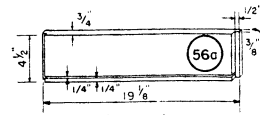

(Cut four)

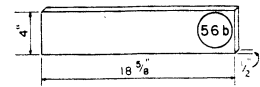

(Cut four)

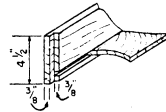

56

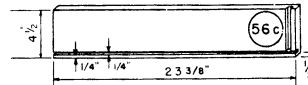

(Cut eight)

DETAILS OF TOP DRAWERS (A&D)

(BUILD FOUR) PLYWOOD BOTTOM 18 5/8 x 23 3/4.

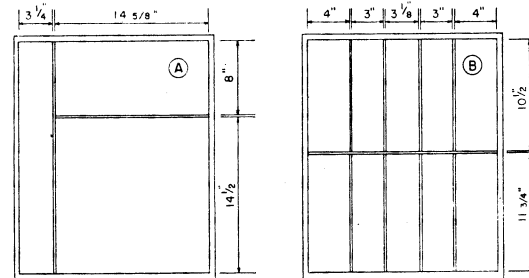

56

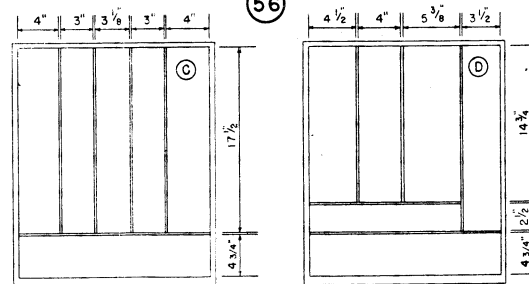

INTERIOR ARRANGEMENT OF DRAWERS 56 A,B,C,D

All plywood dividers 1/4 thick by 2" high. Back and side panels of drawers 1/2 thick. Front panel of drawer 3/4 thick. All-over dimension of drawer 19 1/8 x 23 3/4 x 4 1/2.

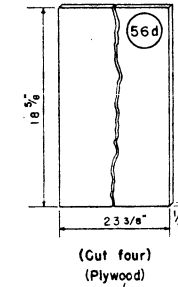

(Cut four)
(Plywood)

LUMBER

No. pine		pc.
1" x 12" x 14'-0"	-----	1 pc.
1" x 12" x 12'-0"	-----	5 "
1" x 12" x 10'-0"	-----	2 "
1" x 8" x 10'-0"	-----	4 "
1" x 8" x 8'-0"	-----	2 "
1" x 6" x 14'-0"	-----	1 "
1" x 6" x 16'-0"	-----	1 "
1" x 4" x 10'-0"	-----	3 "
1" x 4" x 8'-0"	-----	1 "
1" x 3" x 14'-0"	-----	1 "
1" x 3" x 10'-0"	-----	1 "
1" x 2" x 14'-0"	-----	5 "
1" x 2" x 12'-0"	-----	3 "
1" x 2" x 10'-0"	-----	1 "
1" x 2" x 8'-0"	-----	1 "
1/2" x 12" x 12'-0"	-----	1 "
1/2" x 8" x 10'-0"	-----	1 "
1/2" x 6" x 14'-0"	-----	2 "
1/2" x 6" x 8'-0"	-----	1 "
Wood dowels, 1/4" x 3'-0"	-----	1 "
Plywood		
3/4" x 4'-0" x 8'-0"	-----	1 "
1/4" x 4'-0" x 8'-0"	-----	4 "
Linoleum or pressed wood		
		35 sq. ft.

HARDWARE

Hinges, 1 1/2" x 1 1/2"	-----	11 pr.
Door pulls	-----	11
Drawer pulls	-----	13
Friction catches	-----	11
Finishing nails, 4d	-----	2 lb.
" " 6d	-----	3 "
Wood screws, No. 8 1 1/2"	-----	1 gross
" " No. 4 1/2"	-----	4 doz.
Metal edging (counter)	-----	14 lin. ft.
" " (sink)	-----	10 "
Galvanized iron (28 ga.)	-----	
or Tin (10 lb.)	-----	25 sq. ft.

COOPERATIVE EXTENSION WORK IN
AGRICULTURE AND HOME ECONOMICS

AND
UNITED STATES DEPARTMENT OF AGRICULTURE COOPERATING

FOOD PREPARATION AND
CLEANING CABINETS

USDA 47 EX. 7035 SHEET 4 OF 6

DESIGNED BY BUREAU OF HUMAN NUTRITION
AND HOME ECONOMICS U.S.D.A.

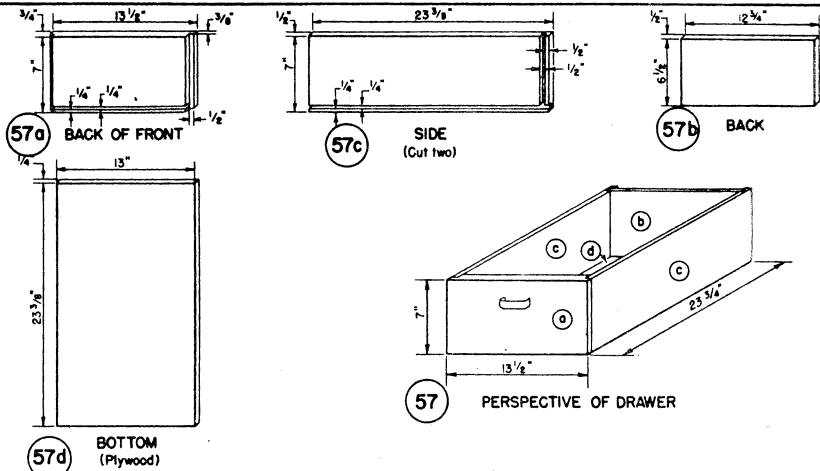

57 PERSPECTIVE OF DRAWER

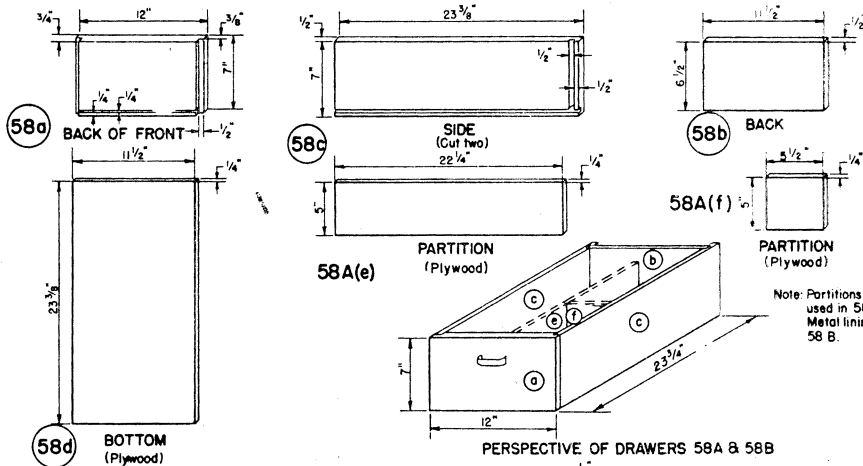

PERSPECTIVE OF DRAWERS 58A & 58B

Note: Partitions e and f used in 58A only. Metal lining used in 58B.

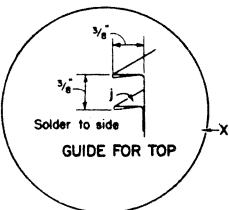

GUIDE FOR TOP

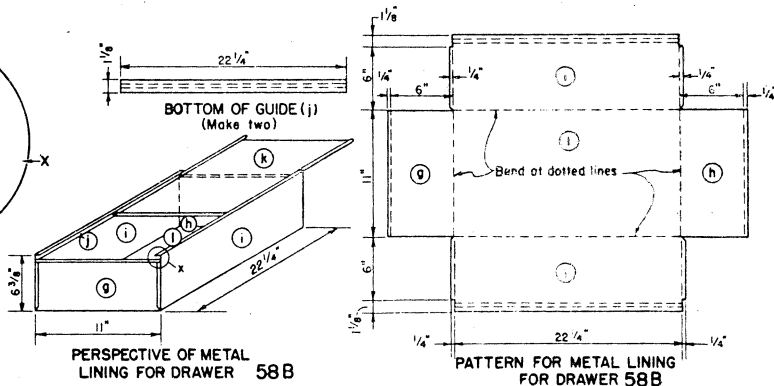

PERSPECTIVE OF METAL LINING FOR DRAWER 58B

PATTERN FOR METAL LINING FOR DRAWER 58B

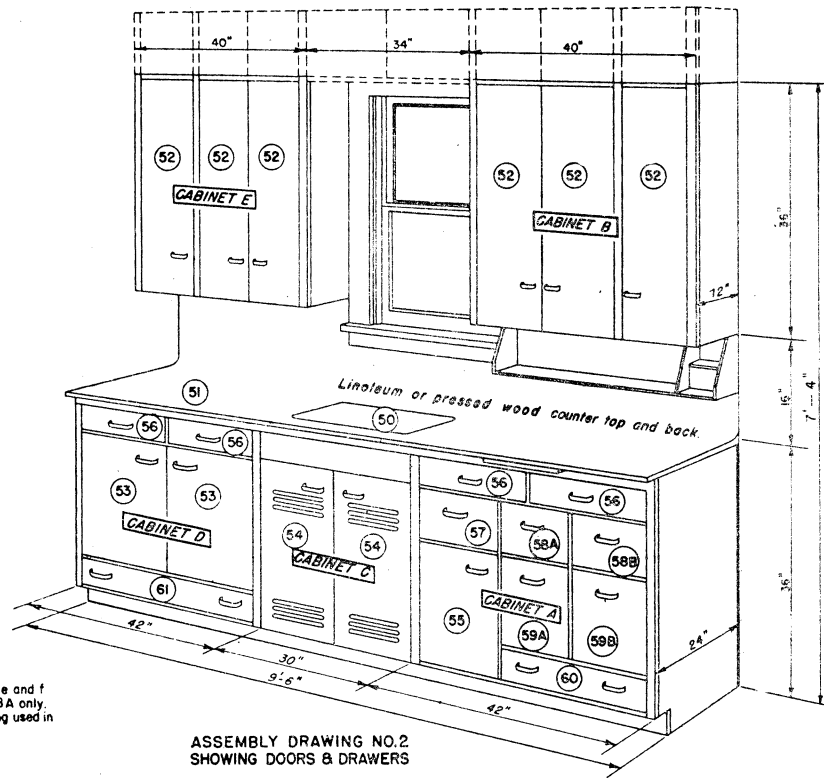

ASSEMBLY DRAWING NO. 2
SHOWING DOORS & DRAWERS

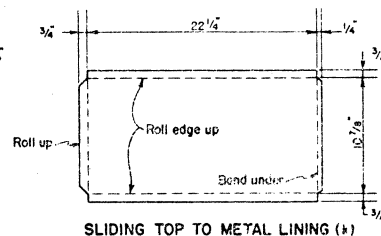

SLIDING TOP TO METAL LINING (h)

Note: Use 28 ga. galvanized iron or 10 lb. tin for metal linings.

COOPERATIVE EXTENSION WORK IN AGRICULTURE AND HOME ECONOMICS		
AND UNITED STATES DEPARTMENT OF AGRICULTURE COOPERATING		
FOOD PREPARATION AND CLEANING CABINETS		
USDA 47	EX. 7035	SHEET 5 OF 6
DESIGNED BY BUREAU OF HUMAN NUTRITION AND HOME ECONOMICS U.S.D.A.		

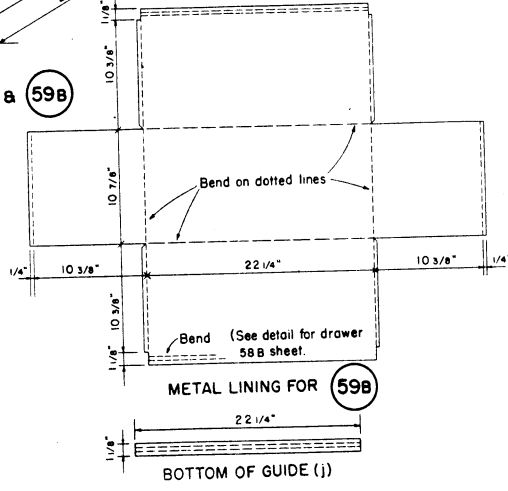
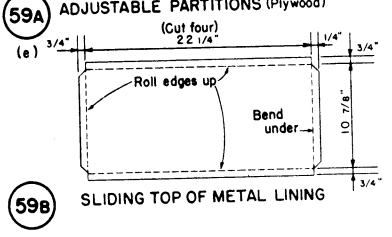
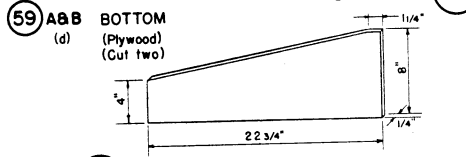
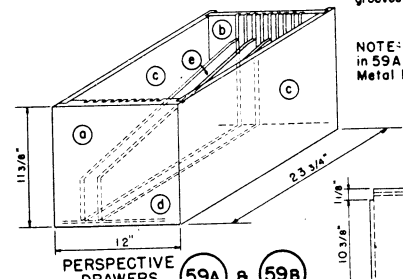
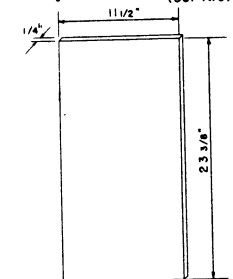
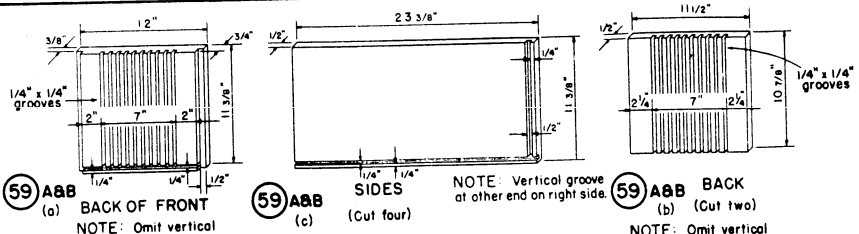

NOTE: Metal for lining to be 28 ga. galvanized iron or 10 lb. tin.

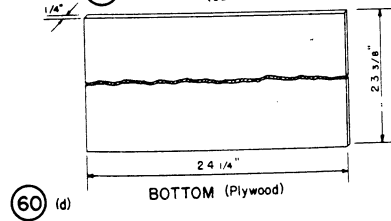
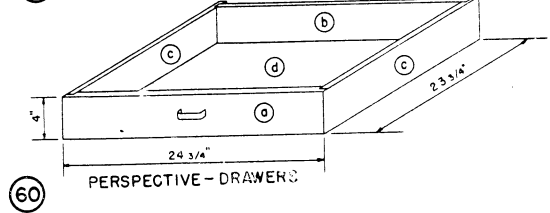
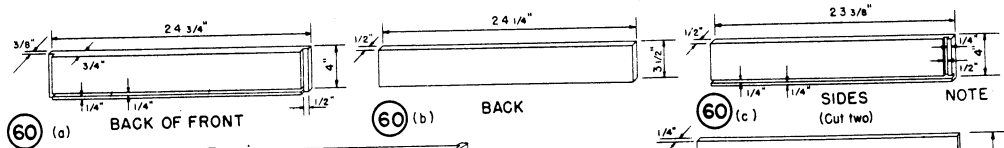
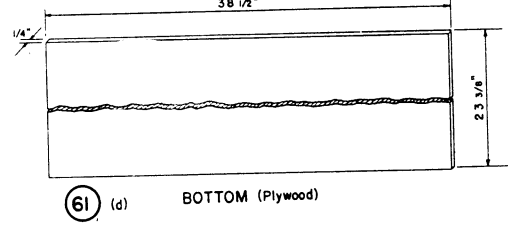
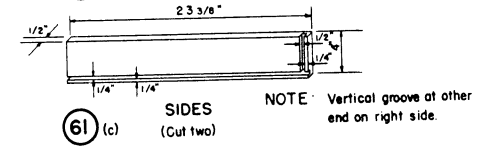
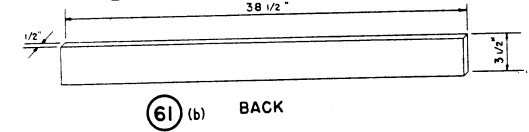
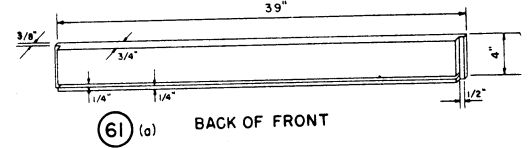
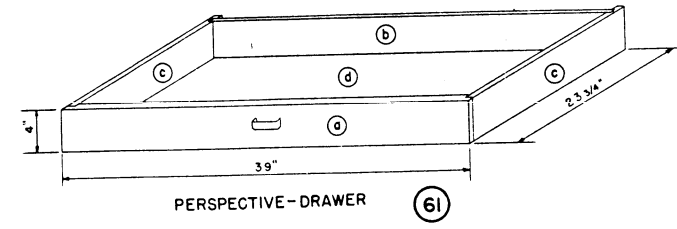

COOPERATIVE EXTENSION WORK IN
AGRICULTURE AND HOME ECONOMICS

AND
UNITED STATES DEPARTMENT OF AGRICULTURE COOPERATING

FOOD PREPARATION AND
CLEARING CABINETS

USDA 47 EX 7035 SHEET 6 OF 6

DESIGNED BY BUREAU OF HUMAN NUTRITION
AND HOME ECONOMICS, U.S.A.

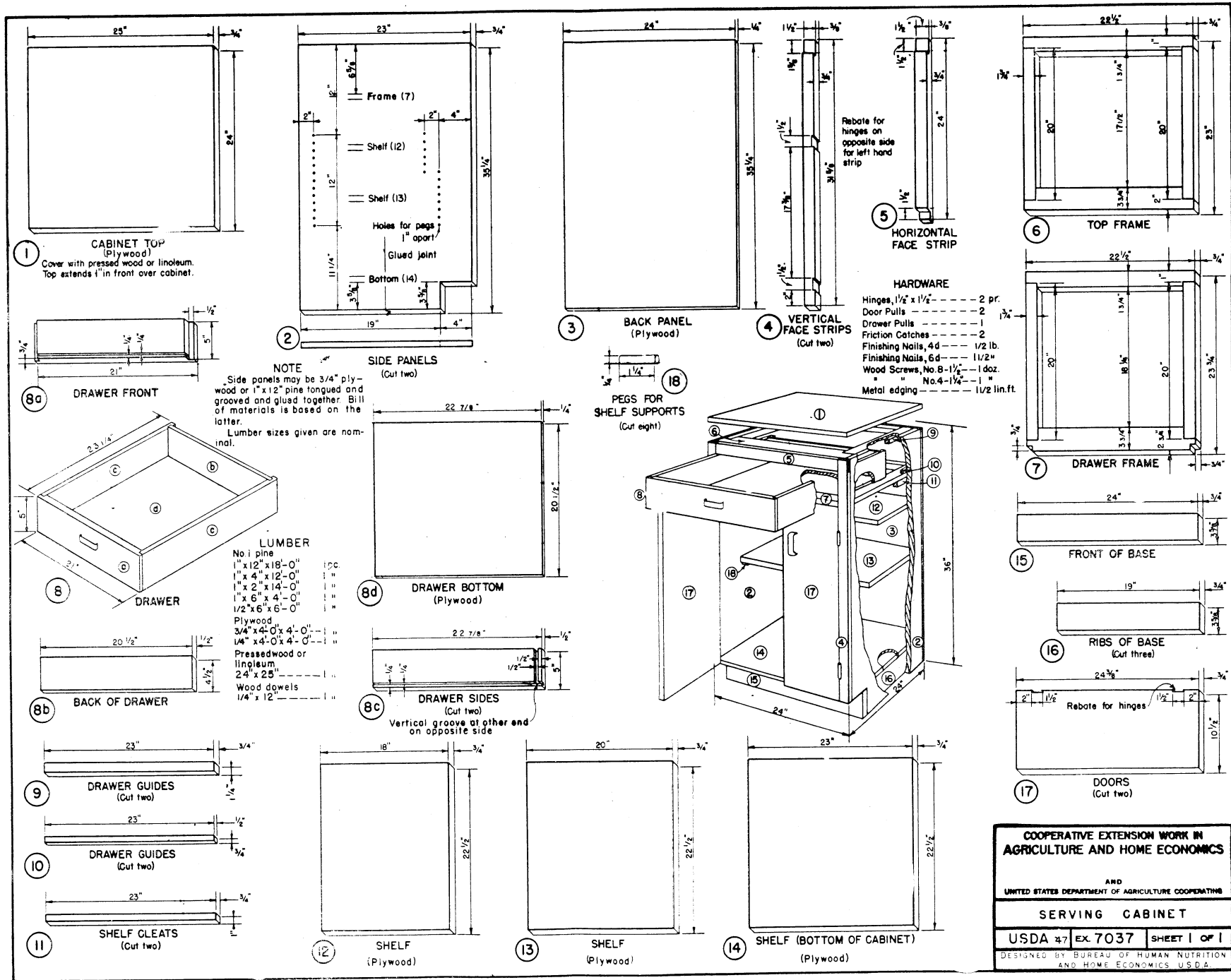

1 CABINET TOP
(Plywood)
Cover with pressed wood or linoleum.
Top extends 1" in front over cabinet.

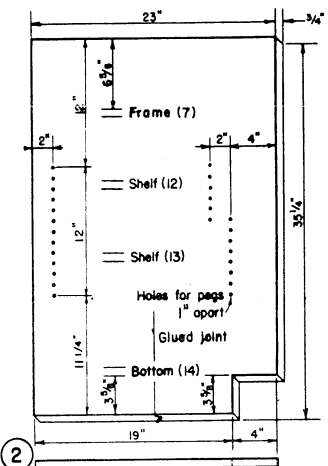

2 SIDE PANELS
(Cut two)

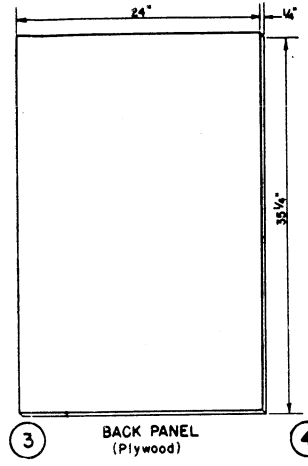

3 BACK PANEL
(Plywood)

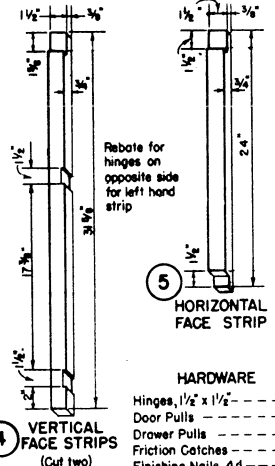

4 VERTICAL
FACE STRIPS
(Cut two)

- HARDWARE**
- Hinges, 1/2" x 1 1/2" --- 2 pr.
 - Door Pulls --- 2
 - Drawer Pulls --- 1
 - Friction Catches --- 2
 - Finishing Nails, 4d --- 1/2 lb.
 - Finishing Nails, 6d --- 1/2 lb.
 - Wood Screws, No. 8-1 1/2" --- 1 doz.
 - " " No. 4-1 1/4" --- 1 "
 - Metal edging --- 1 1/2 lin.ft.

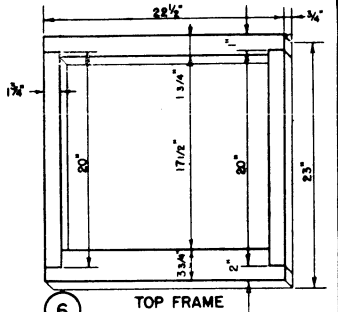

6 TOP FRAME

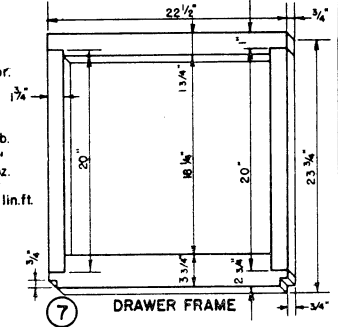

7 DRAWER FRAME

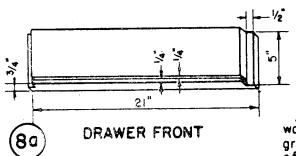

8a DRAWER FRONT

NOTE
Side panels may be 3/4" ply-
wood or 1" x 12" pine tongued and
grooved and glued together. Bill
of materials is based on the
latter.
Lumber sizes given are nomi-
nal.

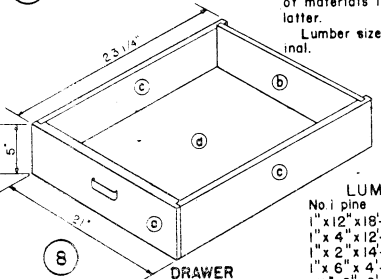

8 DRAWER

- LUMBER**
- No. 1 pine
 - 1" x 12" x 18'-0" --- 1 pc.
 - 1" x 4" x 12'-0" --- 1 "
 - 1" x 2" x 14'-0" --- 1 "
 - 1" x 6" x 4'-0" --- 1 "
 - 1/2" x 6" x 6'-0" --- 1 "
 - Plywood
 - 3/4" x 4'-0" x 4'-0" --- 1 "
 - 1/4" x 4'-0" x 4'-0" --- 1 "
 - Pressed wood or
linoleum
 - 24" x 25" --- 1 "
 - Wood dowels
 - 1/4" x 12" --- 1 "

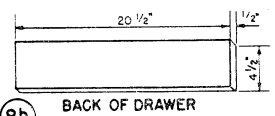

8b BACK OF DRAWER

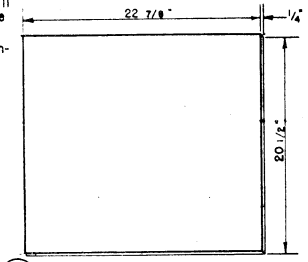

8d DRAWER BOTTOM
(Plywood)

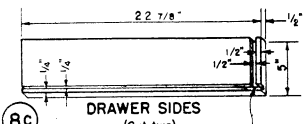

8c DRAWER SIDES
(Cut two)
Vertical groove at other end
and on opposite side

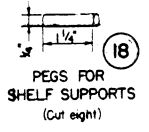

18 PEGS FOR
SHELF SUPPORTS
(Cut eight)

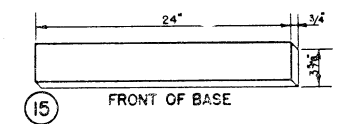
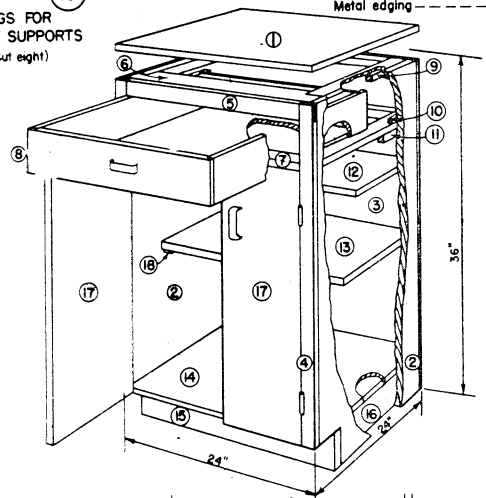

15 FRONT OF BASE

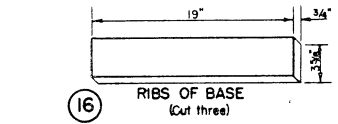

16 RIBS OF BASE
(Cut three)

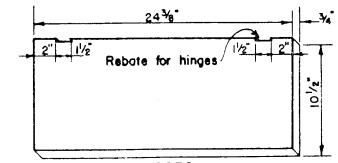

17 DOORS
(Cut two)

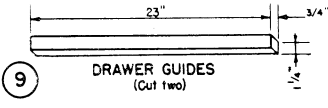

9 DRAWER GUIDES
(Cut two)

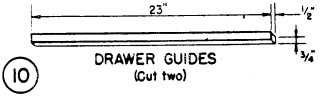

10 DRAWER GUIDES
(Cut two)

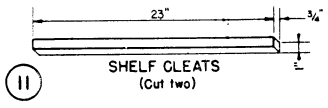

11 SHELF CLEATS
(Cut two)

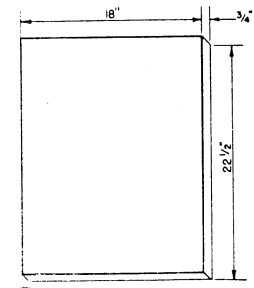

12 SHELF
(Plywood)

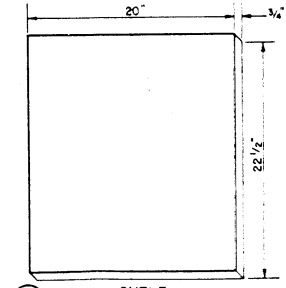

13 SHELF
(Plywood)

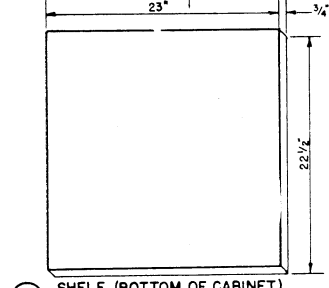

14 SHELF (BOTTOM OF CABINET)
(Plywood)

**COOPERATIVE EXTENSION WORK IN
AGRICULTURE AND HOME ECONOMICS**

AND
UNITED STATES DEPARTMENT OF AGRICULTURE COOPERATING

SERVING CABINET

USDA #7 EX. 7037 SHEET 1 OF 1

DESIGNED BY BUREAU OF HUMAN NUTRITION
AND HOME ECONOMICS, U.S.D.A.

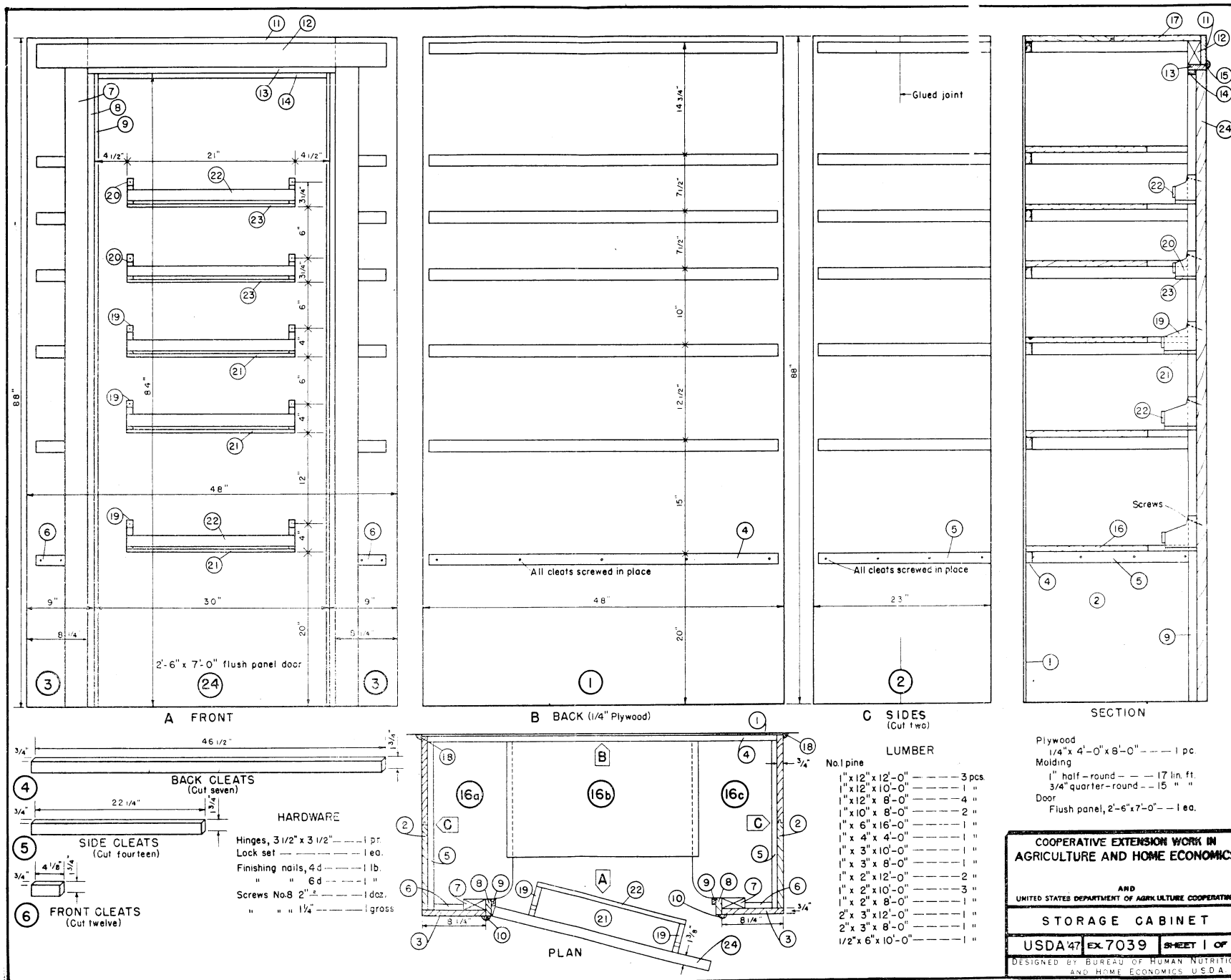

Dead storage where ceiling is 8'-4" or higher

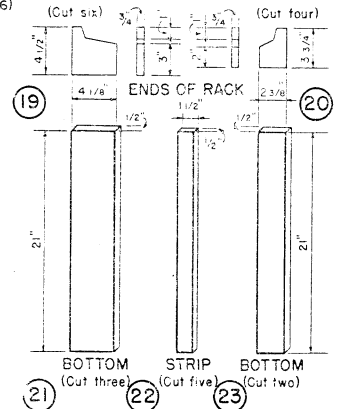
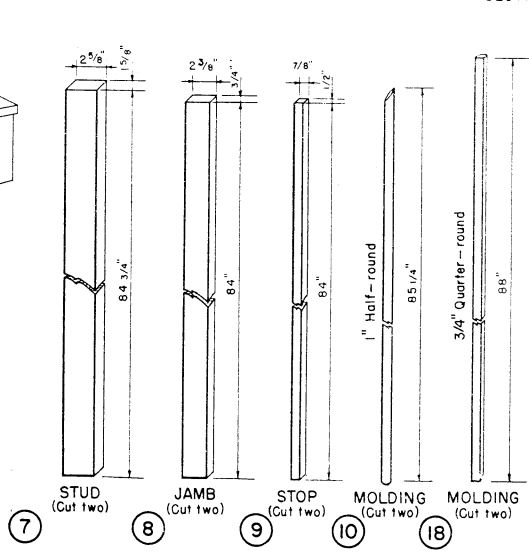
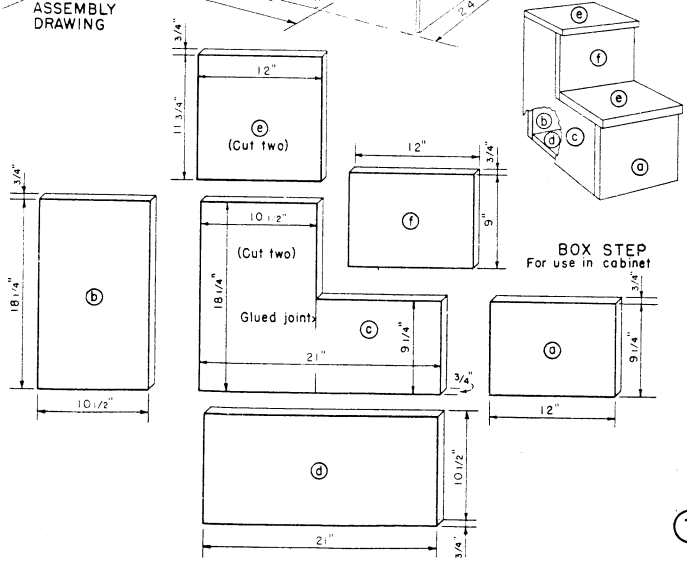
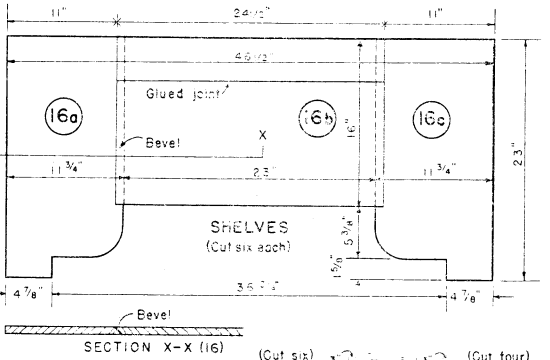
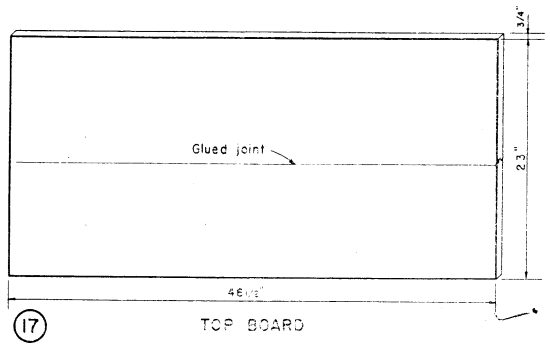
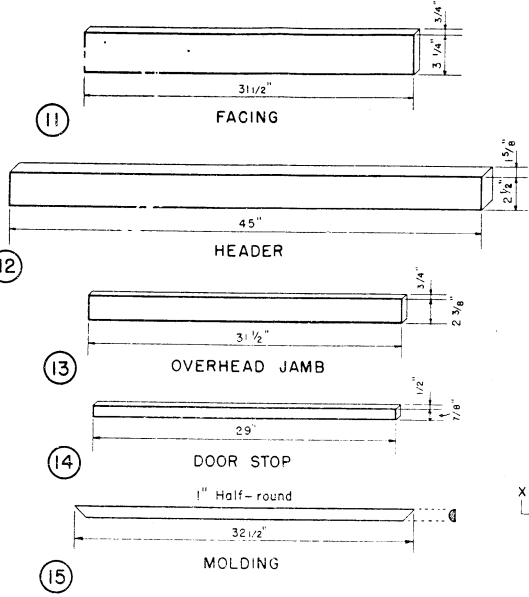

COOPERATIVE EXTENSION WORK IN AGRICULTURE AND HOME ECONOMICS
AND UNITED STATES DEPARTMENT OF AGRICULTURE COOPERATING
STORAGE CABINET
USDA 47 EX. 7039 SHEET 2 OF 2
DESIGNED BY BUREAU OF HUMAN NUTRITION AND HOME ECONOMICS - USDA

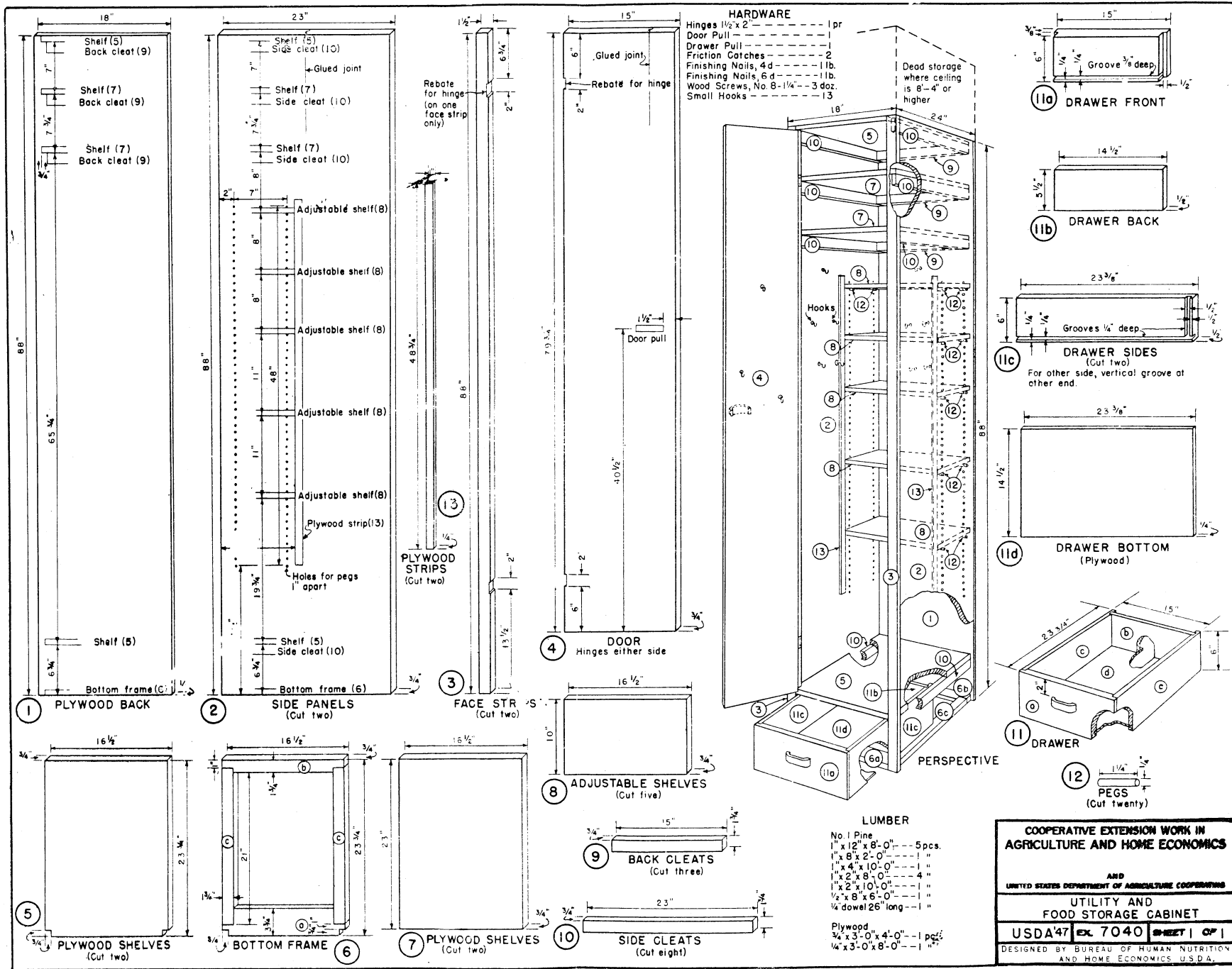

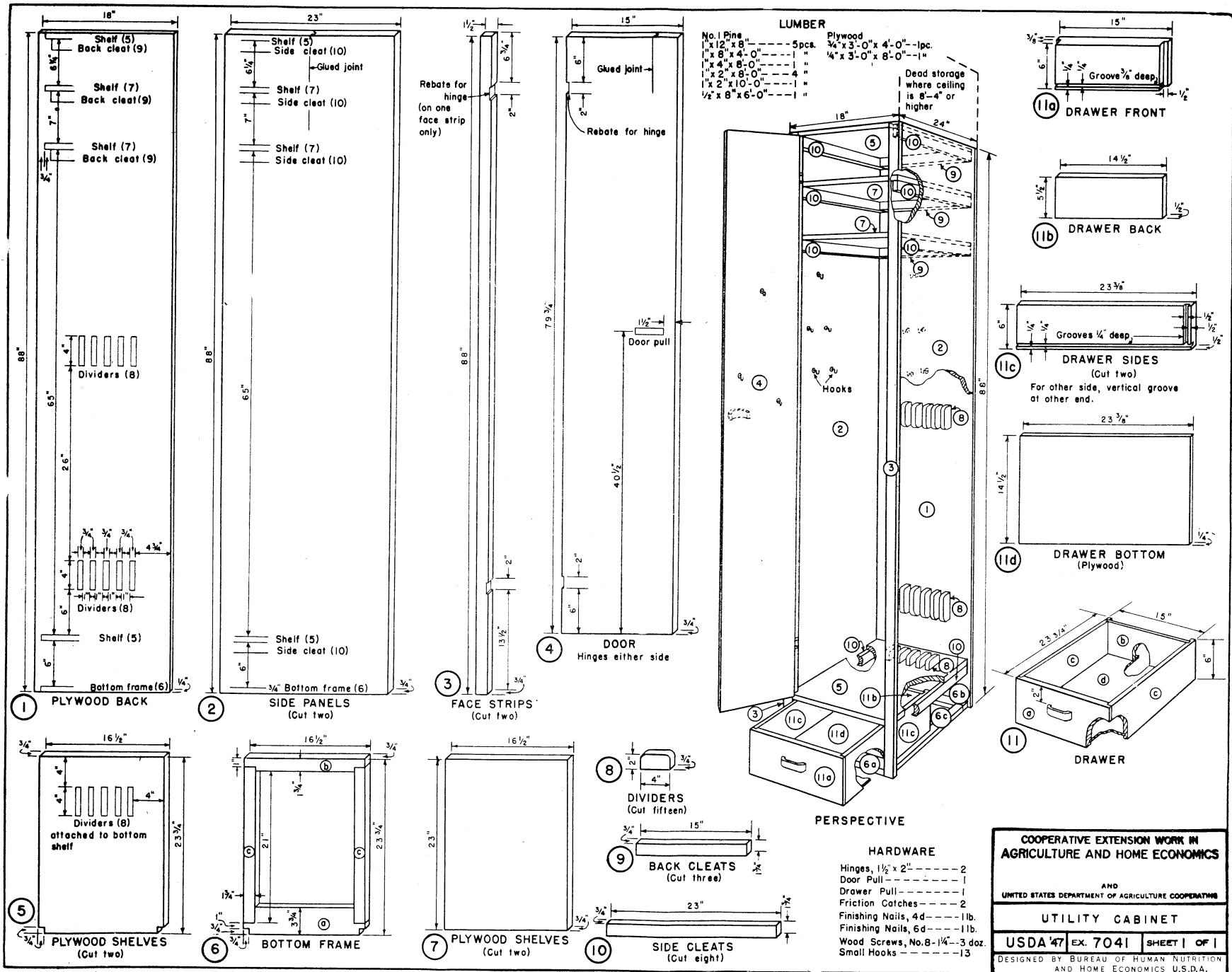

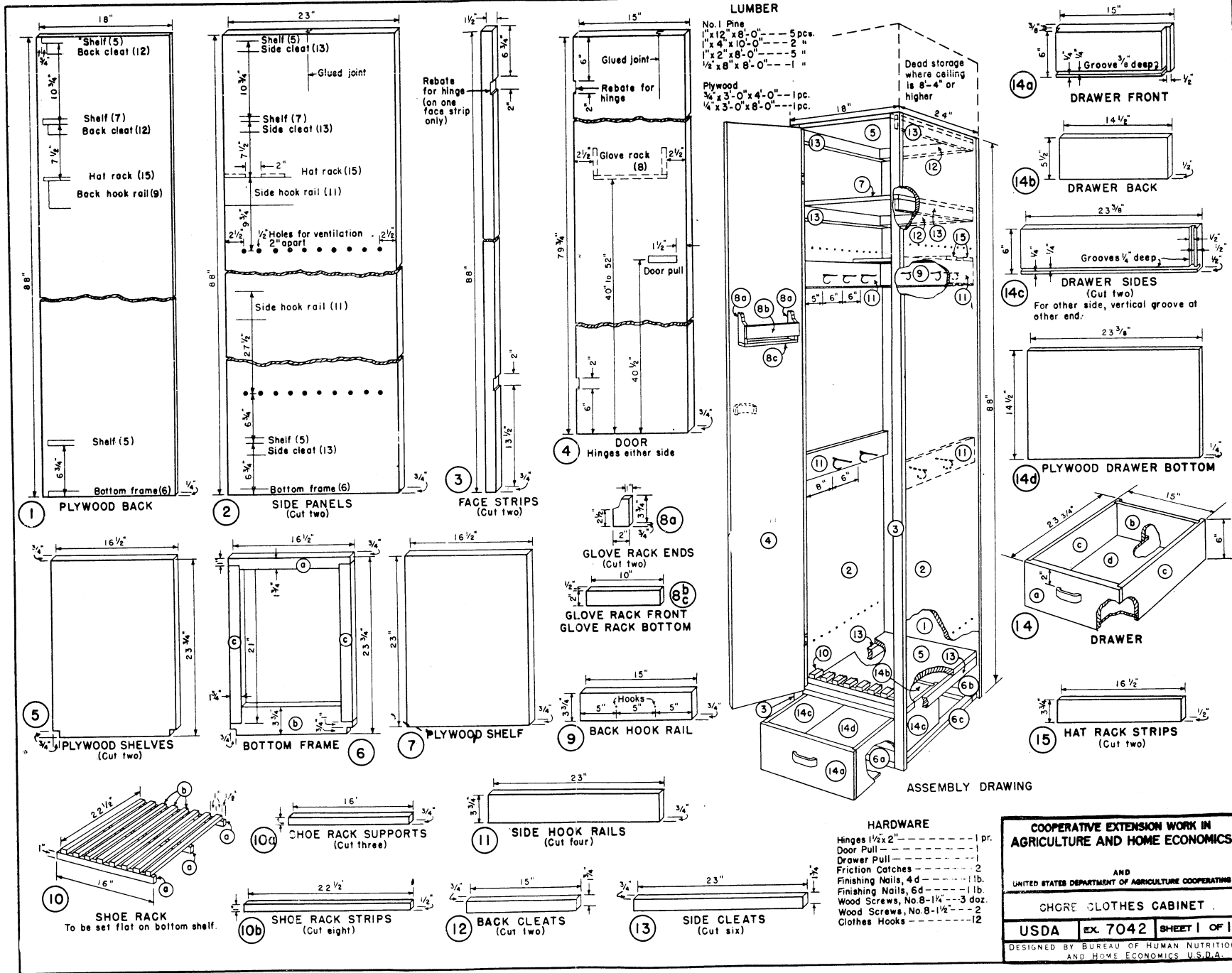

**Cooperative Extension Work in Agriculture and Home Economics.
The Oklahoma A. and M. College and the United States
Department of Agriculture Cooperating. Distributed
in Furtherance of the Acts of Congress of
May 8 and June 30, 1914.**