

Scintillation Detector for Gamma Spectroscopy

Anh Than

Department of Electrical and
Computer Engineering
Oklahoma State University
Stillwater, Oklahoma
anh.than@okstate.edu

Conor Henry

Department of Electrical and
Computer Engineering
Oklahoma State University
Stillwater, Oklahoma
conor.henry@okstate.edu

Haley Welch

Department of Electrical and
Computer Engineering
Oklahoma State University
Stillwater, Oklahoma
haley.welch10@okstate.edu

Stephen Ivanusic

Department of Electrical and
Computer Engineering
Oklahoma State University
Stillwater, Oklahoma
stephen.ivanusic@okstate.edu

Abstract (Stephen Ivanusic)— This project is documentation of a scintillator radiation detector for gamma spectroscopy. Gamma radiation causes a scintillator crystal to illuminate, which is captured and converted to an electrical signal. The detector works by measuring electrical pulses from the output of a photomultiplier tube (PMT). The amplitude of these pulses is proportional to the energy of the radiation. By creating a histogram with x-axis of energy and y axis of “# of counts” the energy spectrum of the radiation can be identified and analyzed.

Keywords—*scintillation, radiation, multi-channel analyzer, photomultiplier*

I. INTRODUCTION (STEPHEN IVANUSIC)

This paper will show the design process for creating a scintillation radiation detector for gamma spectroscopy. A scintillator is a material which fluoresces when excited by a gamma photon. The intensity of this visible flash of light is proportional to the energy of the photon, which allows for analysis of the energy spectrum of radiation sources. This is in contrast to a geiger counter, which can only show intensity in counts per second. The visible light emitted by the scintillator is fed into a photomultiplier by physically attaching the scintillator to the cathode end of the PMT (Photomultiplier Tube). The PMT is powered by high voltage, slightly more than 1kV, but requires very little current, less than one milliamp. Output pulses from the PMT are then amplified and fed into an MCA (Multi Channel Analyzer). This MCA device consists of a peak-and-hold circuit and ADC, which holds the very fast peaks at their maximum and records the values. A microprocessor is used to record and display these maximum peak values. A histogram graph of amplitudes vs. number of counts is shown on the display, which shows the energy spectrum of the radiation source. The specifications of this project state that the authors should have an instrument in a box with labelled switches or other controls and neat wiring inside. Due to the typically high price of scintillators and PMTs, the budget of \$300 is a notable constraint. Devices which are used for laboratory or security work can often cost anywhere from \$750-\$10000 or more. Applications of this device include gamma spectroscopy, which is used in nuclear

forensics, astrophysics data, medical analysis, and educational topics such as nuclear physics.

II. PRELIMINARY DESIGN

A. Project Disambiguation (ALL)

This section will clearly define which authors were responsible for the separate parts of the project. It should be noted that there was significant overlap between hardware worked on by Stephen Ivanusic and Conor Henry and software worked on by Anh Than and Haley Welch. Specific sections will be denoted here and will follow for the rest of the report.

Stephen Ivanusic was responsible for the scintillator, which entails choosing and testing multiple scintillators for accuracy and compatibility with the PMT. Stephen was also responsible for powering any and all devices within the project. This includes the main power input and any power conversion needed for internal electronics.

Conor Henry was responsible for the PMT, which entails choosing the correct PMT and socket to couple with the scintillator. Conor was also responsible for putting the housing together on the PMT and the housing for the all the electronic components, such as power supplies, display, and MCA.

Anh Than was responsible for the analog-to-digital-converter and the software, i.e., user interface. The user interface displayed the counts per seconds of detected photons, a histogram of the counts versus energy levels, and the spectrum of detected gamma photon energies. Anh also assisted Haley with the MCA.

Haley Welch was responsible for the program calculations and calibration and helping Anh Than with the user interface. Haley was also responsible for the MCA.

B. Research (ALL)

This section will cover the preliminary research topics and concerns of this project and will be separated by author as described in the 'Project Disambiguation' section II.A. Each author has written their own section. A block diagram of our initial project will be shown in the appendix of this report.

(Stephen Ivanusic) The main research goal with finding an adequate scintillator was to characterize all the different possible solutions. There are hundreds of different types of scintillators from plastics, crystals, organic and inorganic compounds, etc. Some of these scintillators have wildly different uses or constraints, such as hydrophobia or inherent background radiation. Research was done by learning the mechanism by which the scintillator functions. A scintillator functions because the high energy gamma photons will cause low energy photons to be knocked out of the lattice in various wavelengths. Next, research was done into scintillator types which would emit photons at a wavelength compatible with the PMT, which would be blue light at approximately 450nm. After these constraints, along with budget, were taken into consideration, Three scintillator types were chosen. The cheapest was a surplus plastic scintillator, the next was a LYSO crystal (Cerium doped Lutetium), and finally was NaI(Tl) (Thallium doped Sodium Iodide). Final results and decisions will be discussed later in the report.

(Stephen Ivanusic) Next for research was the various power supplies that would be required for the device. Initially, it was decided that the device should be able to be powered by USB or battery, both of which would be regulated to 5V DC. The pre-amplifier for the PMT required both +5V and -5V DC. Finally, the PMT itself required a minimum of 1000V DC. To satisfy all of these requirements, a Battery/USB breadboard board was purchased with a regulator built in for 5V DC. A MAX660 switched capacitor chip was used in an 'inverter' configuration for the -5V DC. A Charge pump voltage multiplier was found online by a company, RH Electronics, which could take 12V DC as input and produce variable 150V-1500V DC. A simple 5V-12V converter was used to power that device. After confirming that the breakout board could sufficiently power each device, they were purchased and assembled. Details about this will be discussed in a later section.

(Conor Henry) The focus in research was to find the appropriate PMT that could couple with the scintillator well. With PMTs, there are several different types, head on, side on, and different sizes. The photomultiplier uses the cathode to detect the photon coming from the scintillator, and then generates an electron. This electron is then multiplied off of multiple dynodes till it gets to the anode, and this is where our pulse that we read comes from. Knowing the scintillator would give off blue photons, the PMT had to be able to read the blue photons. Further research went into what type of PMT would be used. The head on type takes in the photons on the

top or end, whereas the side on type takes the photons on a certain side of the PMT. Researching PMTs that would be able to read blue light and had a head on cathode brought up Hamamatsu products. Next, research into Hamamatsu products brought up the PMT R6095, which had all the specifications needed, head on, able to read blue light, compact enough to hold in one hand and move if needed, and came with a socket that included a voltage divider for every PMT pin and pre amp.

(Conor Henry) Next was to research the housing needed for the PMT and the housing for the electronic components. The PMT cathode can not be exposed to outside light while powered on or it would break due to too much light. The PMT came with a metal housing so that you could hold the tube but left the cathode exposed. The cathode housing would have to be light tight and be able to fit the scintillator in order to secure it to the cathode. Two methods were found, a PVC pipe piece that could screw onto the the metal case of PMT with a thin metal sheet on the end to keep it light tight. The second method was to electrical tape the scintillator to the end of the metal casing and the cathode. Each method would work depending on the scintillator. The main research for the electrical components housing was to find a professional box that would be able to fit our components and be able to be cut for our display.

(Anh Than) Another part of research was to determine the type of ADC (analog-to-digital converter) needed. This was based on learning about the signal coming in from the PMT. The pulse width of the signal would be in the nanosecond range. Using the Nyquist Theorem, an ADC in the MegaHertz would be necessary to be able to completely reconstruct the signal. The typical ADC used for gamma spectroscopy is an MCA. However, most MCAs cost hundreds if not thousands of dollars. It was assumed that if the ADC could sample some points from the signal, then the rest of the signal could be put together through extrapolation. The MCP3008 was considered. It has a sampling rate of two hundred thousand samples per second and is a ten bit adc.

(Anh Than) Next was to determine the method of displaying the information. The MCP3008 uses SPI connection and is easily interfaceable with the Raspberry Pi 3 Model B+. It displayed to an LCD touchscreen. Programming the UI started with planning ahead for the specifications that had been given. It had to display the number of detected photons per second, a histogram with the counts versus the amplitudes of the energy levels, and the spectrum of gamma photon energies. Different python GUI frameworks were researched. 'tkinter', a Python 3 library, was ultimately used for the GUI. An image of the GUI is shown in "Fig. 1". It provided many useful functions for plotting data and arranging widgets. Each button allowed the user to access the information and easily switch to a different state. The Transient and Email buttons were functionalities that were not required by the project but added anyway. The Transient

button displayed a graph of the transient data for five seconds. The Email button sent an email with the most recently obtained data.

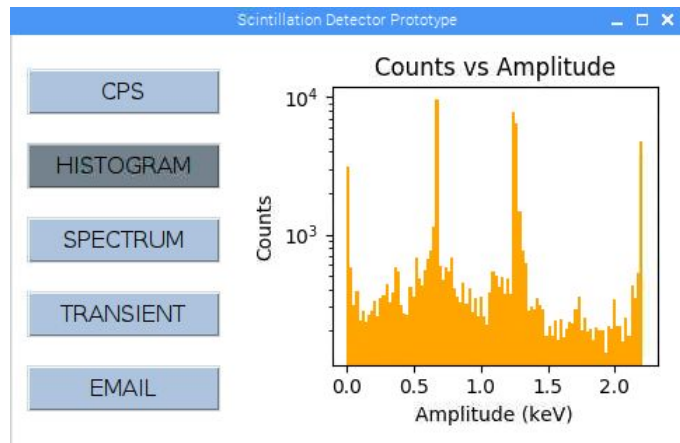

Fig. 1 User Interface displaying a histogram of the counts versus the energies. The values displayed are from an input of varying the resistance with the same current through a potentiometer.

(Haley Welch) The research for this part of the project involved understanding how to determine the three main things that were asked for: the amount of measured photons per second, the histogram graph of the counts vs the energies, and the spectrum of energies. These all needed to be found based on calibrated values. To calculate the measured photons per second, the amount of times each energy was measured was compared, and the amount of times each energy with an unusually large amount of counts was all summed together and divided by the total recording time to find the number of measured photons per second. The histogram graph of the counts vs the energies was created by counting how many times each energy was measured and displaying it as a bar graph. The spectrum of energies was determined by comparing the amount of times each energy was measured. The energies with an unusually large amount of counts were included in the spectrum of energies. To calibrate this device, the known values for the energies were used. Because the intensity of the light produced by the scintillator was proportional to the energy emitted by the radiation source, there was a linear equation relating the two. This could be found by comparing the histogram graph of the counts vs the energies with the known values for the energies. The peaks on the histogram graph were the energies that were counted the most and were therefore the most present energies. These energies corresponded to the known energy values of the radiation source. For example, there was a source with known energies x_1 and x_2 and measured peak energies y_1 and y_2 . Assume $x_1 < x_2$ and $y_1 < y_2$. This means that x_1 corresponded to y_1 , and x_2 corresponded to y_2 . The proportionality constant, k , had the following equation: $k = x_1/y_1 = x_2/y_2$. Therefore, to determine any correct calibrated energy value, multiply the measured energy by k .

III. ASSEMBLY AND TESTING (ALL)

This section will describe issues, design changes, assembly, and preliminary testing for our project. Similar to past sections, it will be separated by author and their part of the design.

(Stephen Ivanusic) The scintillator crystals discussed in section II.B “Research” were purchased and tested using the PMT tube and oscilloscope. At first, only two scintillators were purchased, the plastic and LYSO crystal. The LYSO crystal was found to have background radiation caused by the Cerium in the crystal. This would require the group to construct a filter to remove this inherent radiation from the spectrum so that other spectrums could be analyzed more accurately. This was found to be too large of a design change, so the LYSO was disregarded. However, this crystal provided the best resolution and light production of any scintillator tested, so given a longer design time and budget, it is feasible to use this crystal to create a much high resolution device capable of detecting weaker radiation sources. The plastic scintillator functioned well. However, its energy resolution was weak. It was so weak that the gain could not be turned up high enough on the device to accurately record peak amplitudes consistently. The plastic crystal, however, functioned perfectly well as a pulse counter similar to a geiger counter. This could be used for cheaper and lower resolution devices. Finally, the third option, which was researched, was the NaI(Tl) crystal. This crystal will corrode quickly when exposed to water in the air. They were often expensive and required special shipping. However, Dr. Eric Benton was able to loan us this crystal to use. Given that this type of crystal is most commonly used for scintillator detectors, we found that its energy resolution was much better than the plastic yet had no inherent radiation like the LYSO crystal. The NaI(Tl) was easily implemented into the design and used throughout the final testing.

(Stephen Ivanusic) The power supply portion of this project went fairly smoothly. Each part performed as expected with minimal issues. The electronics were attached to a small protoboard for all inputs and outputs, and high voltage wires were separated by approximately one centimeter to avoid coupling or accidental discharge. The +5V DC input was converted to -5V DC, +12V DC, and variable 150V-1500V DC. The variable DC power was used to power the photo multiplier, and changing the DC voltage could allow us to change the gain in the device. A picture of this will be attached in the appendix.

(Conor Henry) The Hamamatsu PMT R6095 that was found was purchased. This PMT came with a socket that would fit the PMT. The socket had a voltage divider and pre-amplifier already in it. However, the spec sheet given with the PMT did not provide the pinout for the socket. A huge hurdle found was trying to get the information from the seller.

After enough time had passed, steps were taken to take apart one of the three sockets that was available. In taking the socket apart, it was reverse engineered so that we could get the correct pinout, high voltage, signal, +/-5v, and ground. After finding the correct pinout of the socket connected to the PMT, the socket's voltage had to be checked pin by pin in order to know if the PMT was getting the correct voltage per pin. After the voltages per pin were correct, the PMT could safely be connected to the socket with the correct housing and scintillator in order to start reading pulses.

(Conor Henry) The housing for the PMT and scintillator and the housing for the electronics went smoothly. The PVC pipe housing that would fit the scintillator worked as planned for the plastic scintillator and could screw onto the PMT metal casing. Once it was discovered that the plastic scintillator was not the best option, new housing to cover the cathode and hold the scintillator had to be made. The NaI(Tl) crystal that was decided on had to be light and air tight. In order to compensate for these requirements, electrical tape was used to secure the crystal to the cathode while also keeping everything light tight. To ensure that the NaI(Tl) crystal and the cathode were air tight, optical grease was used. This optical grease would eliminate any air pockets and make sure that the case that held the crystal and the cathode were glass to glass. The housing for the electronics went smooth. The hole for the display was cut using the milling machine with the help of Dr. Krasinski. The hole for the usb powering of all the electronics and the hole for the buttons to switch the display was cut out using a drill with no issues. All the electronics fit perfectly in the case.

(Anh Than) Before calibration could occur, it was discovered that an MCA needed to be used instead of a Raspberry Pi. The original understanding that the MCP3008 with a sampling rate of two hundred thousand samples per second would be able to extrapolate the data was incorrect. The widths of the pulses from the PMT were in the nanosecond range and were not symmetrical. The rising edge occurred quickly, and the MCP3008 was reading the lower parts of the pulse. The sampling rate on the datasheet claimed two hundred thousand, but realistically, it was less than ten percent of that. There was an effort to optimize the code to increase the sampling rate. Computations were done outside of the sampling period so there were no software interrupts. Threading in python was used to allow multiple processes to run in parallel so that the Pi could read in the signal from multiple channels at once. None of these methods significantly increased the sampling rate or made analyzing the pulse heights easier. It was not possible to achieve the datasheet sampling rate of the MCP3008 with the Pi. This was the reason for the switch from the MCP3008 to the MCA.

(Haley Welch) The MCA used is the only one available that can be bought within the project's three hundred dollar budget, as all of the others cost thousands of dollars. With this decreased cost comes a decrease in accuracy and a decrease in functionality. The MCA used for this project was borrowed

from Dr. Benton. It is the RH Electronics DIY PIC18 MCA Kit for Gamma Spectroscopy. It is able to hold the peak of the signal until it can be read. It has one thousand twenty-four channels, and each channel has a certain energy directed to it. The channel then counts how many times the amplitude for that channel was read and graphs the counts vs the energies. The MCA is unable to be programmed, so there was not much flexibility in the appearance of the display. It does have some options that can be changed. The most useful option that can be changed is the amount of time that the data is recorded over, which can be changed in one hundred second increments from one hundred seconds to three thousand six hundred seconds. The initial graphs produced looked roughly like what would be expected in a typical spectroscopy graph. Without any radiation placed against the scintillator, the graph produced showed a wide peak with a small amplitude and a low number of counts per second, which was attributed to noise. When a radiation source was placed next to the scintillator, immediate changes were seen, and different changes were seen for different radiation sources. These changes included a higher number of counts per second and peaks that were thinner and had a higher amplitude than the noise peak.

IV. FINAL RESULTS

This section will discuss the final results of each individual part of the project. A final block diagram will be available in the appendix.

(Anh Than) The known energy graphs of the gamma radiation sources were compared with the graphs that were generated from the MCA. This was a way to analyze the accuracy of the output from the MCA.

(Anh Than) With no radiation source, the MCA detects some noise as shown in "Fig. 2". The count of detected photons per seconds is relatively low. "Fig. 3" and "Fig. 4" show the graphs of the output from the MCA and the known Cesium-137 energies, respectively. The 662 keV and 32 keV peaks from "Fig. 4" correspond with the two peaks detected in "Fig. 3" For Sodium-22, the peak around 500keV can be shown from the graph in "Fig. 5". The MCA generated spectroscopy graph in "Fig. 7" has three energy levels for Barium-133, which matches the known energy levels from "Fig. 8". The graph for the known spectroscopy is spaced out while the experimental graph is closer in distance. This is due to the MCA automatically scaling the x-axis. Lastly, for Cadmium-109, the graphs in "Fig. 9" and "Fig. 10" are extremely similar.

(Haley Welch) Shown below are images taken of the MCA generated spectroscopy graphs with different radiation sources placed next to the scintillator compared to known spectroscopy graphs for those same radiation sources.

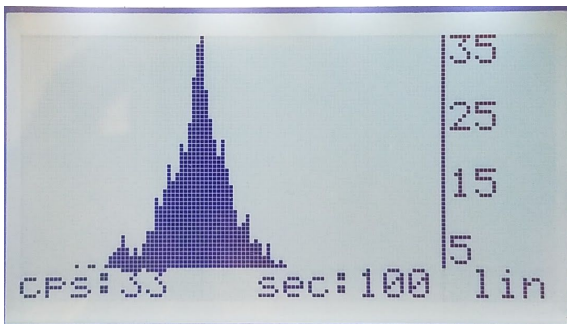

Fig. 2. No radiation source

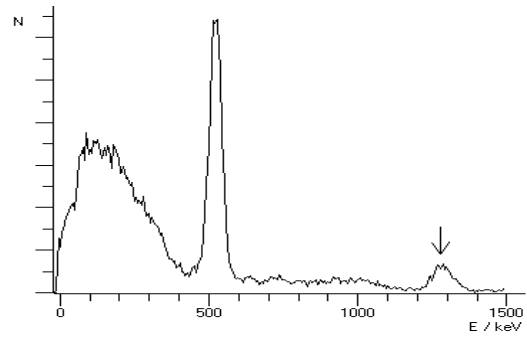

Fig. 6. Known spectroscopy graph of Sodium-22 [2]

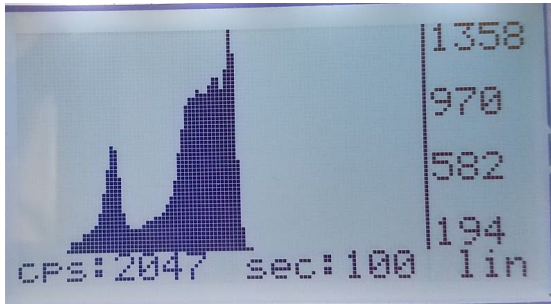

Fig. 3. MCA generated spectroscopy graph with Cesium-137

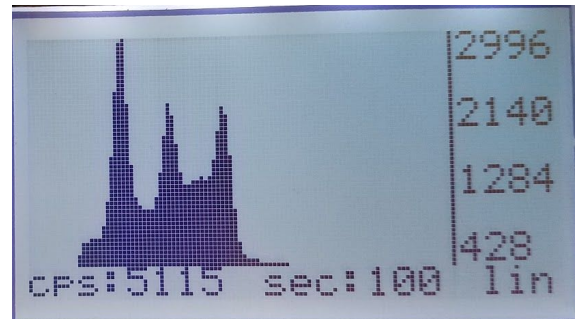

Fig. 7. MCA generated spectroscopy graph with Barium-133

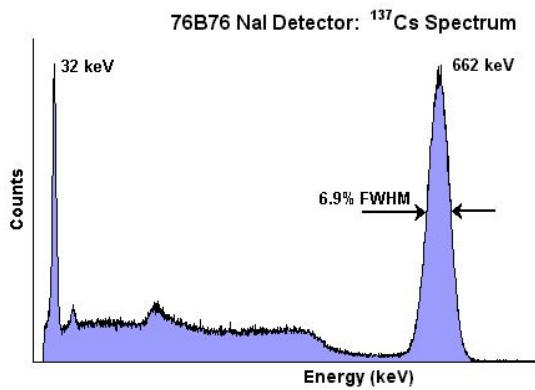

Fig. 4. Known spectroscopy graph of Cesium-137 [1]

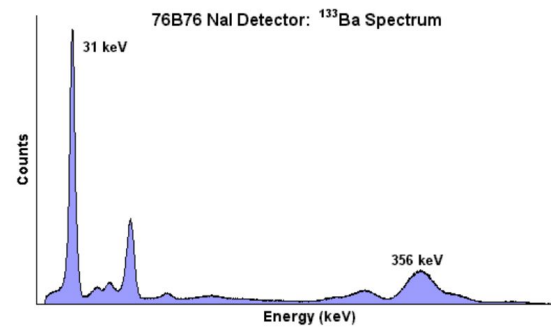

Fig. 8. Known spectroscopy graph of Barium-133 [1]

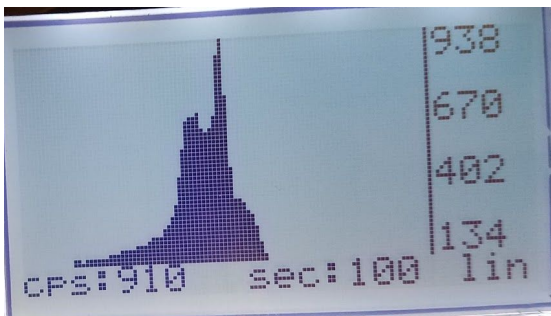

Fig. 5. MCA generated spectroscopy graph with Sodium-22

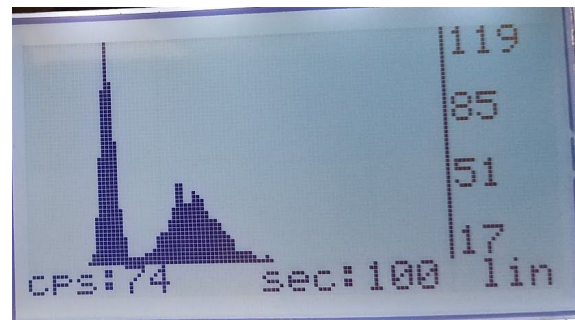

Fig. 9. MCA generated spectroscopy graph with Cadmium-109

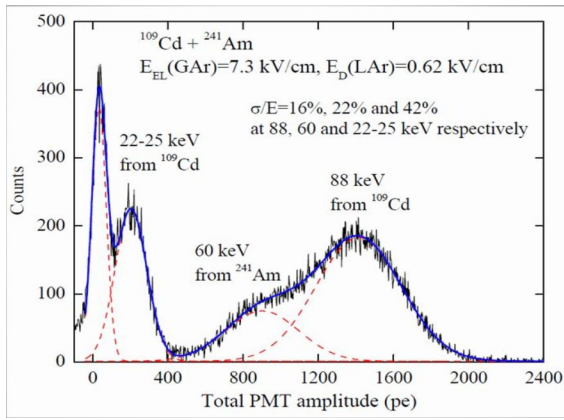

Fig. 10. Known spectroscopy graph of Cadmium-109 [3]

V. CONCLUSION (STEPHEN IVANUSIC)

The goal of this project was to create a scintillation radiation detector that is suitable for gamma spectroscopy. The benefits of this project versus others is that this can be constructed for much less than other commercial scintillators. Its best use would be in hobbyist or educational situations. There were major unforeseen issues, such as the requirement of having a multichannel analyzer discussed previously that presented issues, which could not be sufficiently solved in the time remaining for the project. Dr. Benton loaned the team many devices, which allowed us to finally complete the project sufficiently. If given the opportunity to complete this project again, an MCA could be constructed which would allow for greater control, resolution, and usability for the project to meet full specifications.

Even with these issues, the authors created a cost effective detector, which could be further improved with more time to tune and control the circuit.

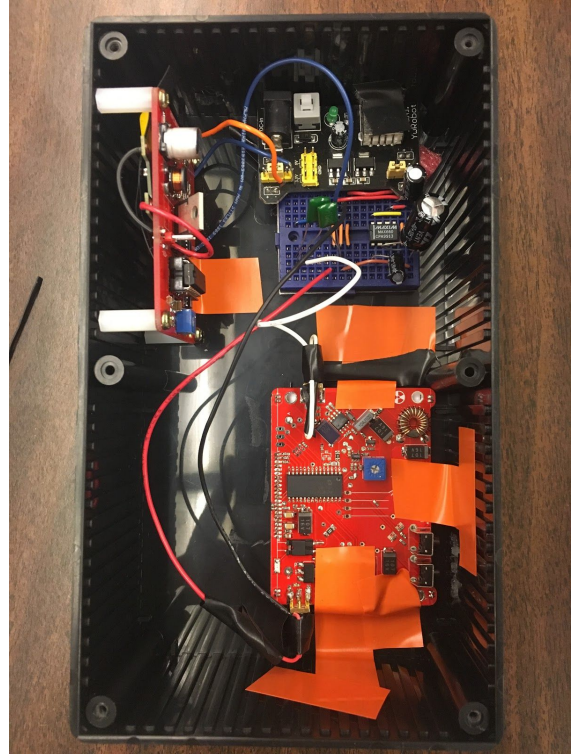

Fig. 11. Inside of Project Box

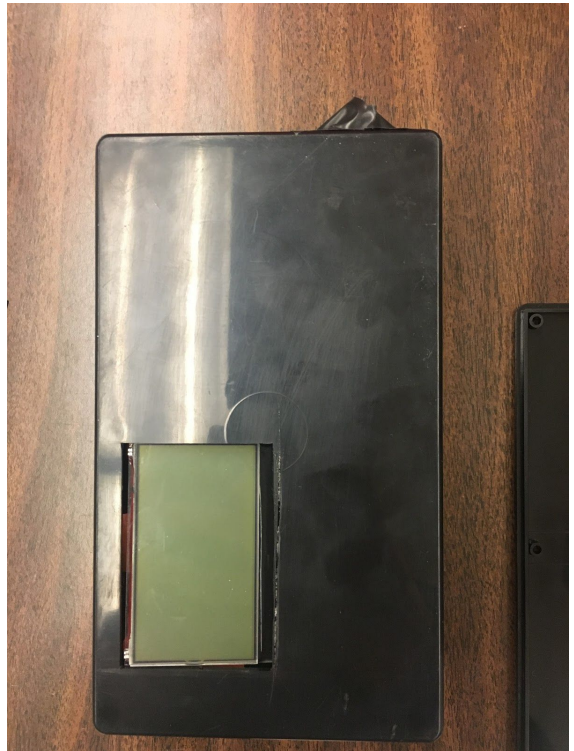

Fig. 12. Outside of Project Box

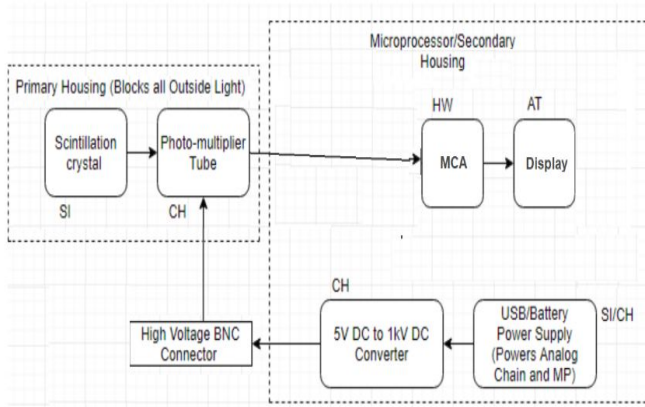

Fig. 13. Block Diagram of Project

VI. ACKNOWLEDGMENT (HALEY WELCH)

Thank you Dr. Krasinski, Dr. Ekin, and Dr. Benton for each of their contributions to this project.

REFERENCES

- [1] "GAMMA-RAD5 Gamma Ray Detection System." *Go to Amptek - X-Ray Detectors and Electronics.*, amptek.com/products/gamma-rad5-gamma-ray-detection-system/#7.
- [2] "Sodium-22." *Sodium-22*, www.ld-didactic.de/software/524221en/Content/Appendix/Na22.htm.
- [3] Sokolov, Andrey. "Two-Phase Cryogenic Avalanche Detector." *SlidePlayer*, 15 Oct. 2015, images.slideplayer.com/36/10635953/slides/slide_20.jpg.