

THE UNIVERSITY OF OKLAHOMA

GRADUATE COLLEGE

FOAM LIFT EFFICIENCY FOR GAS WELL DELIQUIFICATION IN
PRESENCE OF CONDENDATES

A THESIS

SUBMITTED TO THE GRADUATE FACULTY

in partial fulfilment of the requirements for the

Degree of

MASTER OF SCIENCE IN NATURAL GAS ENGINEERING AND
MANAGEMENT

By

AMITA HARISH KOSAMBI

Norman Oklahoma

2019

FOAM LIFT EFFICIENCY FOR GAS WELL DELIQUIFICATION IN
PRESENCE OF CONDENDATES

A THESIS APPROVED FOR THE
MEWBOURNE SCHOOL OF PETROLEUM AND GEOLOGICAL
ENGINEERING

BY THE COMMITTEE CONSISTING OF

Dr. Hamidreza Karami Mirazizi, Chair

Dr. Benjamin Shiau

Dr. Sepideh Razavi

© Copyright by AMITA HARISH KOSAMBI 2019
All Rights Reserved.

ACKNOWLEDGEMENTS

I would like to express the appreciation to my committee chair Dr. Hamidreza Karami for the guidance, encouragement, and support during this entire research work. I would like to thank my committee members, Dr. Benjamin Shiau for providing his laboratory for this research work and Dr. Sepideh Razavi for discussions and guidance. I thank Dr. Brian Grady for providing his Surfactant lab for conducting the tests.

I would also mention my regards to Dr. Suresh Sharma, my adviser for Natural Gas Engineering and Management. I thank the Faculty and Staff members of Mewbourne School of Petroleum and Geological Engineering, for their every direct and indirect effort to support during my academic and research journey. Also, I would thank Gary Stowe for providing his technical expertise, assistance at the lab.

I thank my fellow lab-mates Dr. Changlong, Dr. Shoushi, and Onyekachi Ogbonnaya for the vital discussions and help in the lab. I thank my friends Vijay Vaghela, Ashutosh Sharma for providing encouragement and moral support during this master's study.

I would like to thank my family, my parents Harish Kosambi, Leela Kosambi, my brother Atul and sis-in-law Tejal Kosambi and my nephew Manavish Kosambi, for all the understanding, support and patience. The completion of this undertaking would have been impossible without them. There are so many whom I know in one or another way, and they shared their support, encouraged me to proceed and wished

for my best, thanks to all. And in addition to this, I don't want to forget to acknowledge Myself and The One Consciousness.

TABLE OF CONTENTS

ACKNOWLEDGEMENTS.....	IV
TABLE OF CONTENTS	VI
LIST OF TABLES	IX
LIST OF FIGURES	X
ABSTRACT	XV
CHAPTER 1: INTRODUCTION	1
1.1. What is liquid loading?	3
1.2. Flow Patterns in Gas Wells	3
1.3. Liquid Unloading Techniques. Why Surfactants?	6
CHAPTER 2: BACKGROUND AND LITERATURE REVIEW	8
2.1. Surfactants and Foams	8
2.1.1. <i>Surfactant Types</i>	10
2.1.2. <i>Foam</i>	13
2.1.3. <i>Critical Micelles Concentration</i>	14
2.1.4. <i>Dynamic Surface Tension and Equilibrium</i>	17
2.1.5. <i>Surface Tension measurement methods</i>	17
2.1.6. <i>Foamability and Foam Stability tests</i>	19
2.1.7. <i>Effect of Temperature</i>	19

2.2.	Foam Lift Literature Survey.....	21
CHAPTER 3: EXPERIMENTAL SETUP		25
3.1.	Experimental Fluids	25
3.2.	Static Surface Tension Measurements.....	28
3.3.	Dynamic Surface Tension Description.....	29
3.4.	Unloading Column Setup and Procedure	31
3.5.	Unloading Experimental Setup for high temperature.....	35
CHAPTER 4: READINGS, RESULT AND DATA ANALYSIS		37
4.1.	Static Surface Tension - CMC Readings.....	37
4.2.	Static Surface Tension and CMC at 50 °C.....	39
4.3.	Dynamic Surface Tension Readings.....	42
4.4.	Liquid Unloading test results	48
4.4.1.	<i>Foam Height and Liquid Unloading, No Oil.....</i>	<i>48</i>
4.4.2.	<i>Foam Height and Liquid Unloading, 10% Oil case</i>	<i>53</i>
4.4.3.	<i>Foam Height and Liquid Unloading, 25% Oil</i>	<i>57</i>
4.4.4.	<i>Foam Height and Liquid Unloading, 50% Oil</i>	<i>61</i>
4.4.5.	<i>Liquid Unloading Efficiency Summary.....</i>	<i>66</i>
4.5.	Unloaded and Remaining Liquid, Water Cut Effects.....	68
4.6.	Foam Quality.....	72

4.7.	Foam Density	75
4.8.	Foam Half-Life	78
4.9.	High Temperature Tests.....	81
4.9.1.	<i>Foam Height and Liquid Unloading, 50 °C, No Oil</i>	81
4.9.2.	<i>Foam Height and Liquid Unloading, 50 °C, 25% Oil</i>	86
4.9.3.	<i>Liquid Unloading Efficiency at Elevated Temperatures</i>	88
4.10.	General Experimental Observations	90
CHAPTER 5: CONCLUSIONS AND RECOMMENDATIONS		93
5.1.	Conclusion.....	93
5.2.	Recommendations	95
REFERENCES		97
APPENDIX.....		100
Physical and Chemical Properties of selected Surfactants and Isopar L.....		121
Abbreviations		126

LIST OF TABLES

<i>Table 4.1: CMC values of surfactants</i>	39
<i>Table 4.2: CMC values of surfactants at 50 °C</i>	41
<i>Table 4.3: Dynamic Surface Tension Parameter and Foam Characteristics for all Surfactants</i>	47
<i>Table 4.4: Unloading Efficiency Ratios for all the surfactants</i>	68

LIST OF FIGURES

Figure 1.1 Flow Regimes in vertical pipes [1].....	4
Figure 2.1. Surfactant adsorption [9]	9
Figure 2.2. Formation of a film with a double layer of surfactant [8]	9
Figure 2.3. Amphiphilic structure of Surfactant [10]	10
Figure 2.4. Types of Surfactants based on their polar groups.....	10
Figure 2.5. Structure of Micelle [8].....	15
Figure 2.6. Normal Micelles and Inverse Micelles [15]	15
Figure 3.1. Schematic for the Dynamic Contact Angle analyzer ST tests [8].....	28
Figure 3.2. Bubble Pressure Tensiometer Testing Method [8]	30
Figure 3.3. DST measurement using Bubble Pressure Tensiometer.....	30
Figure 3.6. Schematics of Liquid Unloading setup for high temperature.....	36
Figure 4.1. Static Surface Tension (mN/m) Measurements for Various Surfactants.....	38
Figure 4.2. Static Surface Tension Measurements at 50 °C for Various Surfactants	40
Figure 4.3. DST Tests for AOS.....	42
Figure 4.4. Dynamic Surface Tension Measurements for All Surfactants at CMC.....	44
Figure 4.5. Dynamic Surface Tension Regions	45
Figure 4.6. Changes in Foam Height with Time for AOS and no Oil case	49
Figure 4.7. Changes in Unloaded Liquid Height with Time for AOS, no Oil.....	49

<i>Figure 4.8. Maximum Foam Height for all Surfactants, no Oil</i>	<i>50</i>
<i>Figure 4.9. Unloaded Liquid Volumes for all Surfactants for No Oil case</i>	<i>51</i>
<i>Figure 4.10. Remaining Liquid Volumes for all Surfactants for no Oil.....</i>	<i>52</i>
<i>Figure 4.11. Remaining Liquid Volumes for all Surfactants for No Oil case.....</i>	<i>53</i>
<i>Figure 4.12. Changes in Unloaded Liquid Height with Time for AOS and 10% Oil</i>	<i>54</i>
<i>Figure 4.13. Maximum Foam Height for all Surfactants for 10% Oil case</i>	<i>55</i>
<i>Figure 4.14. Unloaded Liquid Volumes for Different Surfactants with 10% Oil case</i>	<i>56</i>
<i>Figure 4.15. Remaining Liquid Volumes for All Surfactants with 10% Oil case</i>	<i>56</i>
<i>Figure 4.16. Changes in Foam Height with Time for AOS, 25% Oil case.....</i>	<i>57</i>
<i>Figure 4.17. Changes in Unloaded Liquid Height with Time for AOS for 25% Oil case</i>	<i>58</i>
<i>Figure 4.19. Unloaded Liquid Volumes for All Surfactants with 25% Oil Fraction</i>	<i>60</i>
<i>Figure 4.20. Remaining Liquid Volumes for All Surfactants with 25% Oil Fraction</i>	<i>60</i>
<i>Figure 4.21. Presence of emulsion layer at water oil interface, remaining liquid.....</i>	<i>61</i>
<i>Figure 4.22. Changes in Foam Height with Time for AOS, 50% Oil case.....</i>	<i>62</i>
<i>Figure 4.23. Changes in Unloaded Liquid Height for AOS, 50% Oil case</i>	<i>62</i>
<i>Figure 4.24. Maximum Foam Height for all Surfactants for 50% Oil case</i>	<i>63</i>
<i>Figure 4.25. Unloaded Liquid, Oil- water interface, 50% Oil case.....</i>	<i>63</i>
<i>Figure 4.26. Unloaded Liquid Volumes for All Surfactants with 50% Oil Fraction</i>	<i>64</i>
<i>Figure 4.27. Remaining Liquid Volumes for All Surfactants with 50% Oil Fraction</i>	<i>65</i>

<i>Figure 4.28. Unloaded and Remaining Liquid Volumes for AOS, 50% Oil case.....</i>	<i>66</i>
<i>Figure 4.29. Liquid Unloaded for AOS, all water-oil fractions</i>	<i>68</i>
<i>Figure 4.30. Improved Liquid Unloading for CTAB with cosolvent.....</i>	<i>69</i>
<i>Figure 4.31. Percentage Reduction for AOS.....</i>	<i>70</i>
<i>Figure 4.32. Percentage Reduction for all surfactants for 10% oil case.....</i>	<i>71</i>
<i>Figure 4.33. Percentage Reduction for all surfactants for 25% oil case.....</i>	<i>71</i>
<i>Figure 4.34. Percentage Reduction for all surfactants for 50% oil case.....</i>	<i>72</i>
<i>Figure 4.35. Foam Quality for all the surfactants, for No Oil case.....</i>	<i>73</i>
<i>Figure 4.36. Foam Quality for all the surfactants, for 10% Oil case</i>	<i>73</i>
<i>Figure 4.37. Foam Quality for all the surfactants, for 25% Oil case</i>	<i>74</i>
<i>Figure 4.38. Foam Quality for all the surfactants, for 50% Oil case</i>	<i>74</i>
<i>Figure 4.39. Foam Density for all surfactants for no Oil case</i>	<i>76</i>
<i>Figure 4.40. Foam Density for all surfactants for 10% Oil case.....</i>	<i>76</i>
<i>Figure 4.41. Foam Density for all surfactants for 25% Oil case.....</i>	<i>76</i>
<i>Figure 4.42. Foam Density for all surfactants for 50% Oil case.....</i>	<i>77</i>
<i>Figure 4.43. Foam half-life for all the surfactants for No Oil case</i>	<i>78</i>
<i>Figure 4.44. Foam half-life for all the surfactants for 10% Oil case</i>	<i>79</i>
<i>Figure 4.45. Foam half-life for all the surfactants for 25% Oil case</i>	<i>79</i>
<i>Figure 4.46. Foam half-life for all the surfactants for 50% Oil case</i>	<i>79</i>

Figure 4.47. Foam half-life comparison for CTAB with cosolvent and without cosolvent	81
Figure 4.48. Comparison Foam Height, AOS for 100% water case, at two temperatures	82
Figure 4.49. Comparison Liquid Height, AOS for 100% water case, at two temperatures ...	82
Figure 4.50. Foam and Unloaded Liquid Height, 50 °C, CTAB(C) and CTAB(NC), No Oil	83
Figure 4.51. Comparison of maximum foam height at RT and 50 °C, no oil	84
Figure 4.52. Comparison of Foam Half-Life at RT and 50 °C at 100% water	84
Figure 4.53. Comparison of Foam Quality at RT and 50 °C at 100% water	85
Figure 4.54. Comparison of Foam Density at RT and 50 °C at 100% water	86
Figure 4.55. Comparison Foam Height, AOS for 25% Oil case, at two temperatures	86
Figure 4.56. Comparison Liquid Height, AOS for 25% Oil case, at two temperatures	87
Figure 4.57. Comparison of max foam height at RT and 50 °C at 25% Oil case.....	87
Figure 4.58. Comparison of foam half-life at RT and 50 °C at 25% Oil case	88
Figure 4.61. Unloaded liquid comparison- No oil case - at Room Temperature and 50 °C ...	89
Figure 4.62. Unloaded liquid volume comparison - 25% oil- Room Temperature and 50 °C	89
Figure A.1. Dynamic Surface Tension Plots for various Surfactants.....	101
Figure A.2. Changes in Foam and Liquid Height for Surfactant, No Oil case.....	103
Figure A.3. Changes in Liquid Height with Time for Surfactants, for 10% Oil case.....	105
Figure A.4. Changes in Liquid Height with Time for Surfactants, for 25% Oil	106
Figure A.5. Changes in Foam Height for Surfactants for 50% Oil	108

<i>Figure A.6. Liquid Unloaded and Remaining for various Surfactants, all water-oil fractions</i>	109
<i>Figure A.7. Percentage Reduction for all surfactants</i>	110
<i>Figure A.8. Comparison at 50 °C, Foam and Liquid Height, 100% water case</i>	112
<i>Figure A.9. Comparison at 50 °C, Foam and Liquid Height, 25% oil case</i>	113
<i>Figure A.10. Unloaded and Remaining Liquid volume for Surfactant at 50 °C</i>	116
<i>Figure A.11 Solutions prepared for AOS, Commercial Surfactant 1 and 2 above CMC</i>	116
<i>Figure A.12 AOS foam for 100% water case and 10% oil case</i>	116
<i>Figure A.13 AOS foam for 100% water case, at the end of 60 min of unloading test</i>	117
<i>Figure A.14 Unloaded, remaining liquid, AOS below CMC, Makon above CMC, 25% oil</i>	117
<i>Figure A.15 Commercial surfactant 1, 2 and Makon, Unloaded and Remaining Liquid above CMC, 50% oil case</i>	118
<i>Figure A.16 Production column, Amphosol, Commercial Surfactant- above CMC, 50% oil</i>	118
<i>Figure A.17 Limited solubility of CTAB in water and precipitation</i>	118
<i>Figure A.18 CTAB mixture with isopropanol and water</i>	119
<i>Figure A.19 Gel formation and solubility issues of Biosoft in water</i>	119
<i>Figure A.20 Oil and water deposition on inner surfaces, counted in losses</i>	119
<i>Figure A.21 Foam decay for 50% oil case, Oil-water interface and embedded foam in the oil</i>	120

ABSTRACT

Liquid loading or inability of gas to carry the accumulated liquids along the wellbore shortens the life of Natural Gas wells, costing the operators in revenue. The hydrocarbon condensates and/or water are usually seen produced along with the production of Natural Gas. Over time as the formation pressure is declined, the gas velocity is seen reduced, which causes accumulation of liquids at the bottom hole and results in reduced production. One of the common gas-well deliquification techniques is surfactant injection or assisted foam lift. The injected surfactant creates foam due to agitation between liquids and the flowing gas. This method is proven very beneficial especially at low-pressure gas reserves, where the required critical gas velocity to avoid liquid loading gets reduced to around 20% of its original value. However, it is known that the presence of condensed hydrocarbons lowers the surfactant's efficiency in foam lift operations. Gas wells operating at higher water cut are good candidates for foam lift as the presence of water enhances the foaming and helps the unloading. Condensates present in the liquids do not foam well with conventional surfactants, limiting the foam lift to the cases compared with only water as the loaded liquid. This study is intended to experimentally evaluate the performances of various surfactant types in the presence of both water and hydrocarbon condensates with regards to unloading the liquids.

The purpose of this study is to relate the fundamentals of surfactant characterization with foam lift efficiency. Six different types of surfactants Anionic, Cationic, Non-ionic (Two), Amphoteric and two commercial surfactants are selected for the study in the

ABSTRACT

batch application. Experimental work includes static (ST) and dynamic surface tension (DST) measurements and liquid column unloading tests with varying surfactants and concentrations. The liquid unloading tests are completed at the laboratory scale with changing liquid column water cuts and a fixed air injection rate to generate foam. The results are recorded in terms of unloaded liquid, foam quality, liquid drainage rate, and foam half-life. A noticeable drop is observed in liquid unloading as the water cut is reduced, showing the diminishing foam lift efficiency. However, the significance of this drop is different for different surfactant types.

In addition to testing these surfactant's performance at room temperature which is in the range of 20-25 °C, the effect of elevated temperature is studied with respect to deliquification for the selected range of concentration and selected water cuts. The deliquification tests conducted in an insulated set up in a temperature range of 40-55°C. The unloaded liquid is seen reduced at the elevated temperature.

CHAPTER 1: INTRODUCTION

Over the life of gas production wells, as the reservoir depletes, they face the issue of liquid loading. Gas wells commonly produce water and hydrocarbon condensates along with the gas, and rarely produce only gas. Wet gas wells have gas at the reservoir conditions, but as the pressure decreases below dew point pressure, at some point along with the production system and heavier hydrocarbons condense out. This can happen in the formation or at some point in the tubing, depending on the fluid composition. This causes a two-phase gas-condensate flow. In addition, water can be present from various sources, such as water coning, presence of aquifer in the gas reservoir, or free formation water [1]. The condensate-water cut varies from well to well, and changes over the production lifetime of a well.

Over a well's lifetime and due to the reduced reservoir pressure, the gas velocity becomes insufficient to carry the liquids to the surface. As a result, the liquid holdup in the well increases and eventually the well bottom-hole gets loaded with liquids. Once this happens, along with the reduced gas production, operators lose the hydrocarbon condensates as well, which are considered a valuable source of energy due to their higher calorific value. If not addressed in time, eventually the well might die. Operators need to look at various techniques to resolve this issue and unload the liquids from the gas wells. These techniques are commonly called well deliquification methods.

The recent outlook of low oil and gas prices encourages operators to produce from existing mature reservoirs instead of exploring new reserves. This means the innovative technologies are needed to artificially lift and improve the production of existing declined gas reserves. Foam lift is one of the verified gas well deliquification techniques for natural gas wells. Foam reduces the surface tension of the liquid, and hence the minimum critical velocity of the gas required to carry the gas reduces. Reduced liquid surface tension helps to shift the flow regime to an annular-mist flow regime [2]. The foam helps to reduce the density of the liquid and hence the hydrostatic pressure of the column bottom. Foam is able to flow as a continuous body at lower gas velocity and prevents the fallback of liquid [2] [3]. This helps to increase the life of the gas well. In this method, a surfactant is injected downhole continuously or in batches, and the liquid is unloaded within the foam structure. The usage of surfactants is cost-efficient as it doesn't require any external energy supply. The challenging part with foam lift is to maintain the performance of the surfactants in the presence of gas condensates. Most surfactants are water soluble, and do not perform efficiently in the presence of condensates. This study aims to experimentally evaluate the performances of various surfactants in the presence of both water and condensates.

In literature, static surface tension (ST) [4] [5] and dynamic surface tension (DST) [6] [7] are considered as the determining characteristics of surfactants affecting the foamability. In this study, these characteristics are used to evaluate the surfactants' foamability in presence of light oil. The presence of oil/ condensate largely affects the

foamability as they act as defoamers and surfactants don't foam well with them. In this work, performances of five types of surfactants are studied in terms of liquid (oil + water) unloading. Static and Dynamic surface tension tests are performed to identify CMC and surface tension gradient respectively for each surfactant at different concentrations. Foam tests are then conducted to analyze their foamability in absence of oils and in the presence of oils with different fractions.

1.1. What is liquid loading?

Liquid loading can be simply described as the inability of production gas to carry the produced condensates and/ or water to the surface. These produced liquids accumulate at the bottom of the well, impose a back pressure on the formation, and restrict the production. This phenomenon is known as Liquid Loading. Gas flowing with the reduced velocity cannot lift the liquids within the wellbore. If this issue persists and is not addressed, the condition may result in fluctuations in the production and eventually stop the production completely [1]. This can leave behind the substantial amount of hydrocarbons (gas and condensates) uncaptured. To better understand liquid loading, we will need to understand two-phase flow patterns in a well.

1.2. Flow Patterns in Gas Wells

It is necessary to understand how the changes in liquid-gas flow patterns take place in production tubing, in order to get the concept of liquid loading. On a broader scale, four types of flow patterns are classified, called bubble flow, slug flow, churn (slug-

annular) flow and annular-mist flow, as shown in Figure 1.1. The flow pattern transitions are a function of the velocities of gas and liquids (condensate + water) and their mass fractions in the flowing stream [1].

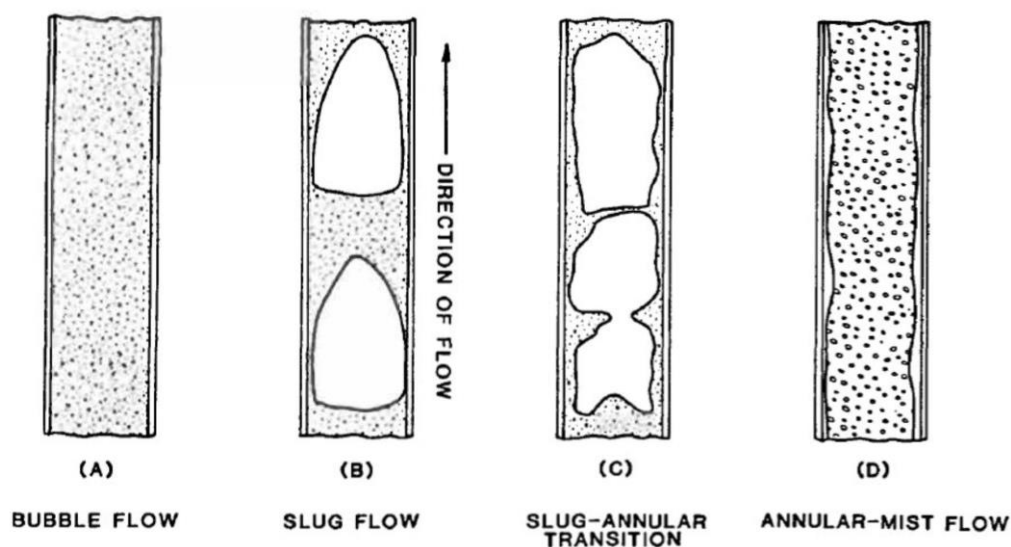

Figure 1.1 Flow Regimes in vertical pipes [1]

Bubble Flow: In this regime liquid to gas ratio and pressure gradient are maximum as compared to any other flow regimes. The production tubing is almost loaded with liquids and gas bubbles are dispersed in a continuous liquid phase. The gas is in the form of bubbles with insufficient energy to carry the liquids with them [1]. The existence of this flow regime in production tubing means well needs to be treated before it shuts off completely.

Slug Flow: In the slug flow regime the gas fraction is higher as compared to bubble flow. Gas bubbles aggregate to form bigger Taylor bubbles within the continuous liquid phase. Gas velocity is still not enough to carry the liquids upwards

continuously, which results in liquid falling down frequently [1]. Hence liquid starts accumulating at the bottom.

Churn Flow: In this regime with further increased gas velocity, a transition of the continuous liquid phase to the continuous gas phase (slug to annular) takes place. Liquid droplets and film are carried through the gas stream with oscillatory movements. Liquid and gas turbulence both contribute to the pressure drop in the tubing [1].

Annular-Mist Flow: This flow regime exists when the initial reservoir pressure is high enough, and gas is flowing with a high velocity. The liquid is divided into two parts: a liquid film around the wall continuously moving upward, and fine liquid droplets entrained and dispersed in the center gas core. Gas velocity dominates over the liquid velocity. There is very little liquid holdup and the pressure drop in the production tubing is mostly due to the frictional losses due to the high velocity of gas than the pressure drop due to liquid hold up [1].

In a gas well, initially with higher gas rates, the gas is able to carry the liquid to the surface and an annular flow pattern is seen. As the gas rate keeps dropping the flow pattern moves to churn flow, then slug flow, and then to bubble flow. As a result, the production gets affected and becomes irregular and unstable. This phenomenon is called liquid loading, created by increased hydrostatic pressure in the production tubing resulting in back pressure on the formation and further decrease in gas velocity. Apart from the interruption in production, this loaded liquid column causes

massive corrosion and material integrity issues [1]. It is necessary to restore the flow back to an annular flow pattern to avoid unstable production and eventual well shut off.

1.3. Liquid Unloading Techniques. Why Surfactants?

Many techniques are available for unloading the liquids from a gas well, such as velocity strings, plunger lift, surface compressor, foam lift, continuous or intermittent gas lift, and sometimes a combination of two or more techniques like gas lift and plunger lift. Disadvantages are associated with each one of these techniques depending on the operating conditions. Plunger lift is an efficient and cheap technique, but it results in intermittent production and causes some loss of gas. Velocity strings cause loss of production as they reduce the flow area. Providing a surface compressor helps to increase the inflow drawdown, but it comes with large increases in capital and operating cost. Gas Lift has a higher cost and requires a minimum well bottom-hole pressure to stay efficient.

In contrast, Surfactants are very cost-effective. The gas wells that produce water along with gas are good candidates for foam lift as water provides a supportive medium to generate foam. In favorable conditions, foam lift can result in significant delays in liquid loading and reduction of critical gas velocity to less than half of its original value. This means a cheap and efficient way of well deliquification. However, the efficiency of surfactants gets negatively affected by the presence of condensates, as the foam generation gets deteriorated. This study is an effort to evaluate the performance

CHAPTER 1

of different surfactant types in well deliquification in presence of varying fractions of condensates.

CHAPTER 2: BACKGROUND AND LITERATURE REVIEW

Pure water does not foam. The presence of foam in the water means some kind of impurity or surface-active substance has been introduced to the pure water and surface properties of water have changed. By the addition of an external substance that gets adsorbed at the water-air interface, surface properties of water such as surface tension change. Water has high surface tension due to intermolecular forces between the water molecules. Water possesses hydrogen bonds with high energy.

In terms of energy, the work required to increase the surface area of a liquid is called surface tension. The molecules of liquid tend to be in the bulk, where intermolecular forces are evenly distributed. At the interface, there is a tension as intermolecular forces are stretching the molecules to maintain the phase. The work per unit wetted length on the surface is defined as surface tension. It is denoted with symbol γ and with the SI unit of mN/m. In the case of solids “surface free energy” and in the case of two liquids or liquid and solid “interfacial tension” terms are used [8].

2.1. Surfactants and Foams

Surfactants are surface-active substances that reduce the surface tension of liquids or the interfacial tension of two-phase systems due to adsorption at the surface or interface respectively [8]. Figure 2.1 shows the adsorption structure of surfactant molecules in air-water and oil-water systems. Figure 2.2 shows the adsorption of surfactant molecules within the bubble film with double-layered surfactants. The

surfactant tails are stretched out towards the gas while the heads stay inside the liquid film.

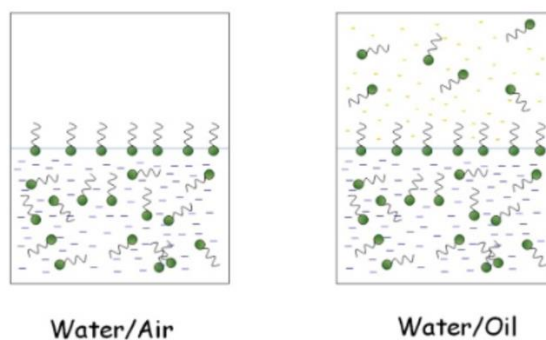

Figure 2.1. Surfactant adsorption [9]

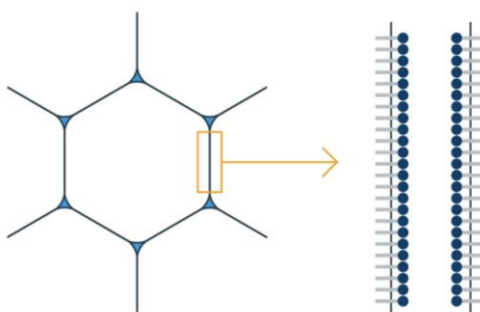

Figure 2.2. Formation of a film with a double layer of surfactant [8]

The molecular structure of surfactants is amphiphilic, which means they have water and oil-loving functional groups called hydrophilic and hydrophobic groups, respectively. They are named in terms of “hydro” because in most cases solutions are prepared in water. Hydrophobic groups can be termed as Lipophilic (Lipid or oil-loving). The hydrophilic group (polar end) has good compatibility with water while the hydrophobic group (nonpolar end) has good compatibility with oils [10]. (Refer to Figure 2.3)

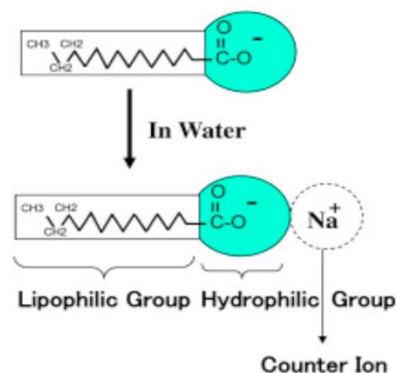

Figure 2.3. Amphiphilic structure of Surfactant [10]

2.1.1. Surfactant Types

Surfactants are categorized into two broader groups as ionic (dissociating into charged ions at their polar end when added to water) and non-ionic (not dissociating when added to water). The Ionic surfactants are further divided into anionic, cationic and amphoteric, based on the type of charge they possess at their head [10], as summarized in Figure 2.4

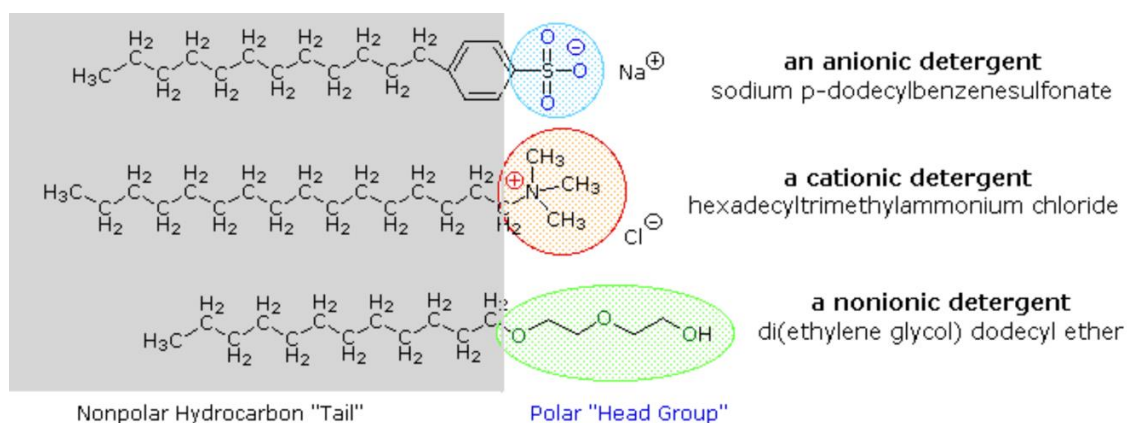

Figure 2.4. Types of Surfactants based on their polar groups

Anionic Surfactants: When added to water they dissociate into a negatively charged amphiphilic organic ion and a positively charged inorganic cations. The negatively charged anion is bigger in size compared to the positively charged cation. This anion is efficient in attracting dirt, soil particles which are generally negatively charged [11]. In general, Anionic surfactants are nontoxic and foam better compared to other types of surfactants. They are generally stable at ambient temperatures up to 200 °F. Some sulfonate surfactants are good at higher temperature ranges [3]. The manufacturing cost of anionic surfactants is low. They are very common for oilfield applications as they are quite chemically stable, and available on a commercial scale.

Some common examples of hydrophilic groups of anionic surfactants are Sulfates, Sulfonates, Phosphates, Carboxyl, etc. The examples of anionic surfactants are Sodium Lauryl Sulphate (SLS), Sodium Dodecyl Sulfate (SDS), Potassium laurate, Alkyl sulfates.

Cationic Surfactants: When added to water they dissociate into a positively charged amphiphilic organic ion, which is relatively bigger in size, and into a smaller negatively charged halide anion [11]. They foam moderately well, have good temperature stability, and are considered good for gas wells producing low condensates [3]. Manufacturing of Cationic surfactants is more expensive than Anionic surfactants, they get adsorbed at the surfaces hence not commonly used [11]. They are more toxic than anionic ones and they also have solubility issues in water.

Some common examples of hydrophilic groups of cationic surfactants are quaternary amines.

Amphoteric Surfactants: Depending on the pH of the amphoteric surfactant solution in water, they may perform like anionic or cationic ones [11]. They have both the ions at the hydrophilic head and can dissociate either like anionic or cationic. They are generally eco-friendly, non-toxic, and have a high manufacturing cost. They foam well (lower than anionic) and sometimes possess antibacterial properties. They have good stability at high temperatures and in the presence of salts. They are good for gas wells which produce condensates in the range of low to medium [3]. Some common examples of hydrophilic groups of amphoteric surfactants are carboxybetaine, sulfobetaine.

Non-ionic Surfactants: When added to water they do not dissociate into any charged ions [11]. They can form good mixtures to boost the properties of other ionic surfactants (foam boosters). Their solubility gets affected in the presence of salts and at higher temperatures. They have average foaming properties with water. They show good foam if are used below cloud point temperature but foamability gets affected above cloud point temperature. The cloud point temperature of the surfactant is the temperature at which the solution starts to show phase separation and becomes cloudy. Due to phase separation surfactant's concentration decreases and the performance as well [12]. It is necessary to look at the cloud point of nonionic surfactant while selecting. Mixtures of anionic and non-ionic are commonly used and

can stay efficient with high salinity. Some examples of non-ionic surfactants are esters, ethoxylate, alcohol, alkoxyates.

The categorization of surfactants can also be done based on their solubility in solvents. This information can be useful if the application of the surfactant is in water or in oil. Hydrophilic surfactants have good solubility in water, while hydrophobic surfactants are soluble in oils. The terms hydrophilic and hydrophobic are based on their hydrophilic-lipophilic balance (HLB). Anionic, cationic and amphoteric surfactants are generally hydrophilic, but non-ionic surfactants can be hydrophilic or lipophilic depending on their HLB. Hence, they can be soluble in both solvents (water or oil) [10].

2.1.2. *Foam*

Foam is a substance consisting of a dispersed gas phase within the continuous liquid phase. Foam is generated by introducing surfactants to water and an agitation method like simply shaking, stirring or sparging gas through the surfactant solution. The foam quantity, foam type, and bubble size depend on the agitation method, concentration of surfactants, and type of liquid and gas involved. Foam formation is an adsorption phenomenon in which surfactant molecules get adsorbed at the gas-liquid interface, which reduces water surface tension. Adsorption makes the interface more elastic and with less energy compared to pure water.

Two essential properties of surfactants are foamability and foam stability. Foamability shows how quickly and in how much quantity the foam is generated. It largely

depends on surface tension, critical micelle concentration (CMC), and the method used for foam generation. Foam stability is a function of the molecular structure of surfactant, packing of surfactant molecules at the interface, liquid phase composition and other properties like temperature, the pressure of the involved system [13]. The foam decay or liquid drainage is not a well-understood phenomenon. Drainage is influenced by gravity i.e. presence of a liquid mass in the foam and the capillary forces. The balance of these forces decides foam stability [14] [6].

Hydrophobic part of surfactant, staying out of water at the air-water interface, doesn't support foam stability, while the hydrophilic part helps to enhance the stability.

2.1.3. Critical Micelles Concentration

A solution's surface tension decreases as the concentration of surfactant in solution increases. This decrease takes place down to a certain minimum ST value, where it reaches a plateau. Further increase in concentration beyond this point results in no change in ST [12] [8]. This concentration of surfactant at which minimum ST is achieved is the Critical Micelles Concentration (CMC). At CMC, the surfactant molecules start forming micelles in the bulk and the air-water interface gets saturated with them. The formation of the micelles is a special tendency of surfactant molecules to get assembled by themselves in the solution. When there is no more decrease in surface tension, it is known as equilibrium surface tension. The structure of the micelles is shown in Figure 2.5.

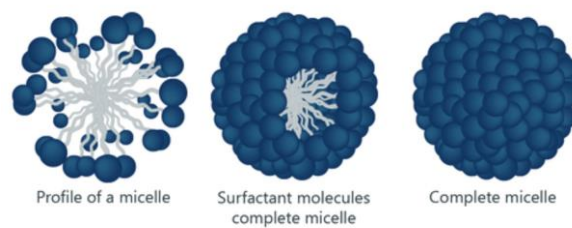

Figure 2.5. Structure of Micelle [8]

The structure of micelles and reverse micelles largely depends on the liquid phases involved in the system. Normal micelles are seen when the surfactants are dissolved in water (polar) solvent or with oil (nonpolar) present in water (polar solvent). As shown in Figure 2.6, the polar heads are directed towards the water outside and tails are towards the oil droplets inside. Reverse micelles are seen in organic solvents (oil) or also in case of water present in the organic solvent. The tails are directed towards the oil outside and the polar heads are directed towards the water droplets inside the oil. Figure 2.6 shows the normal and reverse micelles structure.

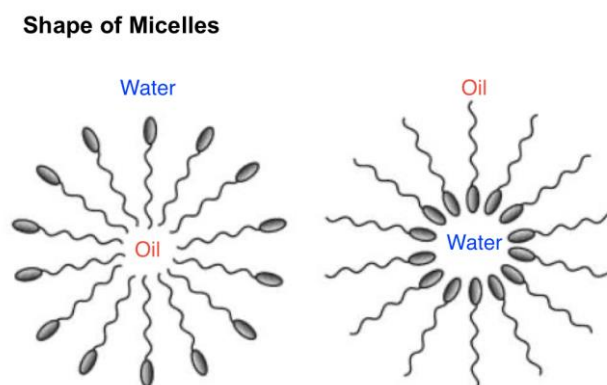

Figure 2.6. Normal Micelles and Inverse Micelles [15]

The CMC of a surfactant is a good measure of its efficiency as a foaming agent; the lower the CMC, the more efficient the surfactant is. A low CMC helps to form a greater amount of foam with smaller surfactant amounts. A factor affecting the CMC is the

molecular structure of the surfactant. As the length of the hydrophobic group/ tail increases the CMC of surfactant decreases [12] due to increased hydrophobicity of the surfactant molecules at the hydrocarbon chain [16]. CMC of surfactant first decreases and then increases with an increase in temperature. The temperature effect is discussed in detail in section 2.1.7.

CMC is a function of many other factors like surfactant type, pressure, the solvent used, pH of the solvent [17]. CMC is an important characteristic for surfactants and many times used to measure the foaming capability. A surfactant having lower CMC value can produce more amount of foam than the surfactant with higher CMC compared within the same type. The stability of the foam is high if the CMC is low [16]. It is also observed for some surfactants that they are good in reducing the surface tension and have low CMC, but they don't have good foamability and foam stability [13].

Gcali (2017) in her work [4] studied surfactant performance and concentration effects. She observed an increase in foam production and liquid unloading by increasing the concentration below CMC. Beyond CMC however, she did not observe much improvement in terms of liquid unloading. Therefore, for this study, three concentrations were selected for the unloading tests, below CMC, at CMC and above CMC.

2.1.4. *Dynamic Surface Tension and Equilibrium*

As surfactants are added to water, their molecules tend to travel and get adsorbed at the air-water interface. This transportation keeps happening until the equilibrium is achieved at a fixed concentration. Surface tension is a dynamic phenomenon and its reduction with the introduction of surfactants takes place over time. Hence a time-dependent value of surface tension is measured, which is dynamic surface tension (DST). For this work, a bubble pressure tensiometer was used for DST measurements.

As the surfactant concentration is increased, the rate of change of surface tension or surface tension gradient ($d\gamma/dt$) increases. That is because the rate of travel of surfactant molecules to the interface is increased and surface tension drops faster. Also, as the temperature of the solution increases the DST gradient increases due to the increased diffusivity of surfactants [14].

2.1.5. *Surface Tension measurement methods*

Measurement of surface tension is necessary to determine the critical micelle concentration as at this concentration value the surfactant is most efficient in terms of foamability and liquid unloading. Above this critical concentration (CMC) there is no significant increase in foamability [4]. Many methods are available for static and dynamic measurements of surface tension. Some of these methods are described below [8]:

CHAPTER 2

Ring or Du Nouy method: A metal ring is placed at the surface of the liquid. The force required to pull this ring out of the liquid-air interface is used to determine the surface tension.

Rod or Du Nouy-Paddy method: This measurement is based on the required force to pull out a metal rod after immersing it in the sample liquid.

Wilhelmy Plate method: The force required to push a polished plate into the interface and to pull it out of the interface is used to calculate the surface tension. The contact angle made by the liquid sample with the solid plate is used in calculations [8]. This method is used for the current work and described in detail in Section 4.1.

Bubble pressure method: The instrument used is known as Bubble Pressure Tensiometer. It utilizes the internal pressure of a gas bubble inside the liquid sample to calculate the surface tension over the age of the bubble. The method is used in this study for determining dynamic surface tension and is explained in detail in Section 4.3.

Pendant drop method: This is used for static surface tension measurement. The shape of a liquid drop injected from a fine needle is used to determine the surface tension.

Spinning drop method: This method is used for static surface tension measurement at very low ST and interfacial tension (IFT) values. ST and IFT are determined using the angular speed of a rotating tube and the shape of the sample liquid drop.

2.1.6. *Foamability and Foam Stability tests*

The amount of foam produced, and foam stability plays an important role during foam lift deliquification [2]. Many commercial instruments are available in the market for foamability and foam stability measurement. Generally, they are based on the Ross Mile and dynamic foam production methods. Some American Society of Testing and Measurement (ASTM) standards are available for foam generation. One is ASTM D3601 (based on bottle tests), in which foam is produced by shaking the sample in a closed vessel and then foam volume measurements are done. Using ASTM D3519 (based on blender tests), foam is produced in a warring blender where aggressive agitation takes place. Using ASTM D1173 (based on Ross-Miles method), foam is produced in a foam pipet and foam receiver. The foam height is measured providing the volume of foam. Using ASTM D892 (based on dynamic method), foam is produced in a column or calibrated cylinder by allowing a measured flowrate of gas sparge through it. In this study, the Dynamic method of foam production is selected using Nitrogen gas to generate the foam. In addition to the foam production column, a foam receiver is used to measure the unloaded foam.

2.1.7. *Effect of Temperature*

Past literature [17] [18] available for the temperature effects on the CMC of the surfactants explore the phenomena at the molecular level i.e. hydration of hydrophilic (water-loving) and hydrophobic (water-hating) parts of surfactants. Depending upon temperature change and molecular structure of the surfactants these two phenomena

play their roles in altering the CMC. Hydration of hydrophilic part of the surfactant generally starts during 20-50 °C. The change in water structure or hydrogen bond is very little at this lower range of temperature increase. Initially, an increase in temperature causes a reduction in hydration of hydrophilic part which favors the micellization. And hence CMC value is reduced at the initial range of increased temperature. As the temperature keeps increasing the hydration of the hydrophobic part increases which causes distortion the water structure and breakdown the hydrogen bond of water surrounding the hydrocarbon chain. Properties of water at high temperatures vary as compared to ambient temperature, as the three-dimensional hydrogen bond structure is broken. Water loses its polarity and behaves like alcohol [19]. As temperature increases the distortion in water structure increases, the possibility of hydrogen bond formation is reduced, which delays the micellization and hence CMC is increased [17].

Therefore, with the increase in temperature, the CMC first decreases and then increases showing U- shape pattern of CMC versus temperature plot [18]. The temperature corresponding to minimum CMC is different for different surfactants. It depends on the surfactant type, structure and HLB value. It is important to know the temperature and surfactant concentration range during the application of surfactants.

The stability of surfactants at high temperatures is an important factor in foaming. In general, anionic surfactants lose their stability at high temperatures [3] and that affects the foamability and liquid unloaded. Cationic surfactants have better stability at high

temperatures. Amphoteric surfactants have good temperature stability [3]. The effect of temperature is notably seen for non-ionic surfactants. The cloud point temperature of non-ionic surfactant is needed to observe while their selection. Their solubility reduces at higher temperatures.

In this study DST tests for high temperatures are not performed. As observed in the literature [14] rate of decrease in surface tension increases with temperature as the diffusion is increased.

2.2. Foam Lift Literature Survey

One of the most comprehensive works on foam lift is completed by Ajani (2014) [5], an experimental and modeling study of the effects of surfactants on liquid loading in vertical gas wells. The surfactants investigated were five types of commercial surfactants characterized into anionic, amphoteric and cationic classes. The objective was to study the effects of surfactants in terms of liquid unloading in 2-inch and 4-inch ID, 40-ft vertical pipes at varying supercritical gas and liquid velocities. Using the experimental data for foam flow he predicted flow transition from annular to intermittent flow. His study included the effect of surfactant concentration on foam half-life and surfactant's ability in terms of liquid unloading. A model was developed based on the experimental results, predicting the pressure gradient of foam flow. The measurements were recorded for the liquid holdup, pressure gradient, foam flow regime, and the required critical superficial gas velocity of well deliquification. He also built the model to predict the pressure gradient for foam flow. In terms of liquid

unloading, the results showed the usage of surfactant significantly delayed the liquid loading in gas wells. Increasing the surfactant concentration beyond the CMC did not prove beneficial for liquid unloading. Regarding different surfactant types, the highest unloading efficiency was observed by using the anionic surfactant for air-water flow. He also took the brine solutions at 65°C temperature. Cationic and Amphoteric showed good results at high temperatures and in brine [5]. His work leaves the scope for future work to determine the foam stability in the presence of oil, which is aimed at in the current study.

Kawale (2012) [6] studied the influence of dynamic surface tension on foam application in gas well deliquification. His work includes the influence of DST on foamability in a customized setup. He used anionic (SDS), cationic (CTAB), non-ionic (Brij 30) and commercial (Trifoam Block 820) surfactants. He also tested his results in the presence of salt (NaCl). He worked on finding a correlation between DST and the foamability of surfactants. DST was compared through the Rosen parameter and linked to foamability and foam density of surfactants [6].

Later, Van Nimwegen (2015) [20] studied the hydrodynamics of air-water foam system with 2" ID pipe of height 40 ft. He studied liquid unloading by injecting different types of surfactants and observing the flow behavior and pressure drop. Several parameters were evaluated like gas and liquid flow rates, surfactant concentration, surfactant type, pipe inclination, and diameter. As a result of foam generation, he observed reduced liquid film density causing the film to move upward

and lowering pressure gradient and fluctuations. The transition velocity to churn flow seen reduced for the presence of surfactant as compared to without surfactant. His work also mentioned that CMC and equilibrium surface tension properties are insufficient to decide which type of surfactant and what concentration of surfactant is required to decrease the pressure drop in the pipe [3].

A few other studies can also be considered as good resources for foam lift. Barreto (2016) [21] worked to identify the optimum surfactant delivery location on horizontal well deliquification. In her experiments, she used 2" ID set up comprised of 64 ft lateral pipe with sump and toe-up arrangement and then 41 ft vertical pipe. She used an anionic surfactant, at a fixed concentration above CMC with continuous surfactant injection at four different locations. She obtained improved unloading results in the lateral section when an external source of agitation was added. However, the surfactant showed significant liquid unloading improvement in the vertical section for all cases. She also noticed that the presence of a surfactant can reduce or fully eliminate the severe slugging and improve the unloading. Later, Gcali (2017) [4] studied the efficiency of surfactant batch treatment without external downhole agitation in horizontal gas wells. Her work set up was similar to that of Barreto with 1° inclination in the horizontal section and with the fixed location of anionic surfactant injection. She also mentioned the effect of liquid loading of surfactant concentrations which was seen prominently till CMC and after CMC it was insignificant. Both Barreto and Gcali used only air and water as their testing fluids and neglected the effects of

condensate presence. Like Gcali's method, the current study is focused on surfactant batch treatment in loaded wells.

The aforementioned studies were carried out with air-water flow systems. But as the fraction of condensates in loaded liquid increases, the foam lift efficiency reduces, which is evaluated in the current study. The study includes laboratory experiments, carried out with various surfactant types, surfactant concentrations, and water/condensate volumetric fractions. Initially, the surfactants are characterized by static and dynamic surface tension measurements. Foam lift assessment is then completed using a liquid unloading column that serves as a replica for a gas well. Foam lift efficiency is determined by measuring the foam density, foam half-life, and unloaded liquid. The outcome of this work sheds light on the performance of given surfactant types in the presence of varying amounts of condensates. The findings are intended to contribute as an operational guideline for selection of the surfactants to unload gas wells.

CHAPTER 3: EXPERIMENTAL SETUP

This chapter describes the general design of different stages of this experimental work. The main objective of this study was to characterize different surfactants in terms of their liquid unloading efficiency with varying water/condensate fractions. In this chapter, first, the selected surfactant types will be introduced and described. Then, the methods used to measure static and dynamic surface tensions of different types of surfactants are described. Lastly, the experimental setup used to conduct lab-scale liquid unloading tests is described.

3.1. Experimental Fluids

The experimental fluids for this study include deionized water, Isopar-L oil and five types of surfactants. The properties of the oil and selected surfactants are mentioned in the Appendix. 'High performance foams for unloading gas wells' [22], mentions about possible applicable surfactants groups for liquid unloading in gas wells. They are as follows:

Anionic: Alkyl sulfonates, alkyl sulfates, alkyl phosphates, fatty carboxylate [22], Alkyl (or alcohol) Ethoxy Sulfate (AES which are relatively more stable for high pH and salinity in presence of alkali also at an elevated temperature up to 83°C) [23].

Cationic: Monoalkyl quaternary amines, the specific example can be cetyltrimonium chloride. Dialkyl quaternary amines, e.g. dicetydimethyl ammonium chloride, etc.

Amphoteric: Alkyl betaines, alkylamido propyl betaines, alkylampho acetates.

CHAPTER 3

Nonionic: Alcohol ethoxylates

For this study anionic, cationic, nonionic, amphoteric types of surfactants are selected using the above reference [22] and two commercial surfactants which are provided by Halliburton are considered for foam tests.

A brief description of the selected surfactants is as follows:

Anionic:

The anionic surfactant selected is 'Alpha Olefin Sulfonates' i.e. AOS. The sample is supplied by Stepan Company under the name POLYSTEP A-18. Depending upon the number of carbon atoms, the molecular weight of AOS is in the range of 298.42 - 344.49. (average of 326 g/gmol). The concentration of surfactant is 39%. The Molecular Formula for the surfactant is $C_nH_{2n-1}SO_3Na$ ($n = 14 - 16$). AOS is thermally unstable [23].

Commercial Surfactant 1:

The first commercial surfactant provided by Halliburton (Multi-Chem Group LLC) is coded as MC 6400029 (Witcolate 1276). It is comprised of an anionic and non-ionic type of surfactant mixture with isopropanol as a cosolvent. The concentration of surfactant is in the range of 40-80%.

Commercial Surfactant 2:

The second commercial surfactant provided by Halliburton (Multi-Chem Group LLC) is coded as MC MX 4-1580. It is of anionic and non-ionic type of surfactant mixture

CHAPTER 3

with isopropanol as a cosolvent. The concentration of surfactant is in the range of 60-90%.

Cationic:

The cationic surfactant selected is Cetyl Trimethyl Ammonium Bromide (CTAB) purchased from VWR (Spectrum Chemical Mfg. Corp.). The molecular weight of CTAB is 364.45 g/mol. Linear Formula is $\text{CH}_3(\text{CH}_2)_{15}\text{N}(\text{Br})(\text{CH}_3)_3$ i.e. $\text{C}_{19}\text{H}_{42}\text{NBr}$. The concentration of the surfactant is 100%, and it was used in 40% weight concentration for this study.

Amphoteric:

The amphoteric surfactant selected is AMPHOSOL LB. This is comprised of lauramidopropyl betaine and myristamidopropyl betaine with the range of concentration 25-40 %. The sample is purchased by Stepan Company.

Non-ionic:

The non-ionic surfactant selected is MAKON DA-9. The sample is provided by Stepan Company. The chemical description is Decyl Alcohol Ethoxylate. The surfactant is used at 100% concentration.

Another non-ionic was selected which is BIO-SOFT EC-690. The sample is provided by Stepan Company. The chemical description is Ethoxylated Alcohols (C10-16). This Surfactant is available in the range of 89-91% concentration and used with the same concentration.

At the first stage of this study, the static and dynamic surface tension of different types of surfactants were tested.

3.2. Static Surface Tension Measurements

The surfactant solution samples were prepared using deionized water and varying concentrations of surfactants. Static surface tension measurements were performed using a Dynamic Contact Angle (DCA) analyzer (Wilhelmy plate). In this method, a glass plate is immersed in the surfactant solution in the direction perpendicular to the liquid surface. The dynamic contact angle is measured, which is the angle established during the wetting or de-wetting process of the solid glass plate [8]. The Wilhelmy plate which is a polished glass plate with dimensions of 22mm x 22mm, selected for the tests. The force involved during this process is a function of the surface tension, wetted length, and the contact angle. This force is measured during the immersing and removal of Wilhelmy plate. The formula for the force is illustrated in Figure 3.1, where 'γ' is surface tension in mN/m, θ is contact angle assumed to be 0 when liquid completely wets the glass surface, and L is the wetted length in mm.

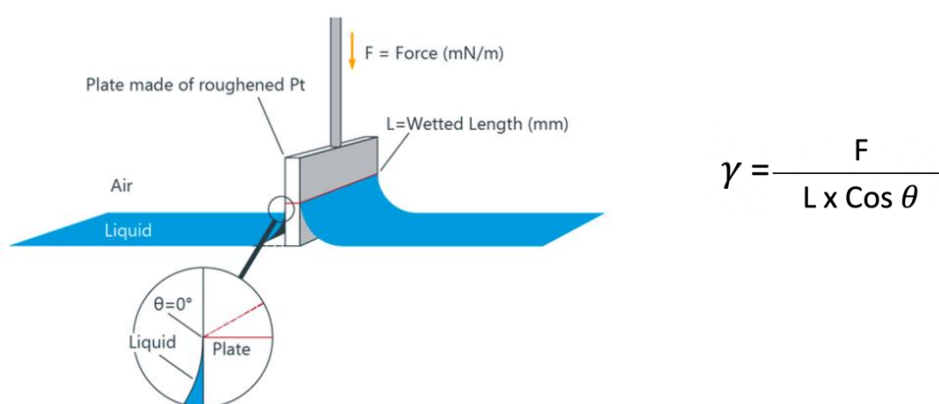

Figure 3.1. Schematic for the Dynamic Contact Angle analyzer ST tests [8]

The DCA instrument reflects the final surface tension (γ) value on the screen using the immersion and removal forces involved. This process is repeated multiple times for solutions with various surfactant concentrations. After obtaining the respective ST values, the CMC value is determined by observing a sharp change in the slope of the ST vs. concentration plot, resulting in the ST plateau for the given sample surfactant.

3.3. Dynamic Surface Tension Description

Dynamic surface tension measurements were obtained using a bubble pressure tensiometer as shown in Figure 3.3. In this method, the gas bubble is formed inside the liquid sample using a capillary tube. During this, initially, the radius of the bubble decreases and becomes equal to the radius of the capillary, and then it increases. The maximum internal pressure of the gas bubble is obtained when the radius of the bubble is equal to the radius of the capillary [8]. Figure 3.2 shows the changes in bubble radius and internal pressure as the bubble leaves the capillary. Using the maximum pressure, the surface tension is calculated with the formula shown in Figure 3.2.

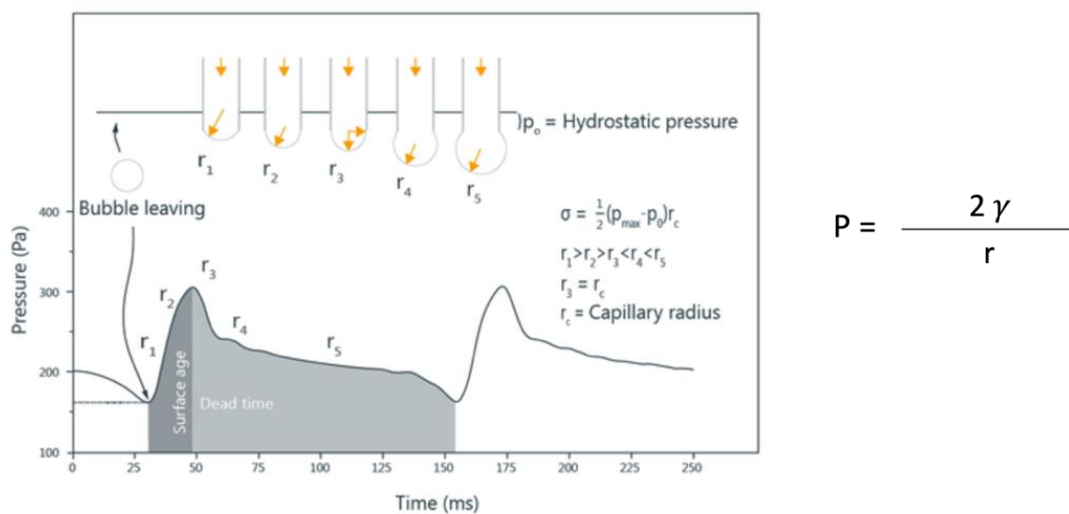

Figure 3.2. Bubble Pressure Tensiometer Testing Method [8]

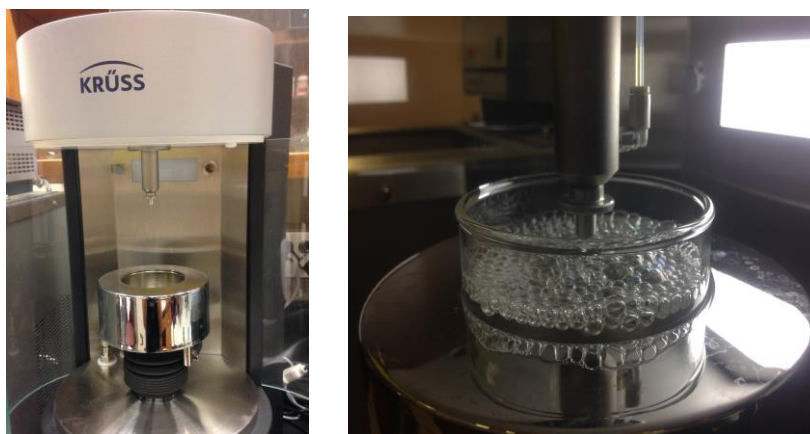

Figure 3.3. DST measurement using Bubble Pressure Tensiometer

The time it takes, from the generation of the interface to reach the maximum bubble internal pressure is called the surface age. For a particular concentration, initially, the surface tension is high, and the time required for the bubble formation is less i.e. surface age is less. Over time, surface tension decreases, and the surface age increases, i.e. bubbles take longer to form [8].

The outcome of dynamic surface tension measurement is a plot of surface tension with surface age. This plot shows the diffusivity of the surfactant molecules. If the rate of diffusivity is high, the rate of reduction of surface tension ($d\gamma/dt$) is high. Dynamic surface tension is simply a time-dependent value of static surface tension. This method compares the rate of reduction of surface tension for different surfactants with different concentrations. The measurement of dynamic surface tension can be used to better understand the mobility of surfactant molecules in the solution. The rate of adsorption of surfactant molecules at the air-water interface is a function of concentration in the bulk, structure of surfactant and the surface activity. Using DST plots, the surface tension gradient is correlated with the foamability of surfactants [7].

3.4. Unloading Column Setup and Procedure

The experimental setup used for this work consists of a vertical production column, a connecting arm, and a collection column. The production column is of dimensions of 7 cm (2.75") outer diameter (OD), 93.5 cm (37") height, and 1 cm thickness. At the bottom, it is equipped with a 5 cm (~2") diameter, 0.125" thick, 22-micron ceramic sparger. The collection column is of dimensions of 17.7 cm (7") OD, 61.5 cm (24.2") height, and 0.5 cm thickness. The Connecting arm is 54 cm (21") long, 7 cm (2.75") OD and 1 cm in thickness. The material of the setup is acrylic plastic.

High-pressure N₂ cylinders (2000 psi) are used as a source of pressurized gas, connected to the bottom of the production column. The connecting tubing for N₂ supply to the foam production column is of ¼ inch Silicon tubing. Foam is generated

by sparging N_2 into the prepared surfactant solution in the production column. An inline pressure regulator is used to limit the maximum downstream pressure to 200 psi, so that it will not exceed the maximum allowable pressure of the downstream pipe. A control valve is installed after the pressure regulator to control the flow rate. A flow meter is installed after the control valve to monitor the flow rate of 10 lit/min. This translates to an approximate superficial gas velocity of 0.3 ft/s for all of the conducted tests. All the deliquification experiments are carried out at near-atmospheric pressure and room temperature of 25°C. Figure 3.4 shows the schematic of the liquid unloading column setup. Figure 3.5 is the picture of the actual setup in the laboratory.

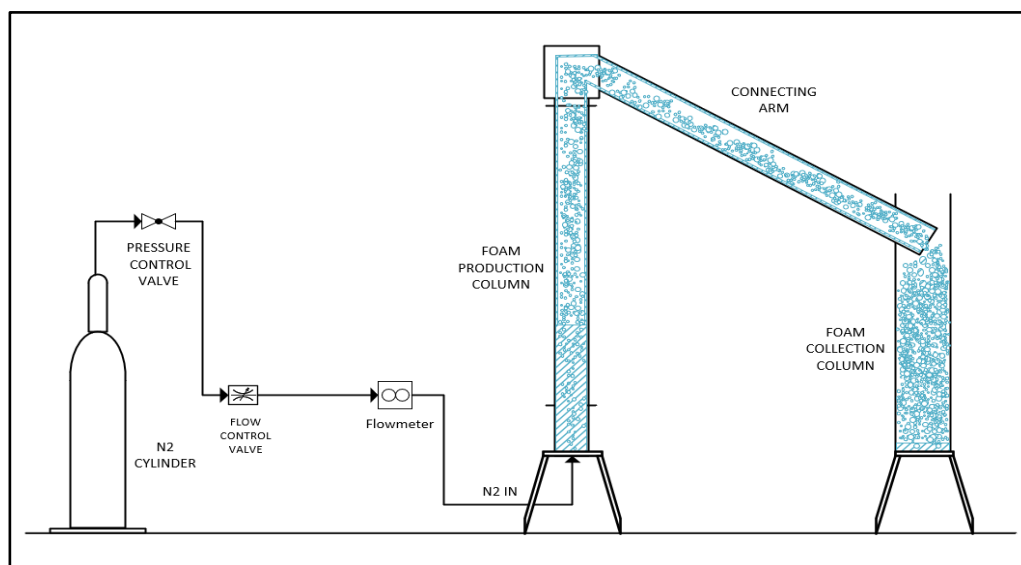

Figure 3.4. Schematics of Liquid Unloading setup



Figure 3.5. Liquid Unloading experiment setup

The equipment is properly connected, making sure no leakage of N_2 and/or liquid is taking place, particularly at the joints. In a regular experiment, the 300-ml water sample, mixed with a surfactant of a known concentration, is poured into the production column. In the next step, N_2 gas is allowed to enter the column with a flow rate of 10 lit/min. As the N_2 is sparged into the production column, the foam generation starts. Foam starts flowing to the top of the column and then through the connecting arm and finally collected at the collection column. The tests are stopped, by closing the N_2 valve when the liquid or foam stops reaching the top of the production column. This is considered as an indicator of maximum unloading under the given conditions.

In most of the experiments, the foam unloading from the production column takes place within the first 2-3 minutes. During this time, the foam production is initially continuous, then in form of slugs or churn flow of foam and then in annular flow

pattern where N_2 passes through the pipe centerline and foam flows as layers upwards along the sides of the production column.

A stopwatch is used to record the time from the moment that foam production is started. The foam height, liquid drainage, and the final liquid level readings in the collection column are noted down every minute for 60 minutes. For the cases with no oil, sometimes foam decay persists beyond 60 minutes. For the cases with oil, the observed foam decay durations are much shorter compared to the cases without oil. Finally, the remaining surfactant solution in the production column and the unloaded liquid (after foam decay) in the collection column are measured using the measuring cylinders.

To analyze foam stability, foam height is measured with time providing the rate of foam decay. Simultaneously liquid drainage rate is measured with time. The foam stability can also be analyzed based on the foam half-life, which is the time required for the foam to decay to half of its recorded maximum height. A similar method is used for this experimental work. Foam and liquid height over the foam decay time are used to characterize the foam stability, foam density, and foam quality. Foam quality and density are explained in detail in section 4.7 and 4.8. The first phase of testing was conducted for a base case of liquid unloading without any surfactant and with 100%, 90%, 70%, and 50% water cuts. No unloading was observed for these cases due to very low gas rates. As per Gcali's study [4], not a significant improvement in liquid unloading was observed for surfactant concentrations beyond CMC. Therefore, for

this study three concentrations were selected for the unloading tests, below CMC, at CMC and above CMC. The surfactant concentrations are reported in parts per million (ppm). The results were compared for all surfactant types and concentrations, with four water cuts, including 100%, 90%, 75%, and 50% water in the liquid phase.

Deionized water was used as the aqueous phase. The light hydrocarbon used for this study was Isopar L model oil, supplied by ExxonMobil Chemical Company. The oil has a specific gravity of 0.76, molecular weight of 162 g/gmol, pour point of -69° C, flash point of 62° C, and boiling point of 190° C. The properties of this oil simulate the characteristics of condensates in wet gas wells, making the comparison more realistic.

3.5. Unloading Experimental Setup for high temperature

High temperature tests are carried out at 50°C for the selected test matrix. The same liquid unloading setup is utilized with the addition of an inline air heater. The inline air heater is installed after the flowmeter. The preheated surfactant solutions in a temperature range of 50-60 °C are poured into the production column. The production column and connecting arm are insulated to restrict heat losses.

Temperature is monitored at the bottom of the production column. An additional temperature gauge is installed at the outlet of the air heater. This is used to monitor the temperature difference between the outlet of the heater and the column bottom. Column bottom usually has some residual liquid. Evaporation of this liquid and raising the temperature at column bottom takes approximate 20-30 minutes. By monitoring the first temperature gauge, it is also made sure that N₂ supply pipe is not

overheated. The objective is to maintain the temperature within the range of 40-55 °C. The liquid unloading for most of the tests takes place within the first 2-3 minutes, during which the column temperature was reasonably close to 50 °C.

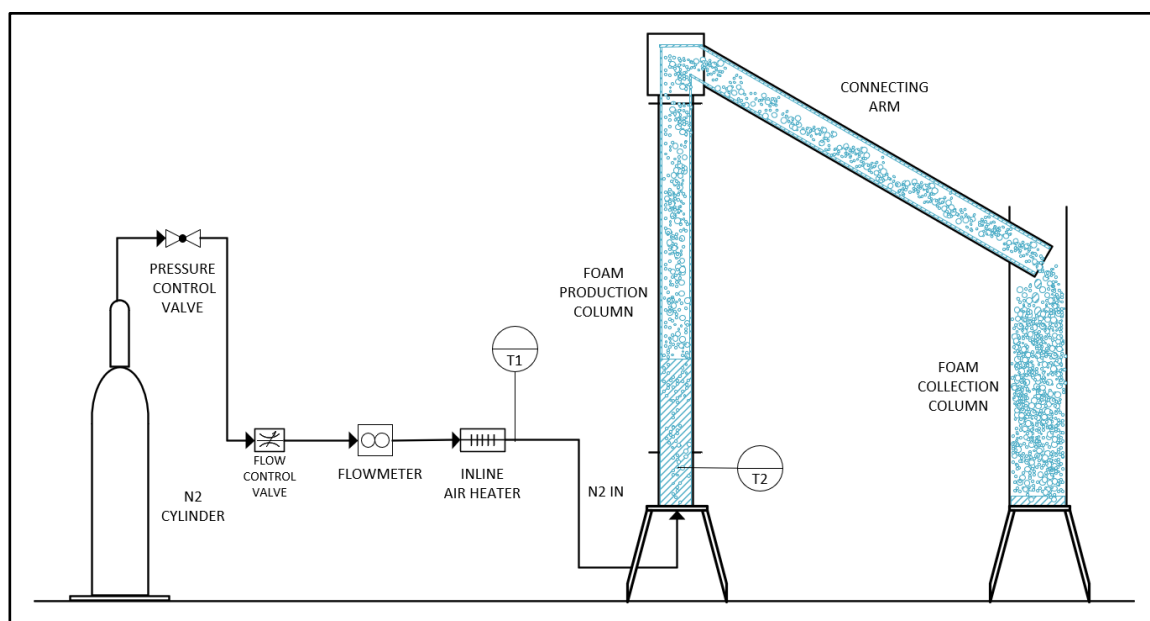

Figure 3.6. Schematics of Liquid Unloading setup for high temperature

The collection column is not protected from heat losses and is exposed to room temperature. The heat losses and evaporation losses of solution are not avoided there. Refer Figure 3.6 for high temperature tests setup. All the other parameters and testing conditions are kept the same as the room temperature tests. The readings are also taken in the same way as room temperature tests. The test matrix is simplified for time saving purposes, covering two cases for all the tested surfactant types: at CMC with 100% water cut and at CMC with 75% water cut. The results are compared with the respective room temperature tests.

CHAPTER 4: READINGS, RESULT AND DATA ANALYSIS

This chapter discusses the experimental results from all the phases of this study. First the surfactant characterization tests to measure static and dynamic surface tensions will be presented. Then, the tests conducted with the lab-scale liquid unloading column will be evaluated. Lastly, the high-temperature tests with the same setup will be discussed to analyze the effects of temperature on surfactant efficiency.

4.1. Static Surface Tension - CMC Readings

As discussed in Chapter 3, static surface tension of each surfactant was characterized using a dynamic contact angle (DCA) analyzer. Figure 4.1 shows these measurements for all the surfactants at varying concentrations. These measurements were used to determine the surfactant CMC values. The CMC is estimated as the concentration where the slope of concentration vs. surface tension plot changes sharply. These CMC values are presented using the dashed lines with corresponding colors for each surfactant. The measurements were obtained at room temperature (25°C) with deionized water solution.

Table 4.1 shows the summary of tested surfactant types and their respective CMC values. Note that CTAB (C) means CTAB with isopropanol as cosolvent, and CTAB (NC) means CTAB without a cosolvent. Also, surface tension tests using DCA (i.e. Wilhelmy plate) are not available for water-oil mixtures. The presence of isopropanol as cosolvent increases the solubility of CTAB at room temperature and contributes to

a better foamability. The CMC value for CTAB using isopropanol are reduced as compared to without it.

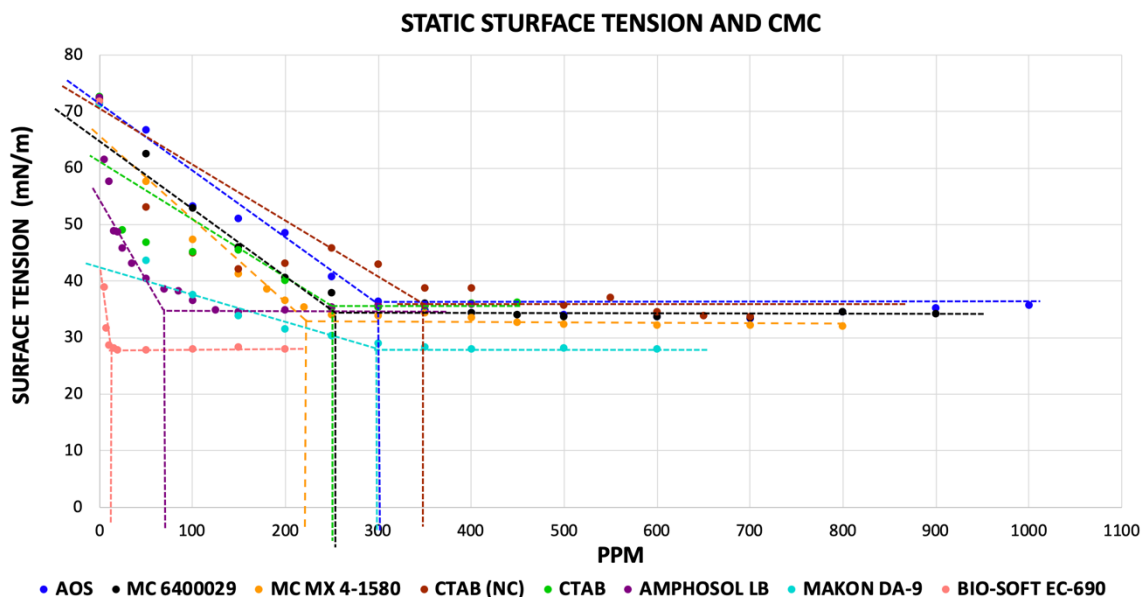

Figure 4.1. Static Surface Tension (mN/m) Measurements for Various Surfactants

Table 4.1 shows the summary of different types of surfactants tested, and their respective CMC values. Note that CTAB (C) means CTAB with cosolvent isopropanol, and CTAB (NC) means CTAB without cosolvent. Surface tension tests using DCA (i.e. Wilhelmy plate) are not available for water-oil mixtures.

CHAPTER 4

Surfactant Name	Type	CMC (in PPM)
POLYSTEP A-18 (Alpha Olefin Sulfonates)	Anionic	300
Commercial Surfactant 1: MC 6400029 (Witcolate 1276)	Anionic + Nonionic	250
Commercial Surfactant 2: MC MX 4-1580	Anionic + Nonionic	220
CTAB (Cetyl Trimethyl Ammonium Bromide)	Cationic	350 without cosolvent (NC) 250 with cosolvent (C)
AMPHOSOL LB	Amphoteric	70
MAKON DA-9	Nonionic	300
Biosoft EC-690	Nonionic	10

Table 4.1: CMC values of surfactants

4.2. Static Surface Tension and CMC at 50 °C.

Measurements of CMC at 50 °C were done using the same instrument, Dynamic Contact Angle (DCA) analyzer. The deionized water with varying surfactant concentrations was heated to 55 °C and tested for ST in the temperature range of 50-55 °C. The DCA instrument is not equipped to provide insulation or maintain the temperature during the ST tests. Hence the tests are conducted in an approximate temperature range and not exactly at 50 °C. Figure 4.2 shows the resulting surfactant concentration vs. surface tension plots for various surfactants, with CMC values outlined with dashed lines.

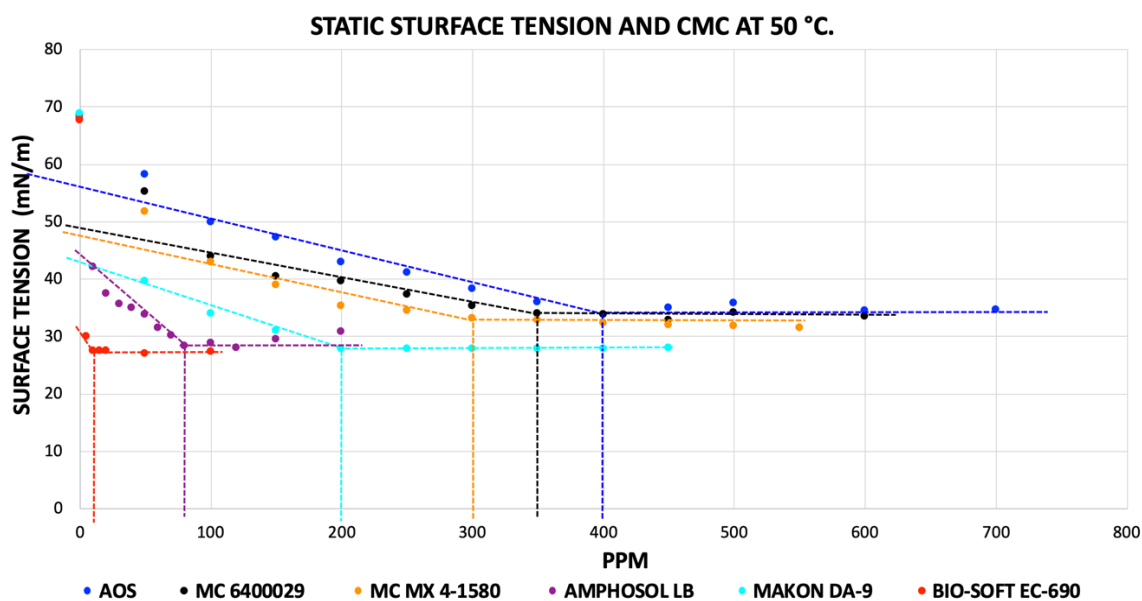

Figure 4.2. Static Surface Tension Measurements at 50 °C for Various Surfactants

It is observed that at the higher temperature the range of CMC is extended. Which means surface tension change with respect to concentration is taking place in a more gradual way at high temperature. Whereas CMC at room temperature was seen with a sharper angle. For the 50°C temperature, the CMC values of AOS and commercial surfactants, which are mixtures of anionic and non-ionic, were increased. Amphosol showed a slight increase. For Makon a decrease in CMC was observed, while Biosoft did not show much change. Surface tension measurements of CTAB at 50 °C were not possible using the Dynamic Contact Anger (DCA) analyzer. The readings obtained were erratic for the CTAB solution. The values obtained are listed in Table 4.2.

Surfactant Name	Type	CMC (in PPM) at 50 °C	CMC change w.r.t. ambient temperature
POLYSTEP A-18 (Alpha Olefin Sulfonates)	Anionic	400	100 (increase)
Commercial Surfactant 1: MC 6400029 (Witcolate 1276)	Anionic + Nonionic	350	100 (increase)
Commercial Surfactant 2: MC MX 4-1580	Anionic + Nonionic	300	80 (increase)
CTAB (Cetyl Trimethyl Ammonium Bromide)	Cationic	NA	NA
AMPHOSOL LB	Amphoteric	80	10 (increase)
MAKON DA-9	Nonionic	200	100 (decrease)
Biosoft EC-690	Nonionic	10	No change

Table 4.2: CMC values of surfactants at 50 °C

As there is no consistent and significant change in the CMC values at 50 °C compared to room temperature, the decision was made to use similar surfactant concentration in liquid unloading tests.

Observations on solubility at elevated temperature: Biosoft used in this study has a poor solubility at room temperature. Refer Figure A.19 which shows how it forms a gel as it comes in contact with water and remains in undissolved gel structure for a longer time. It took approximately 20-30 minutes to dissolve it while preparing the solution. As the temperature increases, the solubility is seen increased.

CTAB showed increased solubility at elevated temperature compared to room temperature. Therefore its foamability was also increased.

4.3. Dynamic Surface Tension Readings

Dynamic Surface Tension is a time-dependent characteristic of surfactants, denoting the time-dependent surface tension. Figure 4.3 shows the dynamic surface tension for AOS. This graph shows the surface tension measurement with surface age (ms), at increasing concentrations. The DST measurement of water with no surfactant is also included in the plot, indicated as zero ppm. As the concentration increases the transportation speed of surfactant molecules to the surface increases. Hence the dynamic adsorption process becomes faster and a sharper surface tension gradient is seen [14]. Each surfactant has a different dynamic behavior with increasing concentration. The figures for other surfactants involved in the tests are included in Appendix A.1.

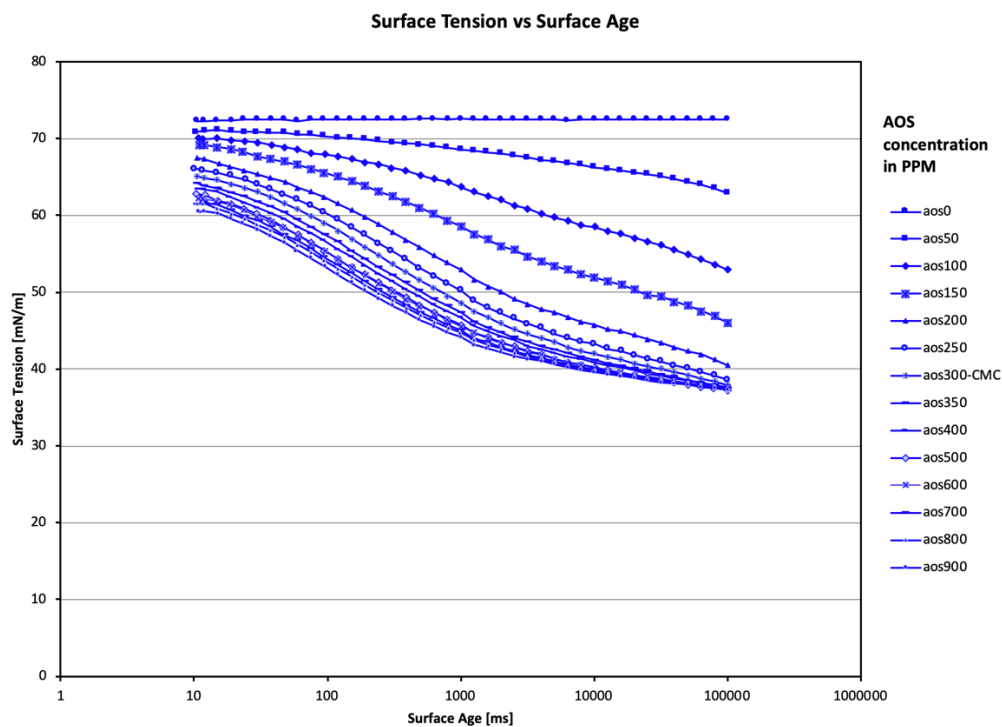

Figure 4.3. DST Tests for AOS

AOS shows a smaller surface tension gradient below CMC. Near and above CMC (300 PPM) the slope of the ST gradient increases noticeably. The surface tension gradient is increased, and the equilibrium surface tension is achieved faster as the surfactant concentration is increased. At higher concentrations, the difference in the ST gradient lines gets smaller and smaller.

Figure A.1 shows the DST plots for all the remaining surfactants. As compared to AOS, both commercial surfactants take longer times in terms of reducing the surface tension as the gradient of ST is smaller. DST plot for Makon shows an immediate reduction in surface tension with a higher gradient. For CTAB in the presence of isopropanol, the slope for the ST gradient is increased and equilibrium is achieved at lower concentrations, as the solubility of surfactant in water is increased. For Biosoft, surface tension is reduced at very low concentrations, but there is a delay in surface tension reduction. In the DST plot of Biosoft, it is seen that after initial time lag ST reduces faster, making surface tension gradient for Biosoft higher than any other surfactants.

The dynamic surface tension behavior of different surfactants varies with their molecular structure. The commercial surfactants achieve the equilibrium surface tension slower compared to the pure surfactants. This could be the effect of the presence of isopropanol as a cosolvent in the surfactant mixture. In addition, the amphoteric surfactant takes the longest time to perform among the pure surfactants.

Figure 4.4 shows the DST plots to compare the dynamic behavior of all the surfactants at their respective CMC values.

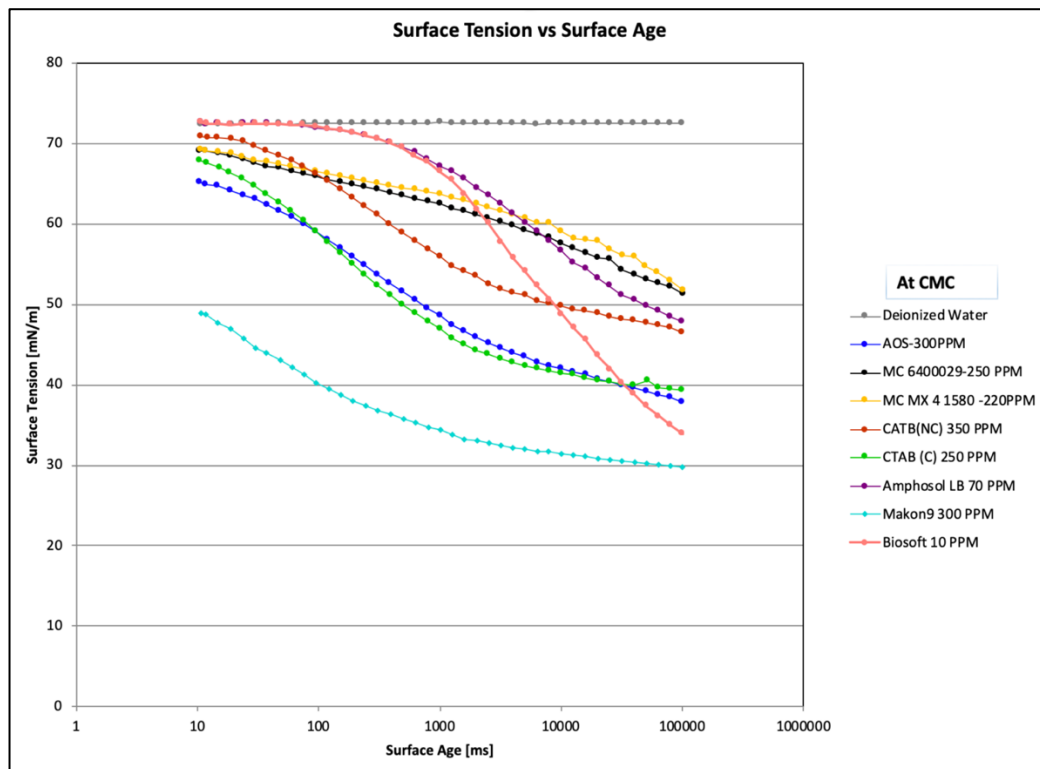

Figure 4.4. Dynamic Surface Tension Measurements for All Surfactants at CMC

The DST plot is made up of four regions, which are i) induction region ii) rapid fall region iii) meso-equilibrium region and iv) equilibrium region [7] [6] [24] [14]. Figure 4.5 shows these regions using the DST plot of Biosoft at three concentrations, below CMC, at CMC and above CMC.

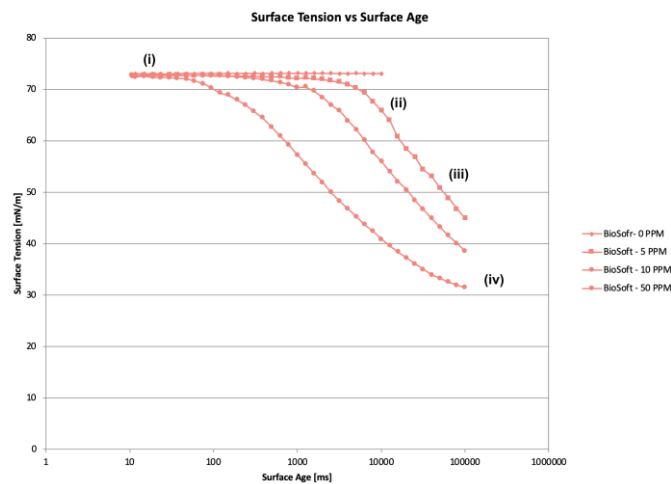

Figure 4.5. Dynamic Surface Tension Regions

Equation 4.1 shows the surface tension changes during the first three regions [6] [7] [24]

$$\gamma_t = \gamma_m + \frac{(\gamma_o - \gamma_m)}{[1 + (t/t^*)^n]} \quad (4.1)$$

where γ_t is the dynamic surface tension at time t , γ_m is the meso-equilibrium surface tension, γ_o is surface tension of pure water, t^* is the time required to attain a half value between γ_o and γ_m , and n is a fitting constant obtained using the actual data.

Values of t^* and n can be obtained by fitting the above equation into the measured DST values. t^* depends on the diffusion rate of surfactant from the bulk to the interface. If t^* is small, the diffusion rate is high. The n value depends on molecular structure. The higher the n value is, the less likely it is for a surfactant molecule to get adsorbed and desorbed at the interface. As the concentration increases the n and t^* values decrease as there are a greater number of molecules and a higher diffusion rate [6] [7] [24].

For finding the time required for a maximum change in surface tension i.e. $(\partial\gamma/\partial t)_{max}$, the above equation is differentiated to equation 4.2 and then determined for time $t = t^*$.

$$-\frac{d\gamma}{dt} = \frac{(\gamma_o - \gamma_m)[n(t/t^*)^{n-1}]}{t^*[1 + (t/t^*)^n]^2} \quad (4.2)$$

At time $t = t^*$, the value of dynamic surface tension is maximum. Equation 4.3 shows this maximum value as a function of n and t^* .

$$\left(\frac{\partial\gamma_t}{\partial t}\right)_{max} = \frac{n(\gamma_o - \gamma_m)}{4t^*} \quad (4.3)$$

Value of n , t^* , and $(\partial\gamma/\partial t)_{max}$ are calculated and compared for each surfactant at three concentrations, below CMC, at CMC and above CMC. Table 4.3 shows these values for all the surfactants. In this table, it is seen that the n and t^* values decrease for a particular surfactant as the concentration increases. An increase in concentration causes increased driving force for surfactant molecules to travel to the surface, increasing the surface tension gradient and hence reducing n and t^* values. Foamability and foam stability values are referred to in the below table are the results obtained from foam unloading tests for 100% water case, section 4.5.1, 4.9.

CHAPTER 4

	Concentration PPM	n	t* (ms)	$\left(\frac{\partial \gamma}{\partial t}\right)_{max}$	Foamability max foam height(cm)	Foam Stability or Half-life (min)
AOS	100	2.49	185140	0.000066	18.85	8.5
	300	1.38	88140	0.000116	63.05	13.5
	500	1.09	66190	0.000131	62.2	15.5
Commercial Surfactant 1 (MC 6400029)	100	2.00	268910	0.000023	6.3	1
	250	1.13	167090	0.000036	21.4	6
	500	0.85	117550	0.000056	27.5	13
Commercial Surfactant 2 MC MX 4-1580	100	2.27	237120	0.000031	4.7	1
	220	1.92	213490	0.000047	10	1.5
	500	0.59	143030	0.000034	17.45	4
MAKON DA-9	100	0.76	45290	0.000139	4.15	3
	300	beyond the range	beyond the range	beyond the range	11.6	3.5
	500	beyond the range	beyond the range	beyond the range	14.45	3.5
CTAB	100	2.46	149100	0.000074	11.5	1.5
	250	1.53	86190	0.000135	63.5	11.5
	500	1.35	51820	0.000206	83	10
AMPHOSOL LB	25	4.05	372510	0.00004	2.7	5
	70	3.90	240670	0.00010	15.3	13
	150	3.85	203370	0.00015	35.8	12
Biosoft EC-690	5	2.44	376210	0.000046	1.5	3.5
	10	2.27	307280	0.000064	3.5	13
	50	1.89	178740	0.000104	14.5	12.5

Table 4.3: Dynamic Surface Tension Parameter and Foam Characteristics for all Surfactants

The n and t^* values can be used to compare the tested surfactants. For example, as observed in Table 4.3, for AOS at 100 ppm, n value is higher than commercial surfactants. The interpretation from this is the higher potential barrier for adsorption of AOS molecules to the surface. The n and t^* values for Makon at 300 and 500 ppm (i.e. at CMC and above CMC) are described as “beyond the range of the plot”. The reason is that the reduction in surface tension starts early, before the starting time range of the DST tests.

The t^* values also show a good comparison for different surfactants. The decrease in t^* means an increase in the diffusivity rate. For example, the t^* for AOS at 100 ppm is 185140 ms and for commercial surfactant 1, it is 268910 ms, which means the commercial surfactant has a slower diffusion than AOS.

The maximum change in dynamic surface tension reduction i.e. $(\partial\gamma/\partial t)_{max}$ is related to foamability [7] [6]. Calculated values for $(\partial\gamma/\partial t)_{max}$ and foamability obtained from experiments are in a good agreement. As the concentration increases the foamability and maximum change in dynamic surface tension increase. Foamability is measured in terms of maximum foam height. Foam stability also increases with increased concentration.

4.4. Liquid Unloading test results

The unloading tests are conducted using the experimental setup described in Chapter 3. The tests are carried out for all the considered surfactants, at three surfactant concentrations i.e. below CMC, at CMC and above CMC, and four water cuts i.e. 100%, 90%, 75%, and 50%. The experimental results are presented in the following sections.

Once the experiment is started and foam is unloaded in the collection column, the foam height and the drained liquid height are measured with time for all the cases. Readings are taken every minute for a 60-minute duration. Once the foam collapses completely, the final unloaded liquid and remaining liquid are measured. These readings are used to determine foam efficiency in terms of liquid unloaded and maximum foam height. Foam stability is determined in terms of foam half-life. Also, properties like foam density and foam quality are obtained.

4.4.1. *Foam Height and Liquid Unloading, No Oil*

Figures 4.6 and 4.7 show the changes in foam height and unloaded liquid height with time, for three tests conducted with AOS as the surfactant and no oil in the liquid

phase. The tests are completed with surfactant concentrations of 100, 300, and 500 ppm. Since the production time is shorter than 3 minutes, the foam height peaks at around 3 minutes for all cases. Then, it gradually decreases with foam breakage until the foam is completely collapsed. On the other hand, the liquid height gradually increases with time as the liquid drains out of the foam structure. The cases with concentrations of 300 ppm (around CMC) and 500 ppm (above CMC) show significantly larger foam heights compared to the case of 100 ppm (below CMC). As a result, these two concentrations have larger drained liquid heights and better unloading efficiencies. The differences between 300 and 500 ppm cases, however, are much less noticeable [25].

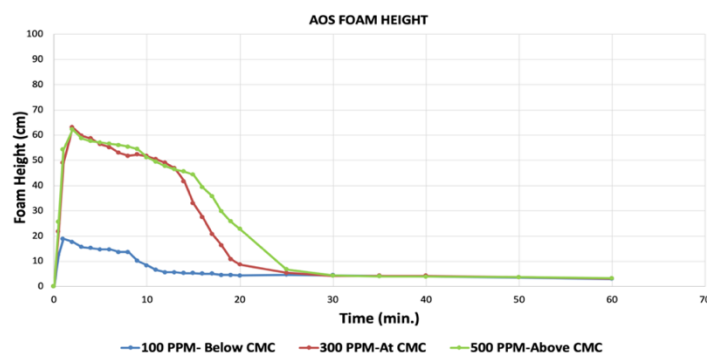

Figure 4.6. Changes in Foam Height with Time for AOS and no Oil case

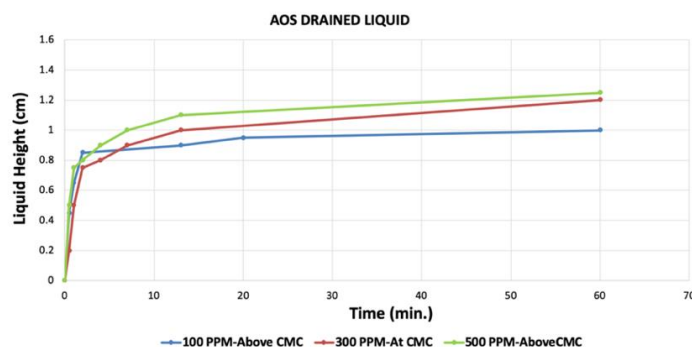

Figure 4.7. Changes in Unloaded Liquid Height with Time for AOS, no Oil

CHAPTER 4

The readings for all other surfactants are shown in the appendix A.2. Similar trends are observed for all the surfactants except Biosoft, regarding the concentration effects. For commercial surfactants, which are mixtures of anionic, non-ionic, and isopropanol, foam heights are less than AOS. This is partly because, during the experiments with commercial surfactants, the foam was observed to collapse as it passed through the connecting arm. Hence unloading was seen more in the form of liquid and less foam. The foam produced by AOS is relatively rigid and dense as compared to the commercial surfactants, as shown in Appendix A.11.

Maximum foam heights for all the surfactants with 100% water cut are summarized in Figure 4.8. The trend of increasing foam height with increased concentration is seen for all surfactants. For Makon, the liquid unloaded is higher than AOS, but the foam height obtained is less. The bubble size of CTAB was seen maximum during the experiments, resulting in the largest foam heights as shown in Figure 4.8. Biosoft shows the poorest performance, with the least foam height and the lowest amount of unloaded liquid.

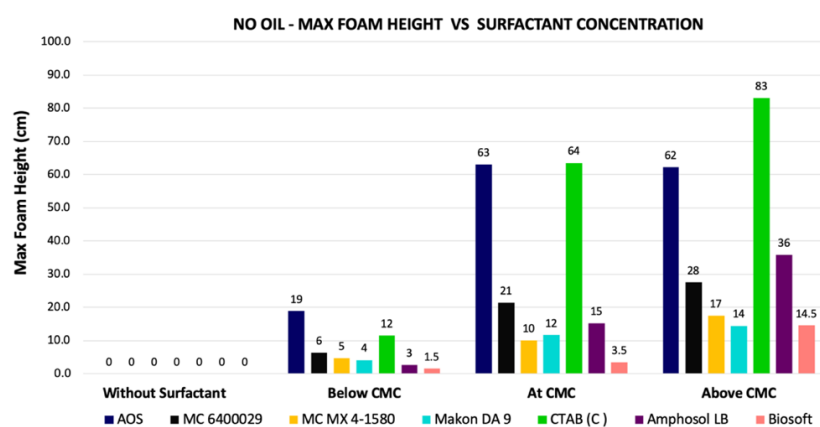

Figure 4.8. Maximum Foam Height for all Surfactants, no Oil

CHAPTER 4

Drained liquid volume is a good representative of final unloaded liquid volume, which is summarized in Figure 4.9. It shows the volumes of unloaded liquid, accumulated at the collection column for all the tests with no oil in the liquid phase. These volumes are out of 300 ml of initial liquid volume in the production column. As previously stated, no liquid unloading was observed in the absence of a surfactant. All surfactant types show acceptable liquid unloading performances in absence of oil, except Biosoft. The efficiencies for other surfactants are very high and increase at concentrations around or above CMC. The best performance belongs to Makon above CMC with around 95% liquid unloading.

In terms of unloaded liquid, the commercial surfactants also show good performances for 100% water case, despite noticeably lower foam heights compared to AOS. This means that although the foam breaks much faster with commercial surfactants, they do well in liquid unloading. Unloaded liquid for Amphosol and Biosoft follows the trend of foam height, with lower unloaded volumes and lower foam heights.

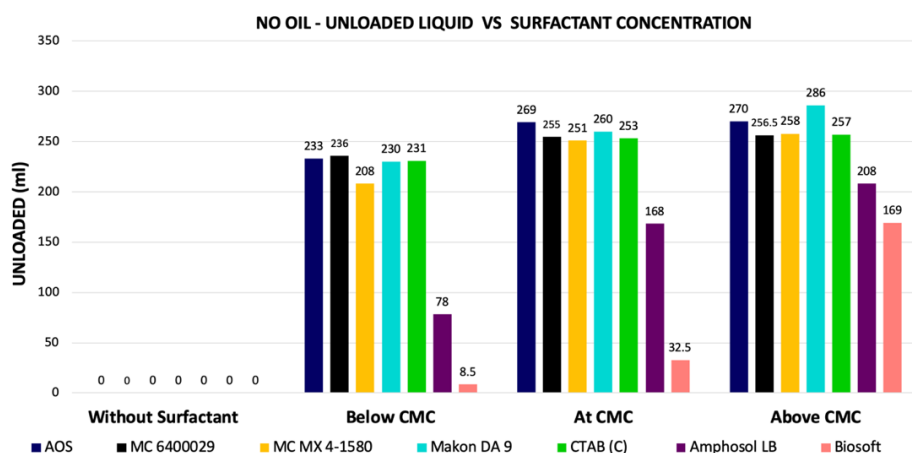

Figure 4.9. Unloaded Liquid Volumes for all Surfactants for No Oil case

The remaining liquid volume in the production column was also measured, as shown in Figure 4.10 for all surfactants and concentrations. The results are presented to cross-check the liquid losses during the experiments. The amounts of unloaded and remaining liquid volumes have to sum up to 300 ml, the initial liquid volume. As expected, the remaining liquid volume follows an opposite trend to that of unloaded volume. For no oil case, there are relatively negligible liquid losses recorded, going up to 2.5% of the initial volume. This missing volume of liquid can be due to negligible evaporation and unrecovered liquid remaining in the connecting arm.

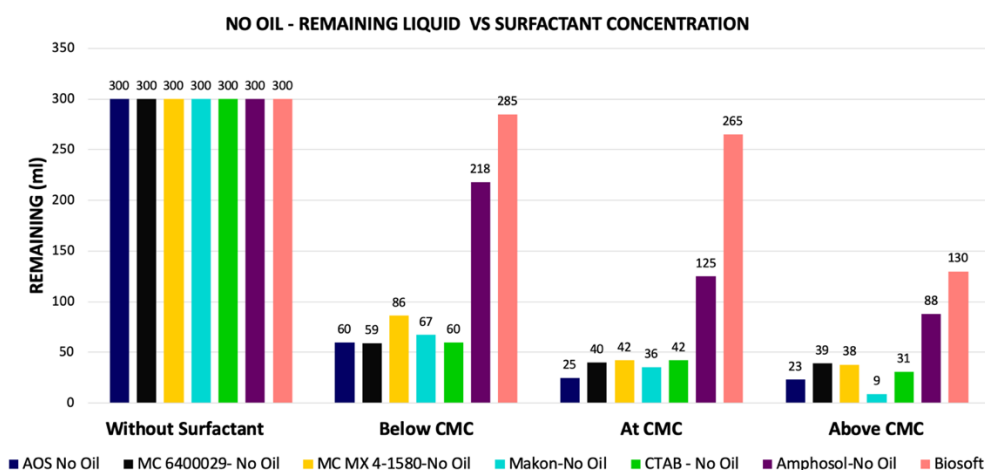

Figure 4.10. Remaining Liquid Volumes for all Surfactants for no Oil

Remaining liquid volume in the production column is also measured (refer Figure 4.10) to cross-check the losses during the experiments or in case there is unrecovered liquid after the experiment. The remaining liquid volume follows a trend opposite to that of unloaded volume. For no oil case, there are relatively fewer losses recorded which is up to 2.5% of initial poured volume. There is no emulsion seen for no oil case. Therefore, the missing volume of liquid can be due to unrecovered liquid only.

4.4.2. *Foam Height and Liquid Unloading, 10% Oil case*

Figures 4.11 and 4.12 show the foam height and unloaded liquid height trends with time for the three conducted tests with AOS and with 10% oil fraction in the liquid phase (90% water cut). Similarly, the results are presented with surfactant concentrations of 100, 300, and 500 ppm. These cases were selected to show an example of the effects of oil presence on foam generation. These graphs show substantial decreases in foam generation as compared to the case with no oil, shown in Figure 4.6. Also, the generated foam is seen to collapse very quickly. The liquid unloaded is also reduced significantly due to the presence of oil. The figures for foam and liquid height trends of all the remaining surfactants with 10 % oil fraction in liquid are also presented in the appendix A.3. Similarly, significant decreases in foam and liquid height were observed for all cases.

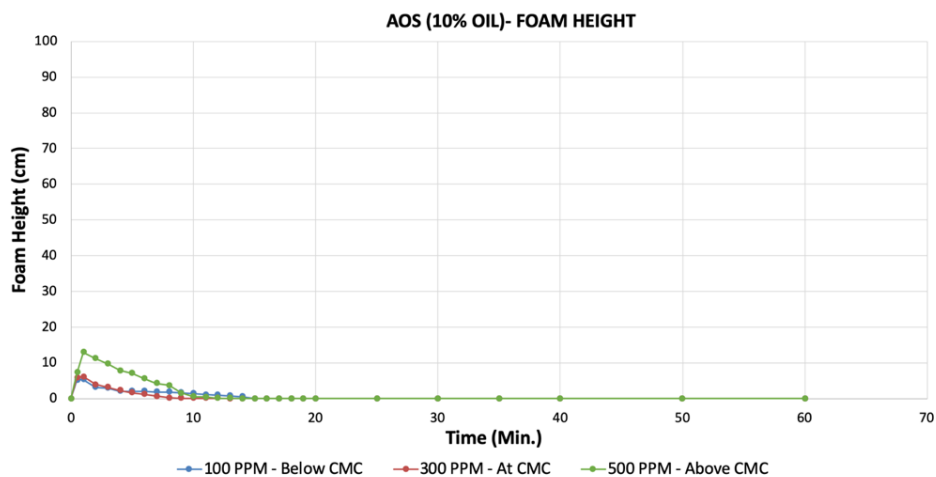

Figure 4.11. Remaining Liquid Volumes for all Surfactants for No Oil case

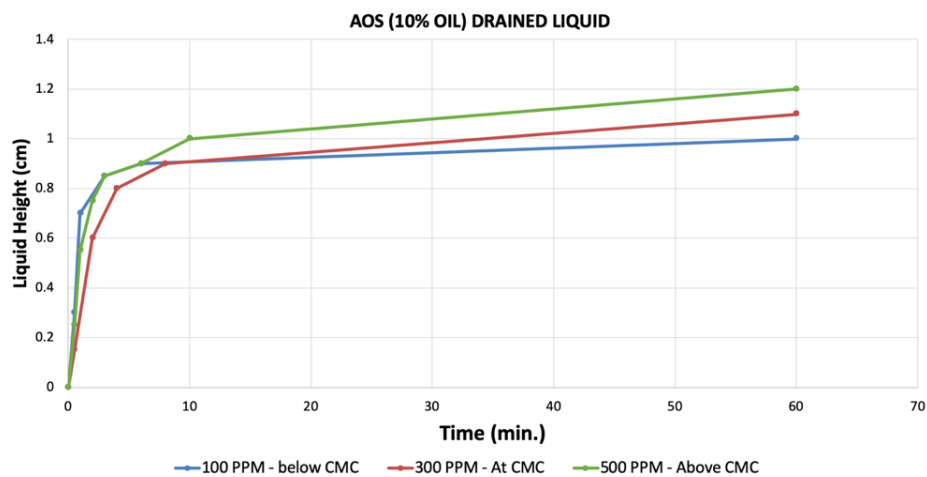

Figure 4.12. Changes in Unloaded Liquid Height with Time for AOS and 10% Oil

Maximum foam heights for 10% oil and 90% water cut cases with all the surfactants are summarized in Figure 4.13. Foam height is impacted drastically for all the cases as compared to no oil cases. AOS sustained the foam height with 10% oil cases better than other surfactants. The foam height decreased significantly for both commercial surfactants in the presence of 10% oil. Biosoft failed to perform for a 10% oil case and there was no foam generation or liquid unloading. This trend continued for all the other cases with increased oil fraction, as Biosoft could not unload any liquid. For Biosoft, small amounts of foam in the production column hardly reached the top of the column for the above CMC case, but could not unload any liquid.

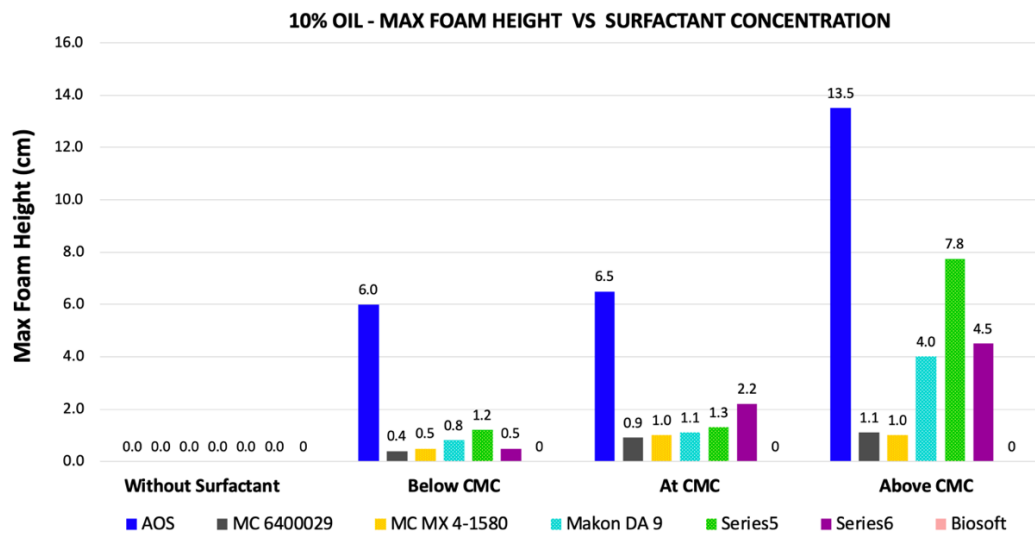

Figure 4.13. Maximum Foam Height for all Surfactants for 10% Oil case

Figure 4.14 shows the unloaded liquid volumes for all surfactant types and concentrations with a 10% oil fraction. No unloading is observed for the case with no surfactant. Unloading performances of all surfactant types are reduced, compared to the case with no oil. The reason is the reduced foam generation in the presence of oil, considering that the foam structure is the primary means for liquid unloading. Makon DA 9, AOS, and CTAB maintain relatively good performances for 10% oil fraction, with the smallest drops in unloaded liquid volumes as compared to no oil cases. Except for Biosoft, the overall unloading performance is still acceptable for almost all cases, despite the increased oil fractions. However, with Biosoft, the liquid unloading is fully diminished. Also, Figure 4.15 shows the remaining liquid volumes in the production column for all cases.

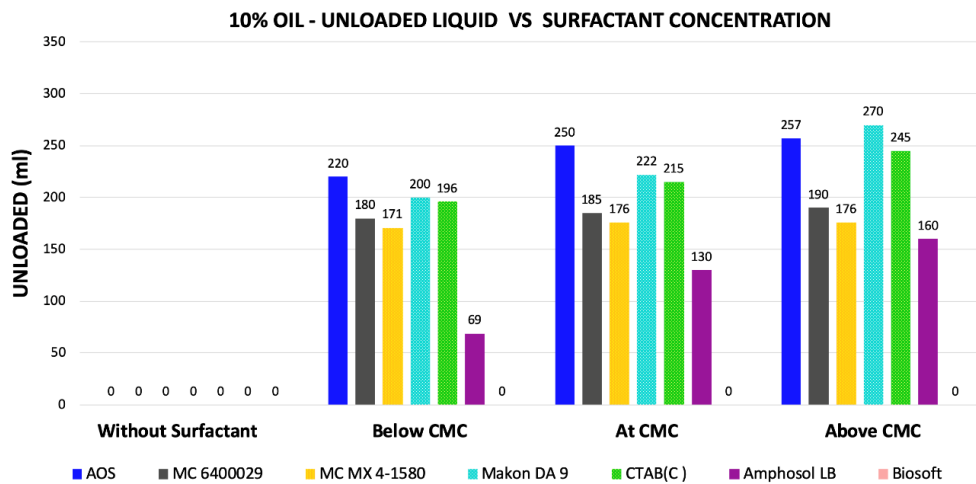

Figure 4.14. Unloaded Liquid Volumes for Different Surfactants with 10% Oil case

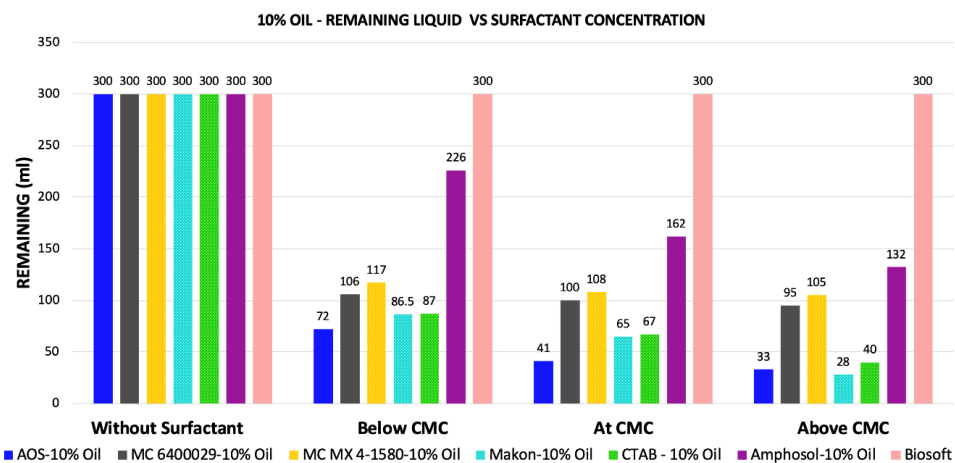

Figure 4.15. Remaining Liquid Volumes for All Surfactants with 10% Oil case

The unloaded and remaining liquid volumes have to add up to 300 ml. However, for 10% oil case there is a volume mismatch recorded in the range of 4-5% of this initial volume. A thin layer of emulsion is seen in between the top oil and bottom turbid water in the liquids, especially at higher surfactant concentrations. The formation of emulsion in the remaining liquid volume is negligible, but it is noticeable in unloaded liquid volume.

4.4.3. *Foam Height and Liquid Unloading, 25% Oil*

Figures 4.16 and 4.17 show the foam height and unloaded liquid height trends with time for the three conducted tests with AOS and 25% oil fraction in the liquid phase (75% water cut). The results are presented with AOS surfactant concentrations of 100, 300, and 500 ppm. Increased foam generation and unloaded liquid heights with increasing surfactant concentrations are still noticeable. However, the graphs show further decreases in foam generation as compared to the cases with 10% oil. The unloaded liquid is also reduced significantly due to the presence of increased oil fraction and reduced foam generation.

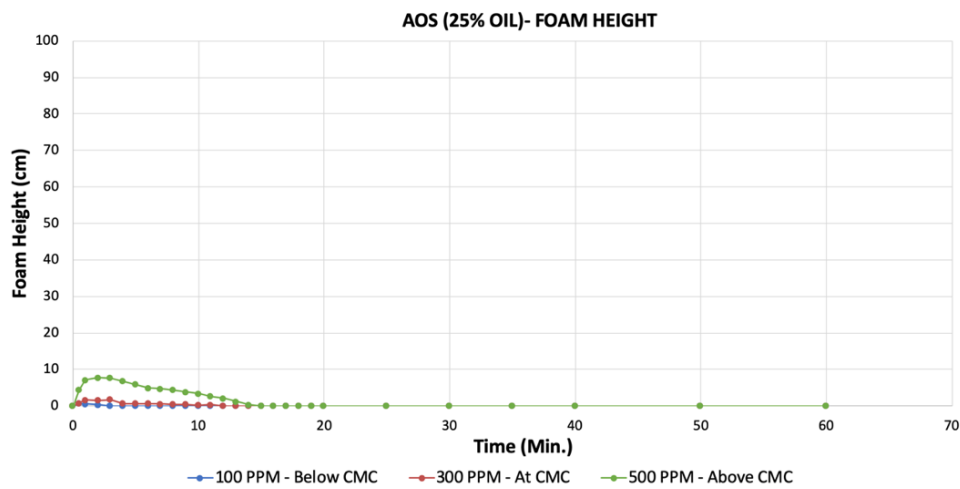

Figure 4.16. Changes in Foam Height with Time for AOS, 25% Oil case

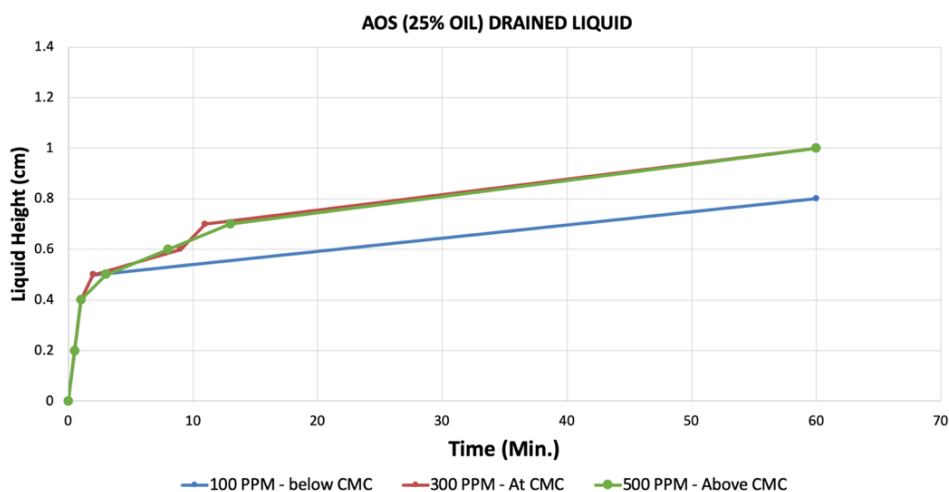

Figure 4.17. Changes in Unloaded Liquid Height with Time for AOS for 25% Oil case

The figures showing the foam height and unloaded height for all the other surfactants are included in the appendix. The decreasing foam generation trends are similar to the cases of AOS as a surfactant. Maximum foam heights for 25% oil cases are summarized in Figure 4.18 for all the surfactants. For lower concentrations, the foam heights obtained are very low and foam is seen dominated by the presence of oil. The thin foam layer seen at the top of the liquid is poorly illustrated as a total foam height. This impacts the foam density and foam quality calculations showing almost zero foam volume for lower concentrations. AOS, Makon, and CTAB still show acceptable foam heights at higher concentrations. With Amphosol foam height is surprisingly observed higher compared to 10% oil case, providing maximum foam height at CMC. Further analysis of foam generation patterns is required to explain this behavior. Also, the commercial surfactant MC 6400029 is providing an acceptable amount of foam despite the 25% oil fraction.

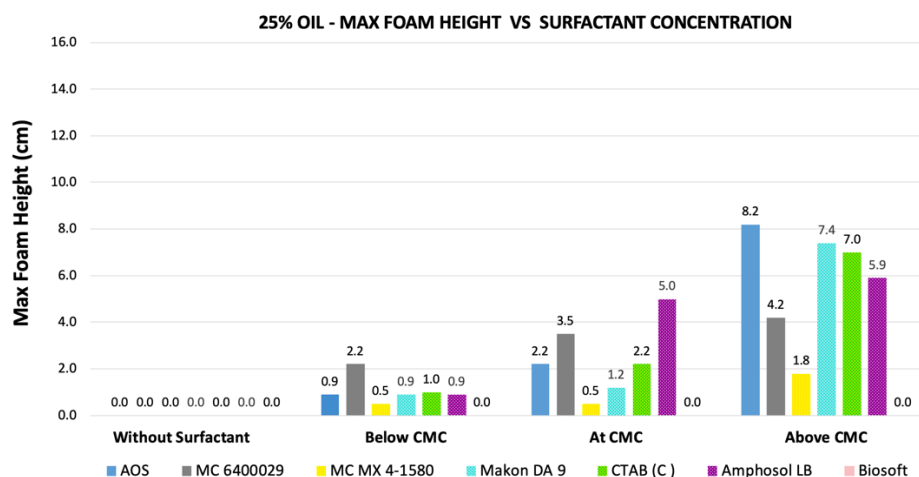

Figure 4.18. Maximum Foam Height for all Surfactant for 25% Oil case

Figure 4.19 shows the unloaded liquid volumes for all surfactant types and concentrations with a 25% oil fraction. All the values are out of 300 ml of initial liquid volumes. Again, no unloading is observed for the cases with no surfactant and with Biosoft as a surfactant. Unloading performances of all surfactant types are reduced compared to 10 % oil cases. However, the unloading efficiencies exceed 50% for almost all cases at and above CMC. This shows that despite the increased oil fractions; foam lift is still beneficial in well deliquification. Makon DA 9, AOS, and CTAB maintain relatively good performances for 25% oil fraction cases, while the performances of commercial surfactants are also acceptable. Amphosol’s performance improves at concentrations above CMC.

Figure 4.20 shows the remaining liquid volumes in the production column for the same cases with 25% oil fraction in the liquid phase. The summation of unloaded and remaining liquid volumes has to add up to 300 ml. For these cases with 25% oil fraction, the maximum volume mismatch observed is up to 6% of initial poured

volume, due to residual liquid in the connecting arm and possible evaporation of the oil.

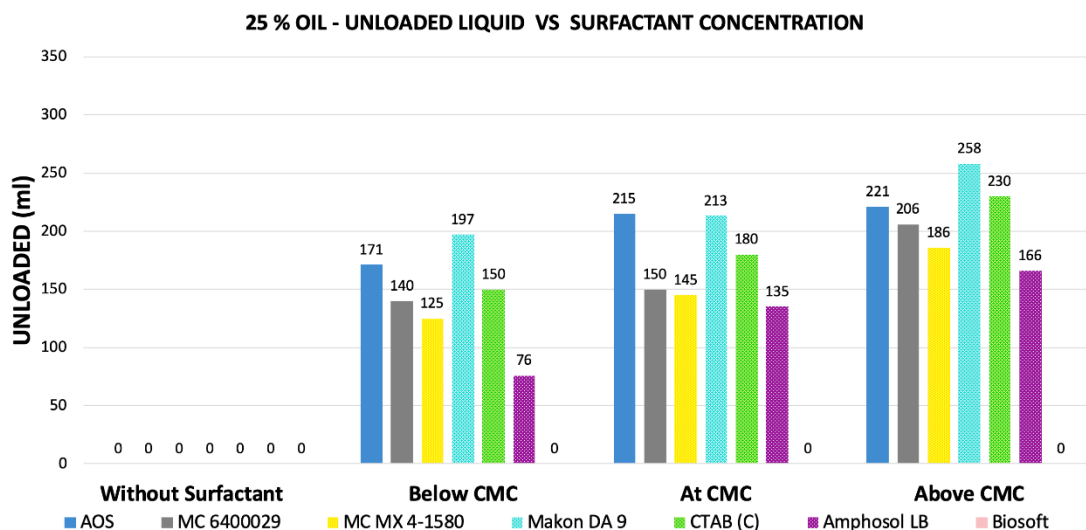

Figure 4.19. Unloaded Liquid Volumes for All Surfactants with 25% Oil Fraction

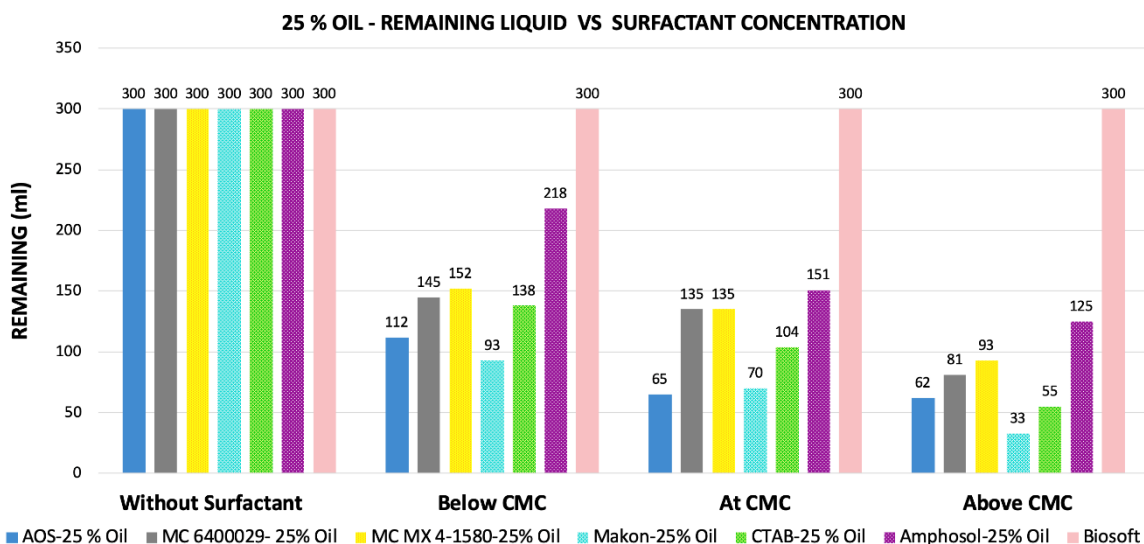

Figure 4.20. Remaining Liquid Volumes for All Surfactants with 25% Oil Fraction

An emulsion layer is seen mostly for higher concentrations in unloaded liquid volume. The water phase is more turbid than 10% oil cases. The formation of emulsion

in the remaining liquid volume is also slightly increased compared to 10% oil cases. Figure 4.21. shows a picture of the emulsion layer at the water phase and the oil-water interface. Also, some figures are added in Appendix A.4 showing the presence of emulsion dominantly for higher concentrations with different surfactants.

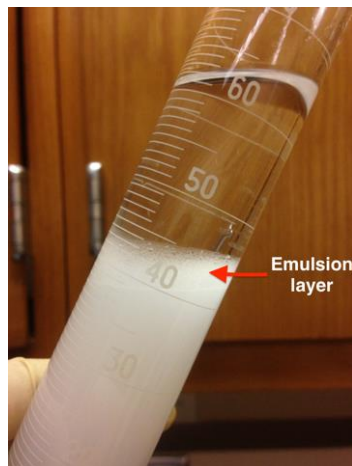

Figure 4.21. Presence of emulsion layer at water oil interface, remaining liquid

4.4.4. Foam Height and Liquid Unloading, 50% Oil

Figures 4.22 and 4.23 show the foam height and unloaded liquid height trends with time for the three conducted tests with AOS, this time with a 50 % oil fraction in the liquid phase (50% water cut). Similarly, the results are presented with surfactant concentrations of 100, 300, and 500 ppm. These cases were selected to show an example of the effects of oil presence on foam generation. The unloaded liquid is reduced significantly due to the presence of 50% oil cut. The foam height is negligible for the cases of at or below CMC concentrations. This diminished foaming has resulted in further reduced volumes of unloaded liquid in all cases. The foam produced by

AOS is still relatively rigid as compared to the commercial surfactants. This was also noticed during the preparation of solutions as shown in Appendix A.11.

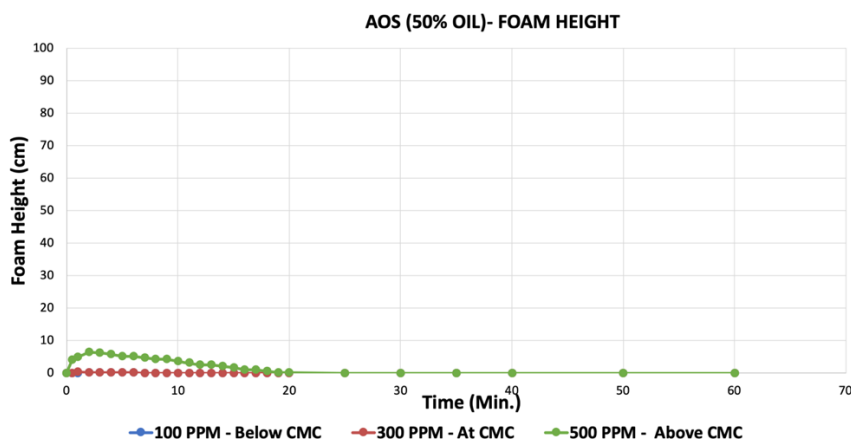

Figure 4.22. Changes in Foam Height with Time for AOS, 50% Oil case

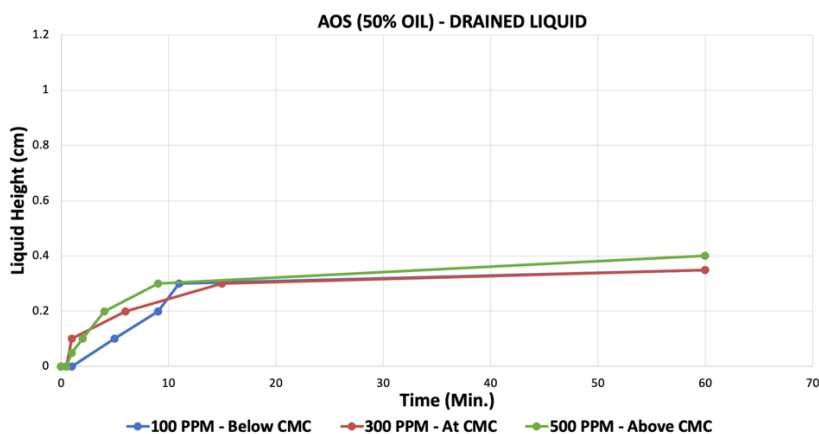

Figure 4.23. Changes in Unloaded Liquid Height for AOS, 50% Oil case

With 50% oil fraction, liquid unloading is delayed for almost all the surfactants, especially at lower concentrations. Maximum foam heights for 50% oil cases are summarized in Figure 4.24 for all the surfactants. Foam heights are almost diminished for all the concentrations. At the end of foam decay, foam was seen embedded in the top oil layer and took longer time to decay, as observed in Figure 4.25 for a case with

50% oil fraction. This phenomenon is seen for other surfactants as well especially at 50% oil case shown in detail in Appendix A.20. In the comparison of surfactants, Biosoft again failed to perform in the presence of oil. Amphosol failed to perform at concentrations below CMC or at CMC. AOS showed some foam embedded in the oil layer. This phenomenon is mostly noticed for higher oil fractions. Overall, most surfactants generate acceptable amounts of foam only at concentrations above CMC.

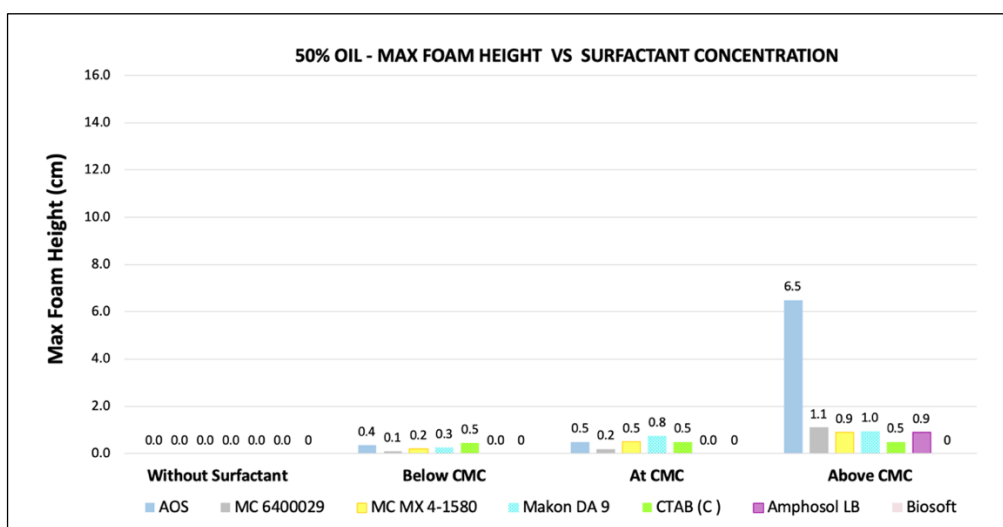

Figure 4.24. Maximum Foam Height for all Surfactants for 50% Oil case



Figure 4.25. Unloaded Liquid, Oil- water interface, 50% Oil case

Figure 4.26 and 4.27 show the unloaded and remaining liquid volumes for all surfactant types and concentrations with 50% oil fraction in the liquid phase. The

CHAPTER 4

unloaded liquid volumes are significantly decreased for this case, showing the dependence of foam lift on fluid water cut. For Amphosol, unloading became completely inefficient. Also, the concentration effects are seemingly maximized, favoring the cases with above CMC concentrations. This is possibly because large fractions of the surfactant are consumed at the oil-water interface, increasing the requirement of concentrations. The commercial surfactants show relative improvements for the above CMC case, becoming the most efficient surfactants. Also, Makon DA 9 is still maintaining acceptable performance, followed by CTAB. Further study of the surfactant chemistry is required to better understand the behavior of different surfactant types. Figure 4.27 shows the remaining liquid volumes in the production column for the same cases with 50% oil fraction in the liquid phase. The summation of unloaded and remaining liquid volumes has to add up to 300 ml. For 50% oil case there is a volume mismatch recorded in the range of 6-7% of initial poured volume.

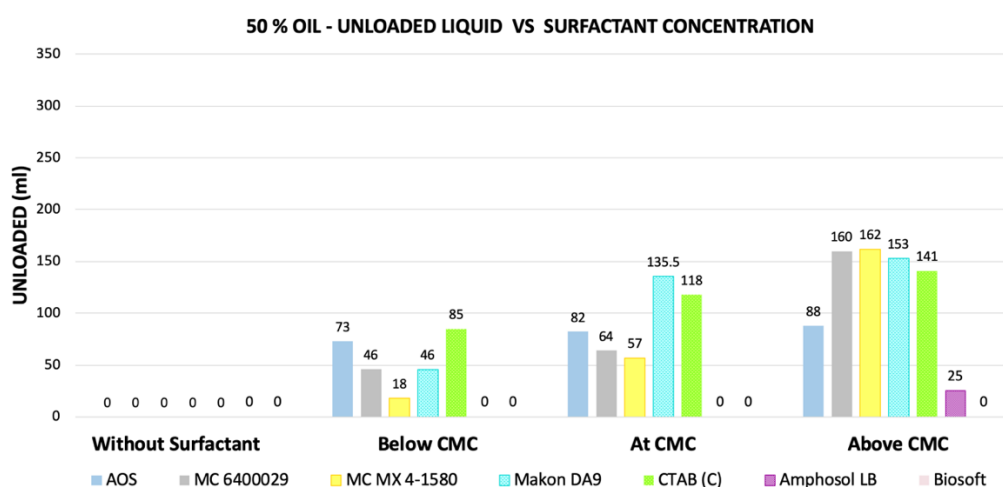

Figure 4.26. Unloaded Liquid Volumes for All Surfactants with 50% Oil Fraction

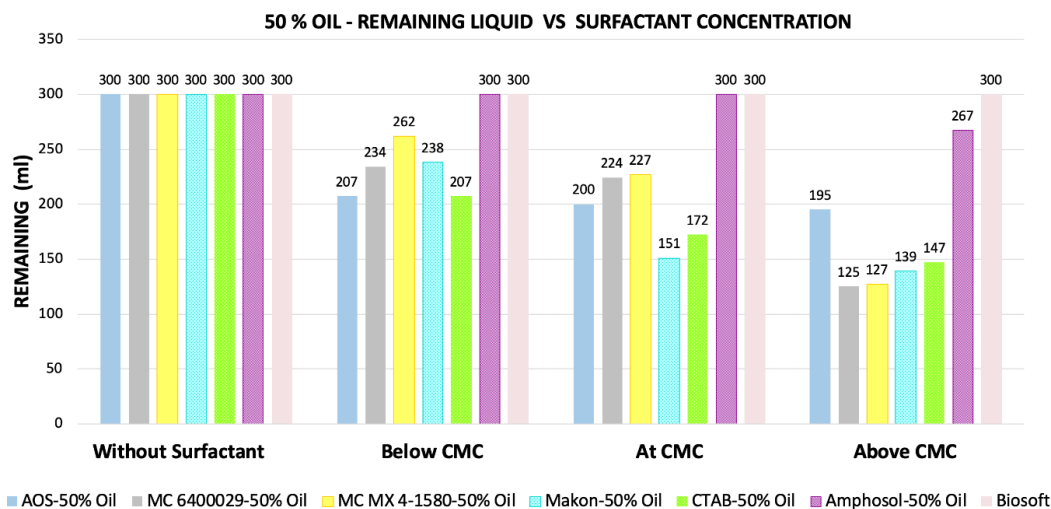

Figure 4.27. Remaining Liquid Volumes for All Surfactants with 50% Oil Fraction

An emulsion is seen for almost all the concentrations with a 50% oil fraction. At higher concentrations, the formation of the emulsion is increased significantly and creates a blockage at the bottom sparger of the production column. The inner surface of the production column and connecting arm are seen deposited with a sticky layer especially at the high range of concentrations for AOS and CTAB. Figure 4.28 shows sample pictures of the unloaded and remaining liquids. The presence of emulsion is dominantly seen in unloaded liquid. The observed emulsion is more viscous and thicker as compared to 25% cases. Commercial surfactants show less emulsion comparatively. Some figures are added in the appendix A.16 to show comparisons of generated emulsions in the cases with 25% and 50% oil fraction. Isopropanol was used frequently to clean the surfaces of equipment and the blockage in the sparger at the production column bottom.

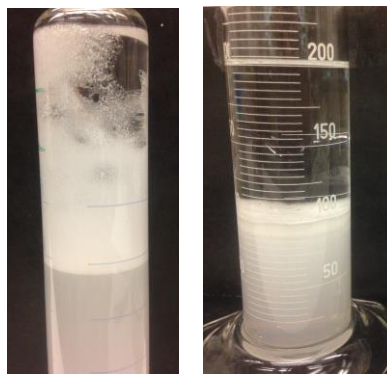

Figure 4.28. Unloaded and Remaining Liquid Volumes for AOS, 50% Oil case

4.4.5. Liquid Unloading Efficiency Summary

A liquid unloading efficiency can be defined considering the initial and final unloaded volumes of liquid to better characterize the performances of surfactants. Equation 4.4 shows the simple definition proposed for this surfactant efficiency ratio,

$$\text{Efficiency Ratio} = \frac{\text{Volume of liquid unloaded}}{\text{Initial volume of liquid}} \quad (4.4)$$

Table 4.4 shows the summary of unloading efficiency ratios for different surfactants, concentrations and oil fractions. Efficiency ratios for all surfactants increase with the increase in concentration. As the oil fraction in liquid increases, the efficiencies for all surfactants go down. So, the unloading efficiencies are maximum for the cases with no oil and above CMC for every surfactant. Under this condition, the efficiency of Makon is maximum (95.3% for above CMC, 100% water case). After Makon, AOS and two commercial surfactants are following. For oil cases, two commercial surfactants have kept up their performance along with Makon. Amphosol and Biosoft show poor performances comparatively.

CHAPTER 4

	AOS			
Case	No Oil	10 % Oil	25% Oil	50 % Oil
Without Surfactant	0.0	0.0	0.0	0.0
Below CMC	77.7	73.3	57.0	24.3
At CMC	89.7	83.3	71.7	27.3
Above CMC	90.0	85.7	73.7	29.3

	Commercial Surfactant 1 (MC 6400029)			
Case	No Oil	10 % Oil	25% Oil	50 % Oil
Without Surfactant	0.0	0.0	0.0	0.0
Below CMC	78.7	60.0	46.7	15.3
At CMC	85.0	61.7	50.0	21.3
Above CMC	85.5	63.3	68.7	53.3

	Commercial Surfactant 2 (MC MX 4-1580)			
Case	No Oil	10 % Oil	25% Oil	50 % Oil
Without Surfactant	0.0	0.0	0.0	0.0
Below CMC	69.3	57.0	41.7	6.0
At CMC	83.7	58.7	48.3	19.0
Above CMC	86.0	58.7	62.0	54.0

	Makon DA 9			
Case	No Oil	10 % Oil	25% Oil	50 % Oil
Without Surfactant	0.0	0.0	0.0	0.0
Below CMC	76.7	66.7	65.7	15.3
At CMC	86.7	74.0	71.0	45.2
Above CMC	95.3	90.0	86.0	51.0

	CTAB (C)			
Case	No Oil	10 % Oil	25% Oil	50 % Oil
Without Surfactant	0.0	0.0	0.0	0.0
Below CMC	77.0	65.3	50.0	28.3
At CMC	84.3	71.7	60.0	39.3
Above CMC	85.7	81.7	76.7	47.0

	Amphosol LB			
Case	No Oil	10 % Oil	25% Oil	50 % Oil
Without Surfactant	0.0	0.0	0.0	0.0
Below CMC	26.0	23.0	25.3	0.0
At CMC	56.0	43.3	45.0	0.0
Above CMC	69.3	53.3	55.3	8.3

Case	Biosoft			
	No Oil	10 % Oil	25% Oil	50 % Oil
Without Surfactant	0.0	0.0	0.0	0.0
Below CMC	2.8	0.0	0.0	0.0
At CMC	10.8	0.0	0.0	0.0
Above CMC	56.3	0.0	0.0	0.0

Table 4.4: Unloading Efficiency Ratios for all the surfactants

4.5. Unloaded and Remaining Liquid, Water Cut Effects

The results obtained in terms of unloaded liquid in the collection column and remaining liquid in the production column are a good indicator of foam lift efficiency. As mentioned, the initial liquid volume in the production column was fixed at 300 ml. Figure 4.29 is included to see the individual surfactant’s performance in terms of liquid unloading at varying water cuts.

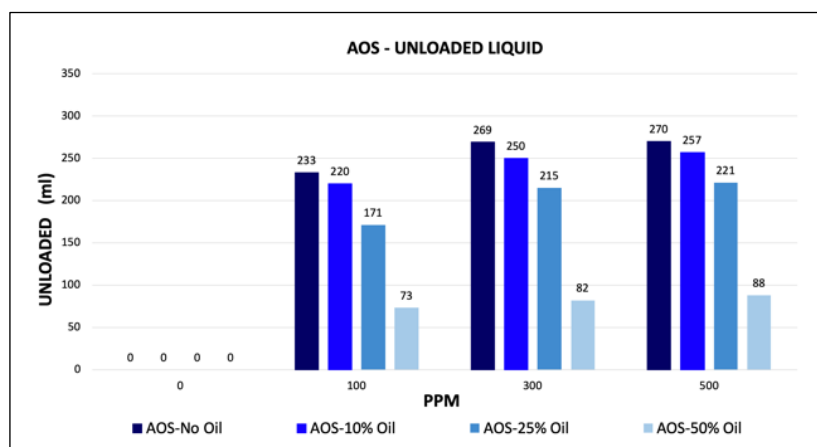

Figure 4.29. Liquid Unloaded for AOS, all water-oil fractions

The results obtained in terms of unloaded liquid in the collection column and remaining liquid in the production column are a good indicator of foam lift efficiency. As mentioned, the initial liquid volume in the production column was fixed at 300 ml. Figure 4.29 is included to see the individual surfactant’s (AOS) performance in terms

CHAPTER 4

of liquid unloading at varying water cuts. As seen in the previous section, the unloaded liquid decreases with the increase in oil fraction due to the reduced foam generation. This reduction in efficiency is most significant as the oil fraction increases from 25% to 50%. This can be because of the generation of continuous oil films within the liquid phase. Appendix A.6 is included for the illustration of loaded and unloaded liquid volumes for all the remaining surfactants.

Figure 4.30 is for unloaded liquid volumes for CTAB without and with a cosolvent. It shows the presence of CTAB helped to improve the unloaded liquid as the solubility of CTAB in water is improved. This improvement is seen almost, for all the cases. CTAB (C) means with cosolvent and CTAB (NC) means without cosolvent. As the performance with cosolvent is better, further tests for CTAB are conducted using cosolvent. Also, the results for other surfactants are included in Appendix A.6

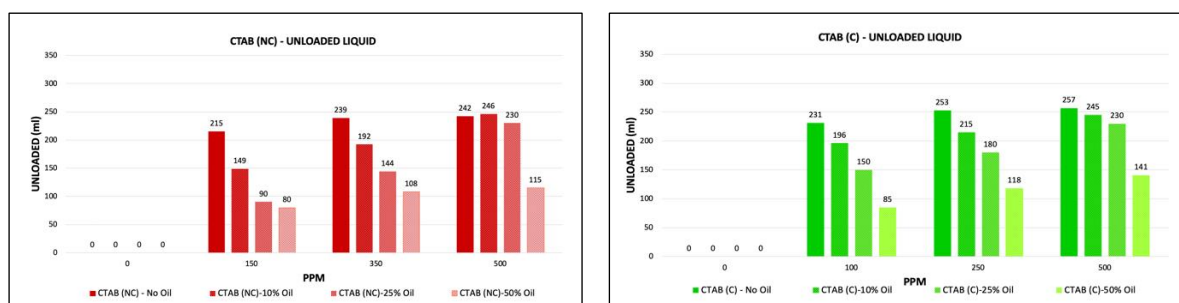

Figure 4.30. Improved Liquid Unloading for CTAB with cosolvent.

The percentage of reduction in a surfactant's foam lift efficiency can be calculated for different water cuts to better characterize various surfactant types. It represents the effect of the presence of oil on liquid unloading and can be estimated using Equation 4.5.

CHAPTER 4

$$\% \text{ reduction} = \frac{\text{Volume unloaded (100\% wc)} - \text{Volume unloaded (90\% wc)}}{\text{Volume unloaded (100\% wc)}} \quad (4.5)$$

Figure 4.31 shows the percentage reduction for AOS. Figures 4.32 – 4.34 are shown for percentage reduction comparison for all the surfactants for different water-oil fractions. Table 4.5 shows this reduction in performances of different surfactants at different water cuts in tabular format. For Biosoft, as there is no unloading for 10% and above oil fractions cases the percentage reduction appears as 100%.

The percentage reduction is maximum for 50% oil cases at below CMC concentrations. It is minimum, for 10 % oil cases for below CMC concentrations. The percentage reduction is seen decreased, with increased concentrations. For 10% oil cases CTAB, AOS, Makon showed minimum percentage reduction for above CMC. Both the commercial surfactants showed a minimum percentage reduction for 50% case above CMC case.

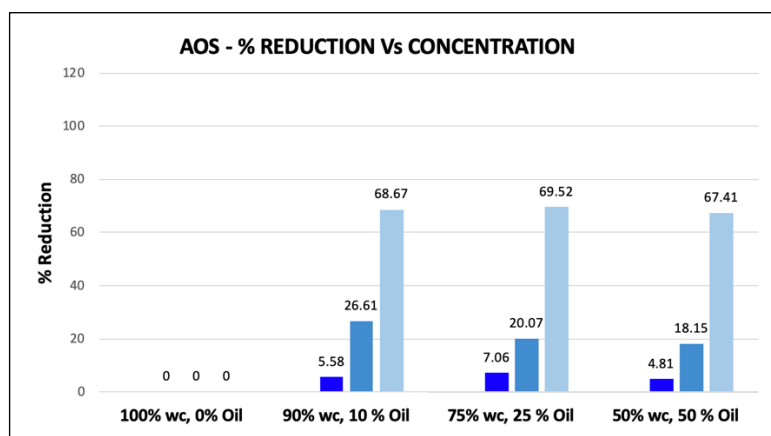

Figure 4.31. Percentage Reduction for AOS

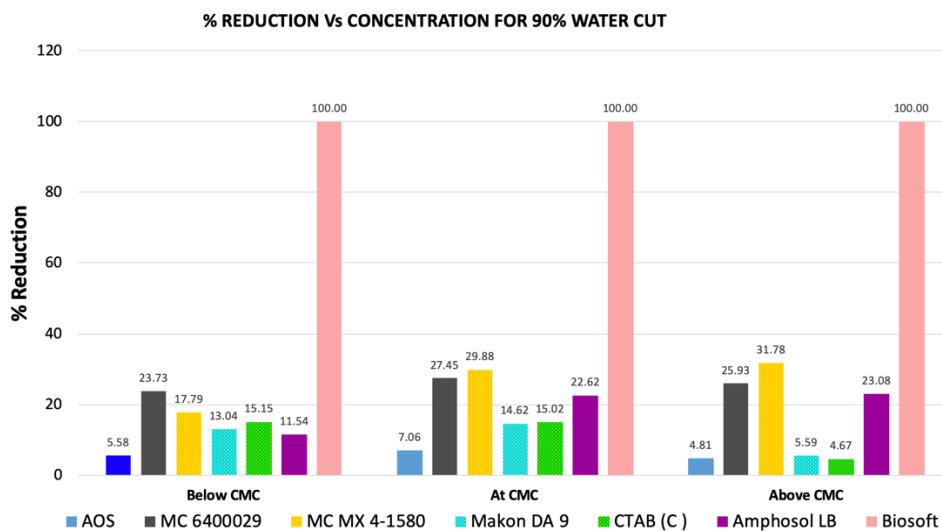

Figure 4.32. Percentage Reduction for all surfactants for 10% oil case

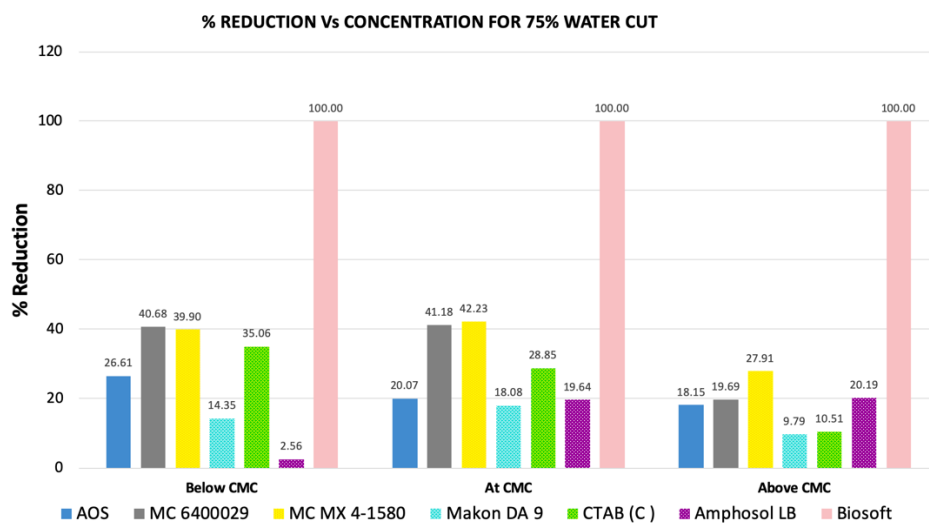

Figure 4.33. Percentage Reduction for all surfactants for 25% oil case

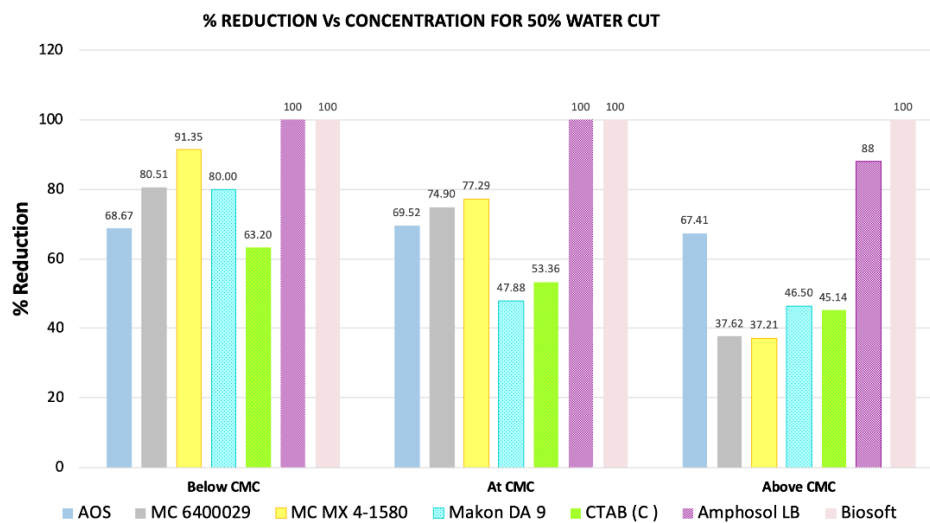

Figure 4.34. Percentage Reduction for all surfactants for 50% oil case

4.6. Foam Quality

The foam quality is the ratio of gas volume to foam volume (gas + liquid), representing the volume percentage of gas within the foam [10]. In this study foam height and liquid height are used for the calculation of foam quality Equation 4.6 shows the general formula used to estimate the foam quality.

$$\text{Foam Quality} = \frac{\text{Max foam Height (cm)} - \text{Final Height of liq (cm)}}{\text{Max foam Height (cm)}} \times 100 \quad (4.6)$$

Figures 4.35 to 4.38s show the resulting foam qualities for all the tests conducted with varying surfactant types and concentrations and with 0%, 10%, 25% and 50% oil fraction, respectively. The foam quality determines the gas and liquid fractions in the foam. The figures show that the gas fraction is highest for 100% water case. Foam quality is also a function of surfactant concentration. It increases with concentration and reaches a maximum for above CMC concentrations. After Biosoft, Makon shows

the lowest foam quality. Considering the high liquid unloading values for Makon, this means for Makon foam gas fraction is relatively low and the liquid fraction is relatively high.

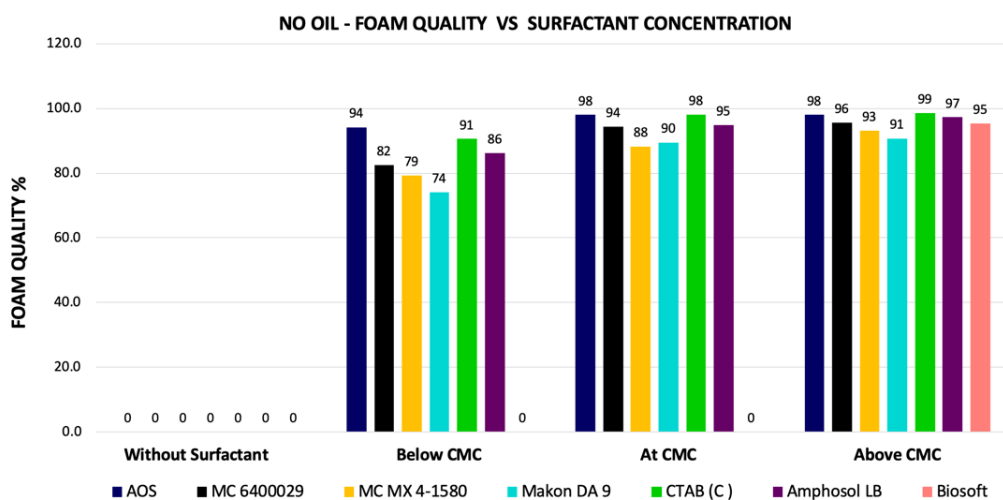

Figure 4.35. Foam Quality for all the surfactants, for No Oil case

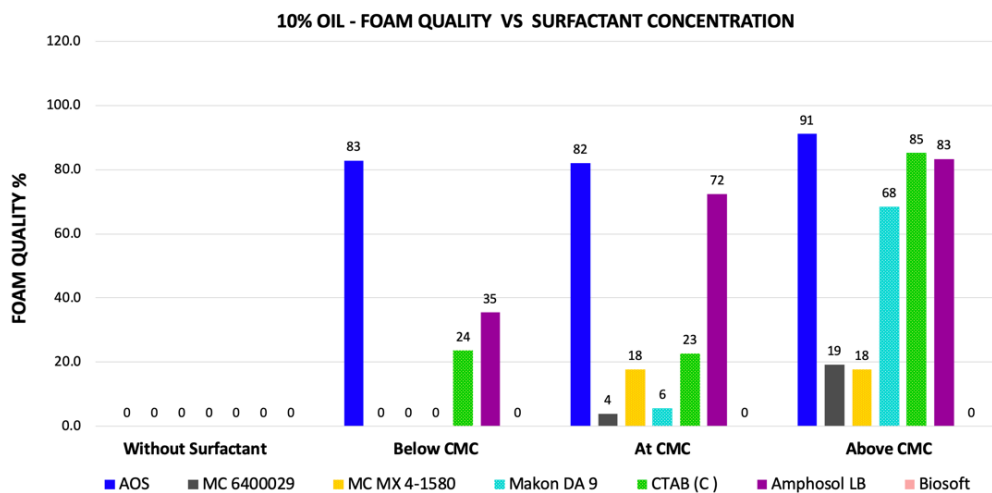

Figure 4.36. Foam Quality for all the surfactants, for 10% Oil case

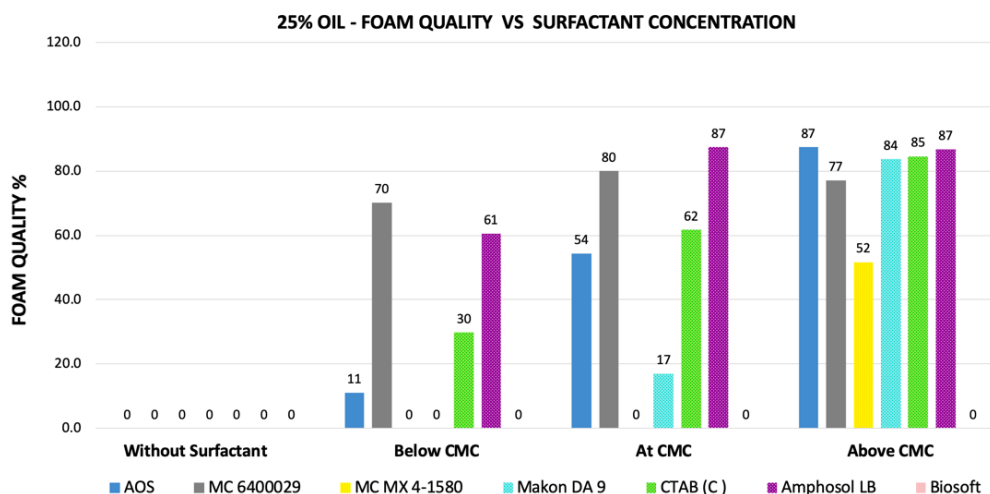

Figure 4.37. Foam Quality for all the surfactants, for 25% Oil case

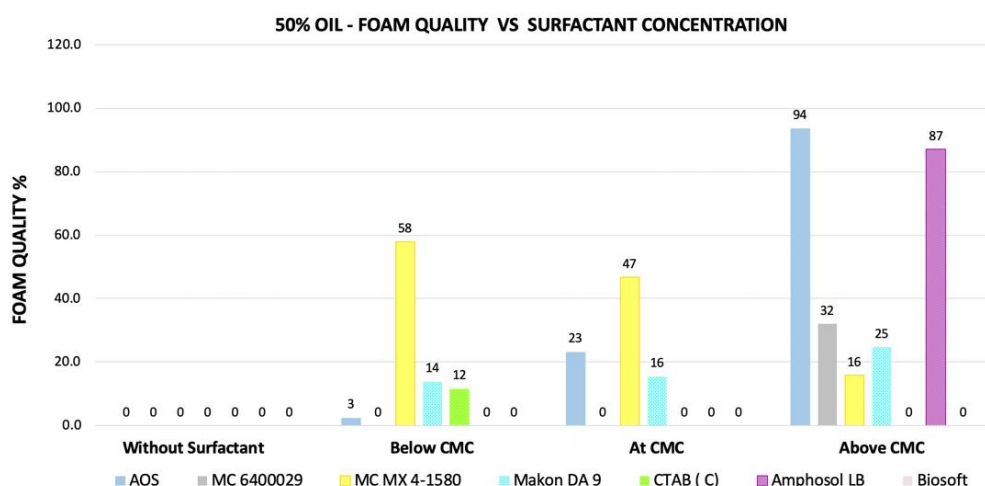

Figure 4.38. Foam Quality for all the surfactants, for 50% Oil case

As the oil is introduced to the system, the foam quality is affected. AOS still shows a high foam quality for a 10% oil cut. For lower concentrations, the foam heights obtained are very low and foam is seen destroyed due to increased oil fraction. The thin foam layer seen at the top of the liquid is poorly illustrated as a total foam height. This impacts the foam quality calculations showing almost zero foam volume for lower concentrations. AOS foam is observed viscous and rigid to break. Amphosol

and CTAB above CMC concentrations also show high foam qualities following AOS. The foam qualities of Amphosol and the commercial surfactants increase for the 25% oil fraction cases. For 50% oil cut the foam quality is reduced significantly due to the presence of large amounts of oil in the foam structure. The patterns observed in the foam quality follow the foam density and liquid unloaded results as well. As the foam quality increases the foam density decreases and liquid unloaded also increases.

4.7. Foam Density

Foam density is calculated by considering maximum foam height to calculate the foam volume and the mass of liquid after complete decay of foam in the collection column. The foam density is the ratio of this unloaded liquid mass to maximum foam volume. Foam density can be related to the water content or wetness of the foam. Higher foam density means a higher liquid carrying capacity for the foam. Equation 4.7 shows the formula used to calculate foam density.

$$\rho_f = m_u / V_f \quad (4.7)$$

where ρ_f is foam density in kg/m^3 , m_u is the mass of unloaded liquid obtained after complete decay of foam in kg, and V_f is the volume of foam in m^3 . Figures 4.39 to 4.42 show the resulting foam densities for all the tests conducted with varying surfactant types and concentrations and with 0%, 10%, 25% and 50% oil fraction, respectively.

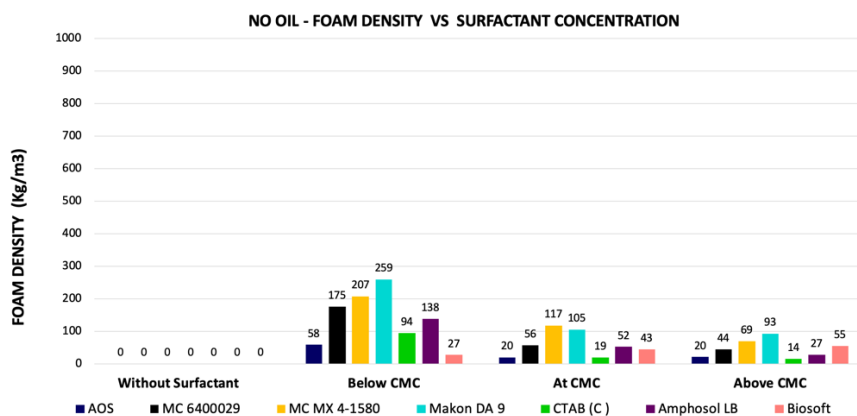

Figure 4.39. Foam Density for all surfactants for no Oil case

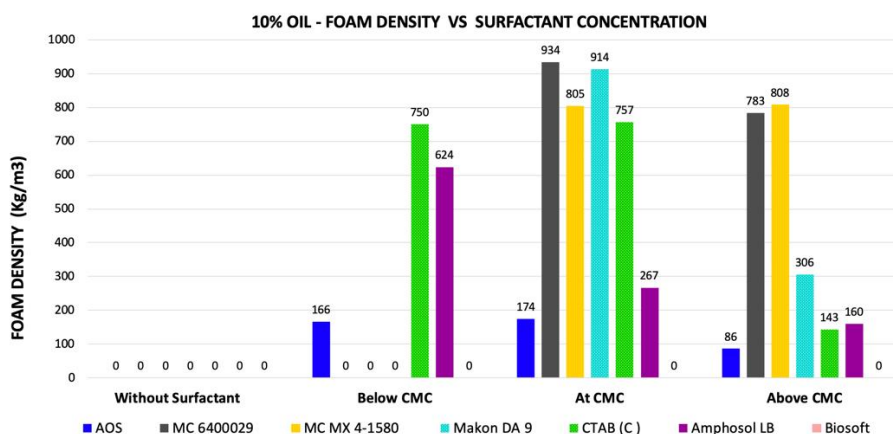

Figure 4.40. Foam Density for all surfactants for 10% Oil case

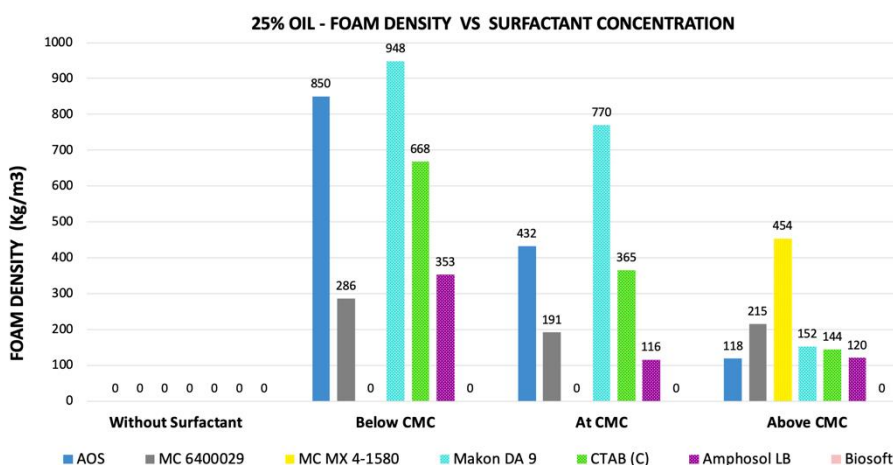

Figure 4.41. Foam Density for all surfactants for 25% Oil case

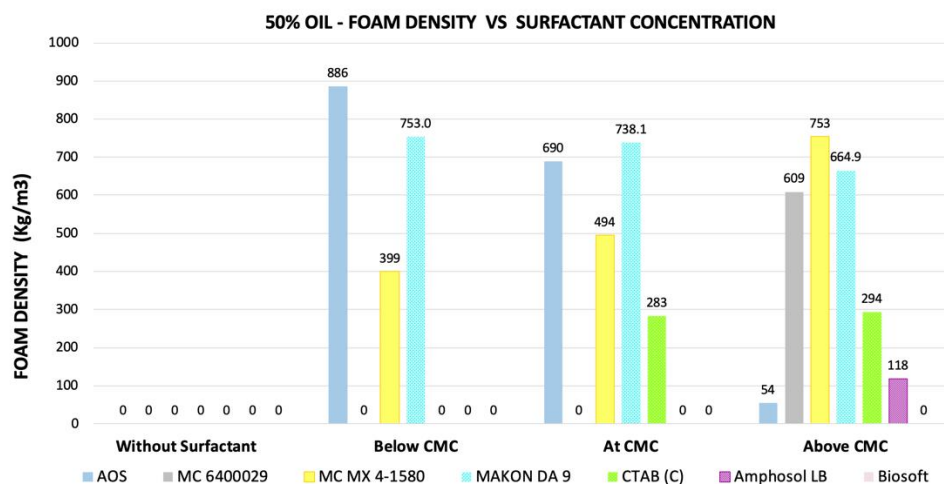

Figure 4.42. Foam Density for all surfactants for 50% Oil case

Foam density for no oil case is much lower than the oil cases. This can be explained by high foam volume as compared to oil cases. Makon and commercial surfactant 2 show relatively high foam density for no oil case. In general, foam density decreases as the surfactant concentration increases. This trend is because of the increased foam generation and is followed for all the water cuts and most cases.

For oil cases the texture of the foam is oily, and foam density is expected to be higher. The foam quantity is lower, and the foam structure is almost diminished for higher oil fractions. For lower concentrations, the foam lasts less than a minute. In those cases, the foam quality is considered as zero, and density is not reported. For higher oil cases the unloaded liquid quantity is reduced as compared to no oil cases and hence foam density is seen increased. The visual observations and density calculations for oil cases have higher uncertainties as the foam heights are small and foam decays quickly.

Recording the readings at smaller scale will be necessary to analyze the behavior more accurately.

4.8. Foam Half-Life

Foam half-life is the time required for the foam to decay to half of its initial or maximum height. Foam stability is measured by foam half-life. If the foam half-life is higher the foam is more stable. Stability of foam is beneficial in terms of deliquification as more stable foam can withstand a longer time and unload more liquid. However, a very long foam half-life can be troublesome considering the need to break the foam in surface facilities. Overall, it is desired to have more foam generated that is stable while producing but breaks quickly as the agitation is removed. Figures 4.43 to 4.46 show the resulting foam half-lives for all the tests conducted with varying surfactant types and concentrations and with 0%, 10%, 25% and 50% oil fraction, respectively.

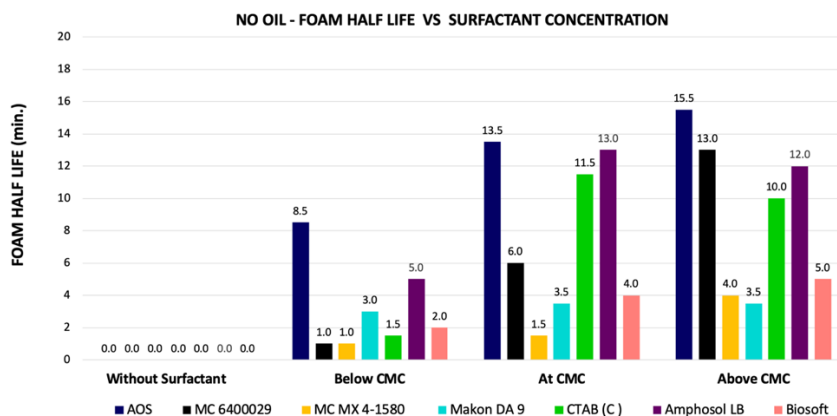

Figure 4.43. Foam half-life for all the surfactants for No Oil case

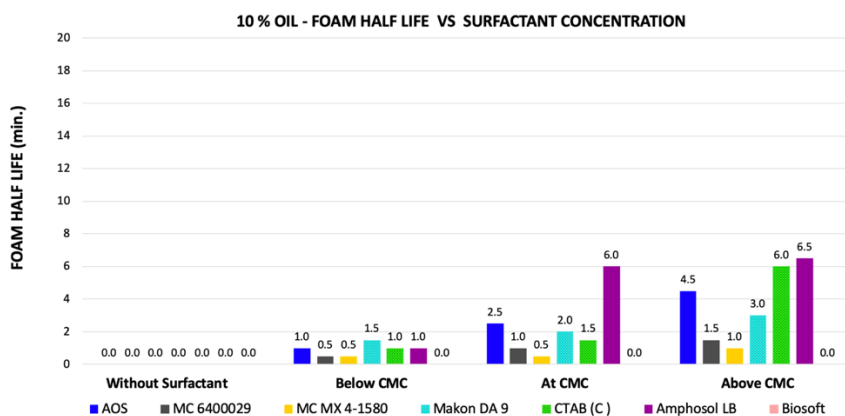

Figure 4.44. Foam half-life for all the surfactants for 10% Oil case

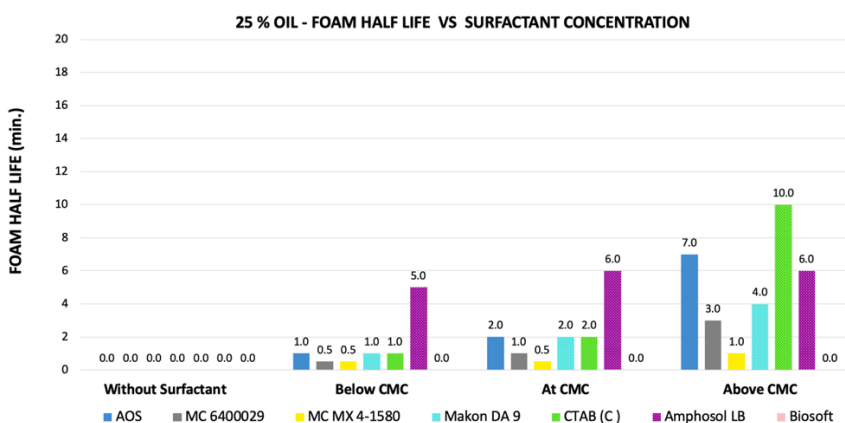

Figure 4.45. Foam half-life for all the surfactants for 25% Oil case

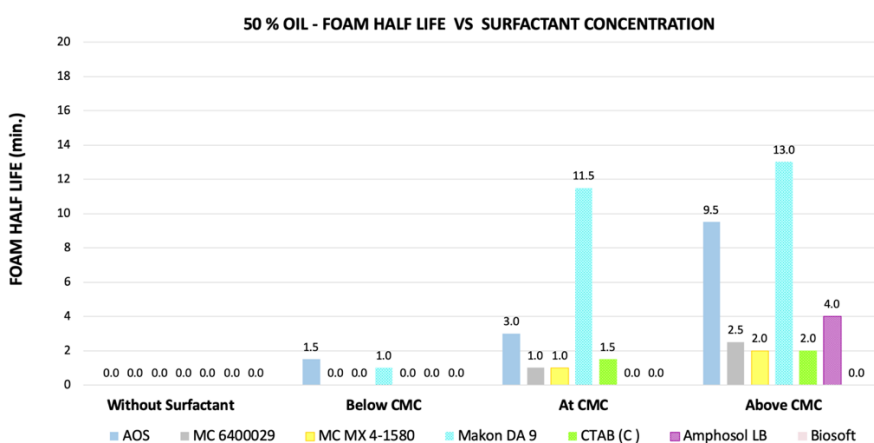

Figure 4.46. Foam half-life for all the surfactants for 50% Oil case

CHAPTER 4

In general foam half-life or foam, stability increases with an increase in concentration up to CMC. Above CMC the concentration effect on foam half-life is reduced or becomes insignificant [7]. The cases with AOS and 100% water cut are showing maximum foam half-lives for all the concentrations. Foam of AOS is rigid and decays slower. Following AOS, Amphosol shows a high foam half-life. CTAB is also showing a high foam half-life at CMC and above CMC concentrations. The above figures show that the presence of oil impacts the foam stability for all the surfactants. Amphosol and CTAB show sustained foam half-life for 10% oil case for above CMC concentrations. In terms of liquid unloading, it is good to have a stable foam, which decays quickly once the unloading is done. Commercial surfactants are better in this case as they have relatively good unloading and smaller half-life. For higher oil cases the foam is seen destroyed a lot, especially at low surfactant concentration cases. Many times, the foam height recorded is a poor representation of total foam height as a very thin layer of foam is seen floating at the top of the liquid. For higher concentrations, the smaller quantity foam is seen embedded in the top oil layer. This increases the liquid fraction around the bubble films making foam decay slower as seen in above Figure 4.46.

The presence of cosolvent (isopropanol) also affects foam decay. In Figure 4.47, the foam half-life for CTAB is compared between the cases with a cosolvent (C) and without it (NC). With cosolvent, the foam seems to collapse faster than without cosolvent. This effect seems to be consistent for all the cases with varying concentrations.

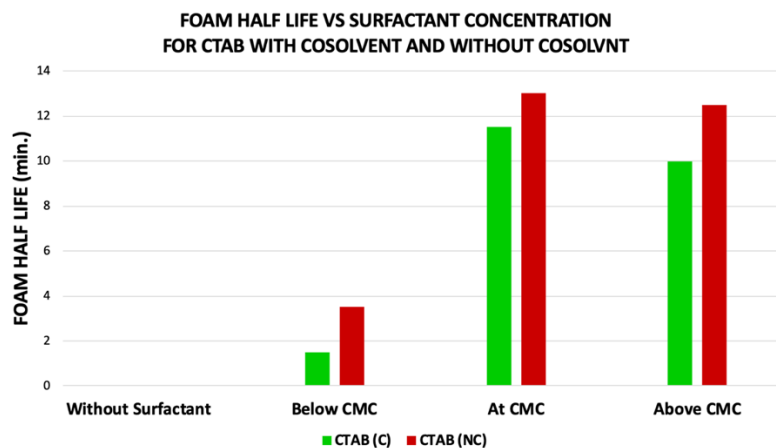

Figure 4.47. Foam half-life comparison for CTAB with cosolvent and without cosolvent

4.9. High Temperature Tests

The main objective of high-temperature tests is to evaluate the performance of surfactants under a more realistic scenario of a producing gas well. It is a common belief that the foaming efficiency gets deteriorated under the high-temperature conditions of the producing wellbores. In this study, high-temperature tests were carried out for a selected number of conditions to compare with previously presented lab-temperature tests. The tests are limited to one concentration, which is at CMC. Also, the tests are conducted only for 100% water cut and 75% water cut (i.e. 25% oil cut) for each surfactant.

4.9.1. Foam Height and Liquid Unloading, 50 °C, No Oil

Figures 4.48 and 4.49 illustrate the comparison between the foam and liquid height at room temperature i.e. 22 °C and at elevated temperature i.e. 50 °C. The foam height

and unloaded liquid height are presented for AOS as a surfactant, at CMC, and with 100% water cut.

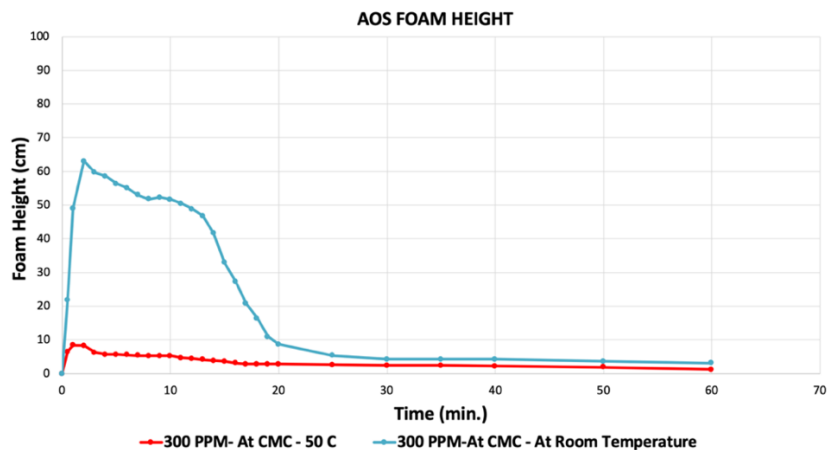

Figure 4.48. Comparison Foam Height, AOS for 100% water case, at two temperatures

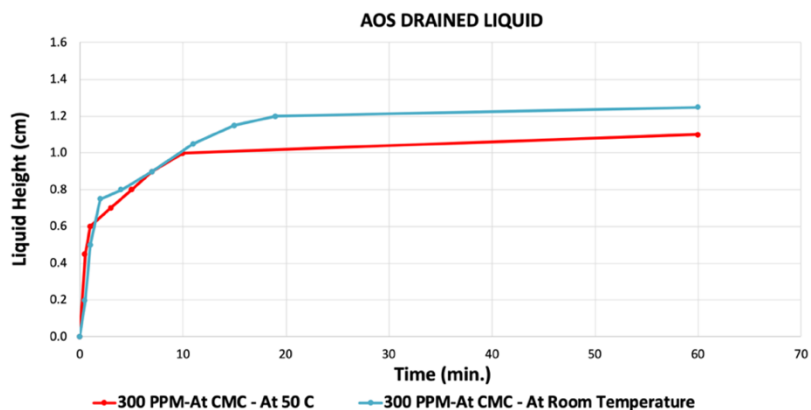

Figure 4.49. Comparison Liquid Height, AOS for 100% water case, at two temperatures

The results show that the unloaded liquid volume is reduced at 50 °C as compared to room temperature for AOS. The foam height is also impacted significantly. At high temperatures, the efficiency of AOS seems to reduce. The figures for all the remaining surfactants with 100% water cut are shown in the appendix A.8.

CHAPTER 4

As the solubility of CTAB is improved due to the presence of isopropanol as a cosolvent, the foamability and hence the liquid unloading is improved. At high temperature, the solubility of CTAB increases and hence the unloaded liquid at 50 °C and at room temperature are very close. The presence of isopropanol has little effect at increased temperature. Figure 4.50 shows the foam height and unloaded liquid height plots for CTAB with cosolvent (C) and without cosolvent (NC). The plots include the cases with room temperature and elevated temperature.

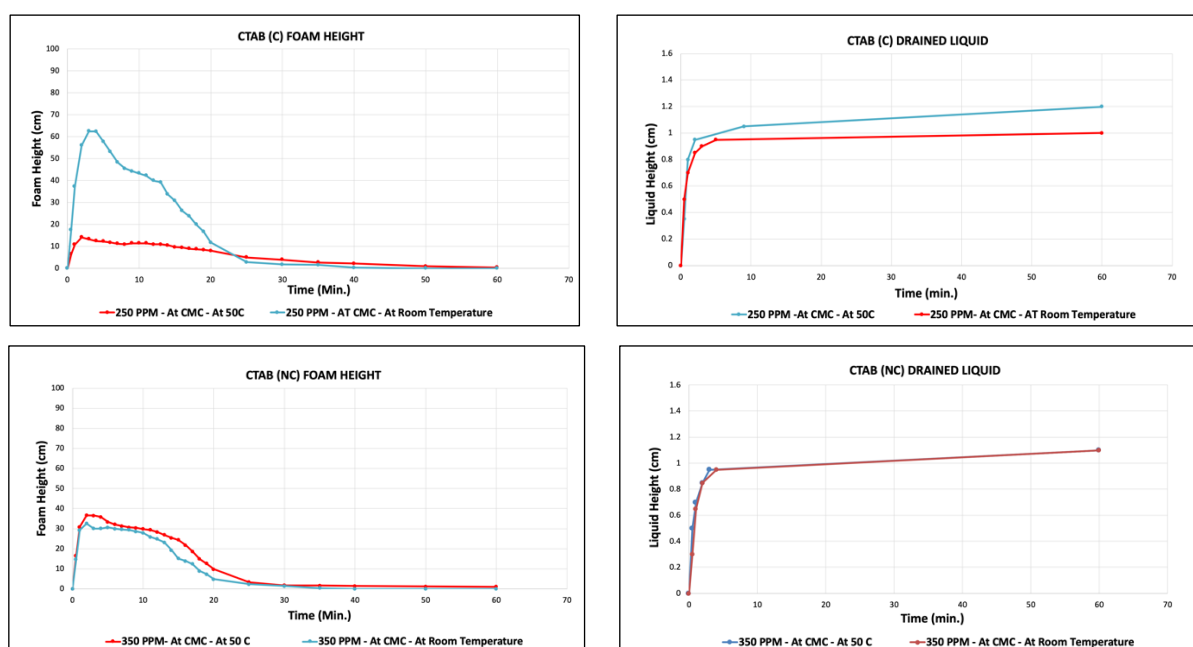

Figure 4.50. Foam and Unloaded Liquid Height, 50 °C, CTAB(C) and CTAB(NC), No Oil

Figure 4.51 shows the comparison for maximum foam height at room temperature and 50°C, at CMC, for no oil case. The foam height for AOS and CTAB is impacted at high temperature. Amphosol and Makon are showing increases in foam height, with Amphosol generating the maximum height at high temperature. Commercial surfactants are also showing minimal drops in foam height with temperature.

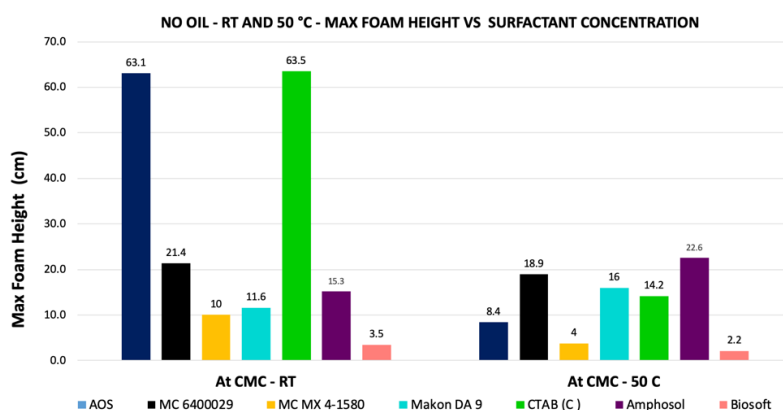

Figure 4.51. Comparison of maximum foam height at RT and 50 °C, no oil

Figure 4.52 shows the comparison of foam half-life at room temperature and 50°C, at CMC, for 100% water case. In the measurement of half-life, it was observed that due to evaporation the produced foam is dry. Foam took relatively more time to break, considering the initial heights obtained for high temperature. The half-life values at high-temperature cases are increased for CTAB, Commercial surfactant 2 and Biosoft. The reason is again dry foam with less water in its bubble structure. Water evaporated along with the draining process making foam dry. The half-life is almost the same for Amphosol, and it reduces for others at high temperature.

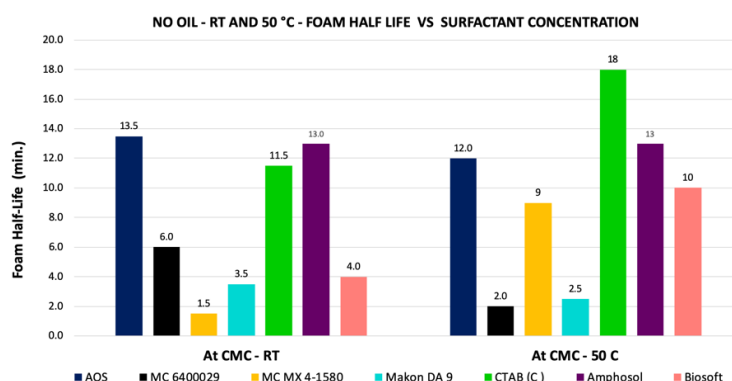

Figure 4.52. Comparison of Foam Half-Life at RT and 50 °C at 100% water

Figure 4.53 shows the comparison of foam quality at room temperature and 50°C, at CMC, for 100% water case. Foam qualities are mostly in the same range as compared to room temperature except for commercial surfactant 2 and AOS. This shows that the gas fraction in the foam structure is almost the same, although the foam heights are reduced at high temperature.

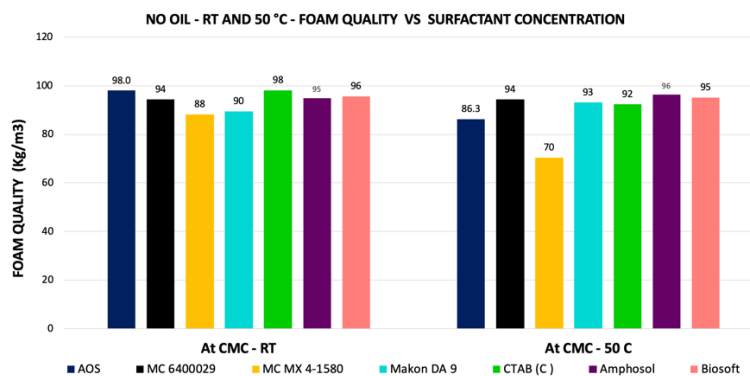

Figure 4.53. Comparison of Foam Quality at RT and 50 °C at 100% water

Figure 4.54 shows the comparison of foam density at room temperature and 50°C, at CMC, for 100% water case. Foam density is slightly increased compared to room temperature. AOS and commercial surfactant 2 are showing large increases in foam density because of the reduced foam quality.

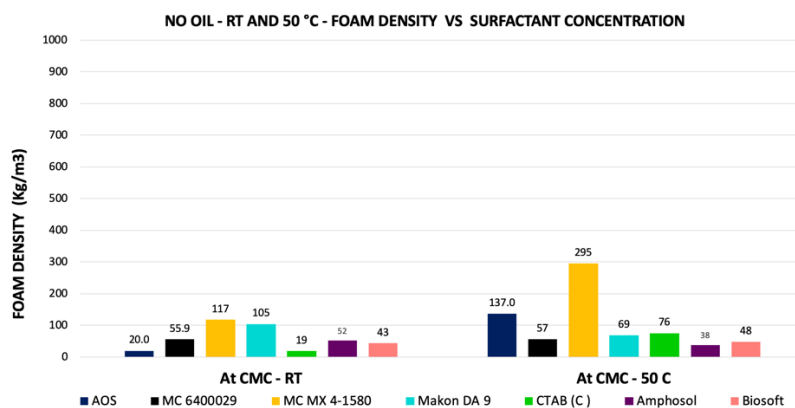

Figure 4.54. Comparison of Foam Density at RT and 50 °C at 100% water

4.9.2. Foam Height and Liquid Unloading, 50 °C, 25% Oil

Figures 4.55 and 4.56 illustrate the foam and liquid heights at room temperature (22 °C) and elevated temperature (50 °C). The foam height and unloaded liquid height are presented for AOS as a surfactant, at CMC, and 25% oil case. It is observed that foam height is almost fully diminished. At 50 °C foam height is even lower than room temperature. Final unloaded liquid height is also reduced in comparison with room temperature, despite initially higher values because of foam decay.

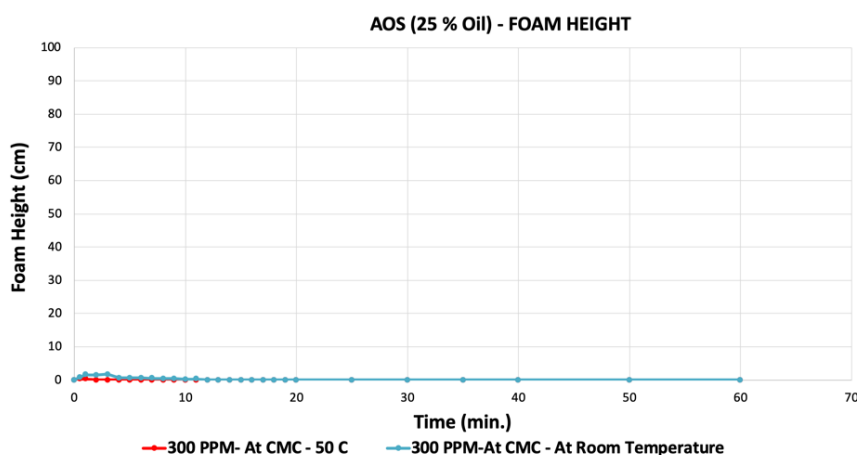

Figure 4.55. Comparison Foam Height, AOS for 25% Oil case, at two temperatures

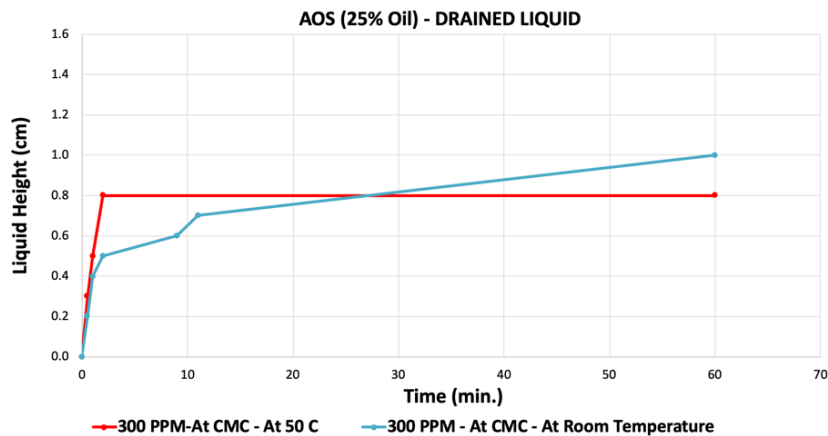

Figure 4.56. Comparison Liquid Height, AOS for 25% Oil case, at two temperatures

Figure 4.57 shows the maximum foam height at room temperature and 50°C, for all surfactants at CMC with a 25% oil fraction. As described in room temperature cases in section 4.2.2, due to the presence of oil the foam heights of all the surfactants are noticeably reduced. Furthermore, at high temperature, the foam generation is clearly reduced. Foam is seen as a thin layer that is hardly detected in visual observations, recorded as zero foam height values. The uncertainties in foam height measurement are high, and therefore the calculation of foam density and foam quality is not possible for these cases.

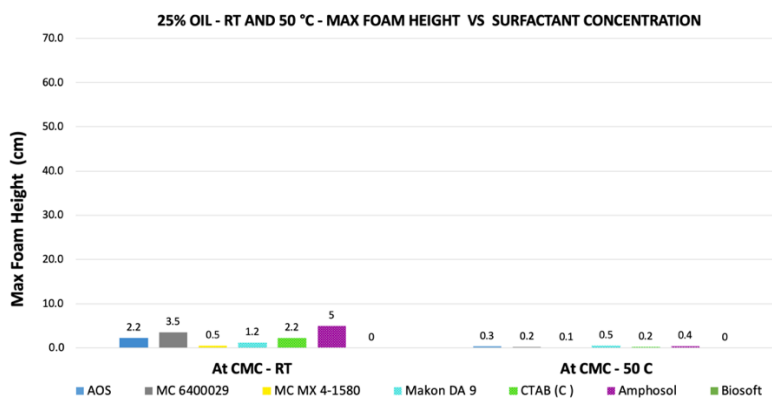

Figure 4.57. Comparison of max foam height at RT and 50 °C at 25% Oil case

Figure 4.58 shows the foam half-life at room temperature and 50°C, for all surfactants at CMC with a 25% oil fraction. As discussed earlier, foam heights for these cases are difficult to measure and visually observe. Foam half-life is also measured approximately. Due to increased temperature, the foam decays faster. Some of the foam is embedded in the oil layer, and it hence lasts slightly longer. This creates a complex structure in oil-water-air interfaces that is a mixture of foam and emulsion. Amphosol’s foam stays longer compared to other surfactants.

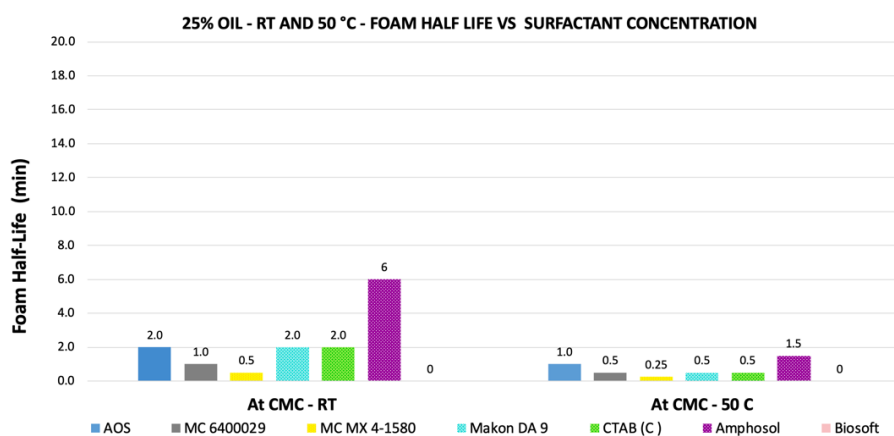

Figure 4.58. Comparison of foam half-life at RT and 50 °C at 25% Oil case

As mentioned earlier, the foam breaks faster due to the presence of oil and increased temperature. Hence the foam quality and foam density values are considered zero for all the high-temperature cases with very small foam amounts.

4.9.3. Liquid Unloading Efficiency at Elevated Temperatures

Figures 4.59 and 4.60 show the unloaded liquid volume comparisons between room temperature and 50 °C for all the surfactants at CMC, with 0% and 25% oil fractions, respectively. Liquid unloading at higher temperature is following a similar trend as

that of room temperature tests for all the surfactants. However, unloading is slightly reduced for almost all the surfactants except Amphosol with temperature. This improved performance of Amphosol is seen for 25% oil case as well, as compared to room temperature. Makon and CTAB also show good performances. AOS and commercial surfactants show drops in liquid unloading at 50 °C, for 25% oil case. For high temperature liquid unloading tests, more evaporation losses were observed compared to room temperature tests during the experiments. On average 7% and in some cases up to 10% of the initial poured volume was evaporated. The emulsion generation was also lower compared to room temperature cases.

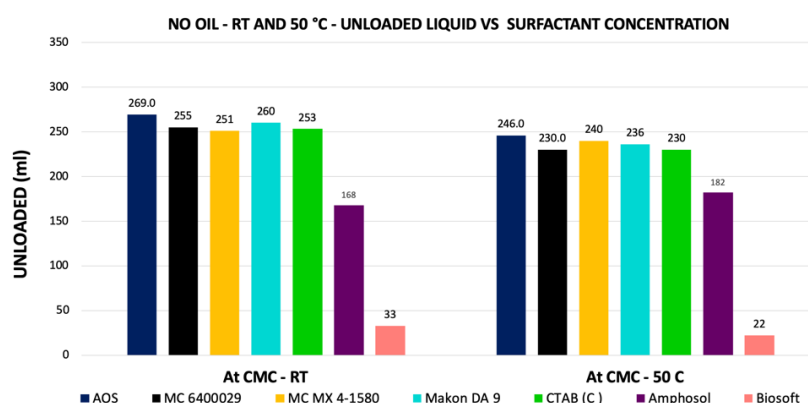

Figure 4.59. Unloaded liquid comparison- No oil case - at Room Temperature and 50 °C

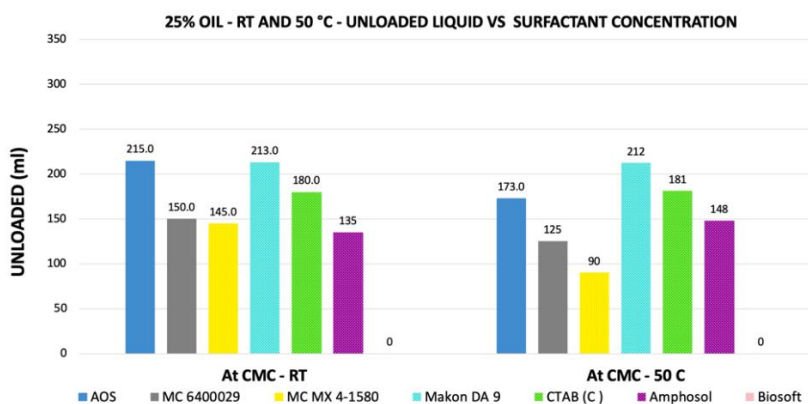

Figure 4.60. Unloaded liquid volume comparison - 25% oil- Room Temperature and 50 °C

4.10. General Experimental Observations

Surfactants like Biosoft are observed to reduce the surface tension, but they do not foam well. They don't have good foamability and foam stability characteristics. Biosoft forms a gel once added to water, affecting its solubility, refer to Figure A.19. During the static and dynamic surface tension experiments, it was observed that making a dissolved solution of Biosoft used to take approximately 20-25 minutes. Stirring the solution was also not effective. Some surfactants due to their extended long tail structure show the tendency of the formation of gels when added in water [26]. The addition of isopropanol was tried with Biosoft. The solubility was improved noticeably with isopropanol but its foamability was affected negatively. Biosoft is the lowest performing surfactant among the selected surfactants.

The solubility of CTAB in the water at room temperature is very limited, i.e. 3g/L at 20°C. The purchased CTAB is >99% pure and is in the form of white powder. The prepared CTAB surfactant has a concentration of 40% by weight in deionized water. The barely soluble CTAB precipitates in the 40% active mixture with water. The cosolvent 'Isopropanol' is used for CTAB to make it easily soluble in water, which is helpful and shows improvement in results. By adding Isopropanol, CTAB is easy to handle during experiments. The prepared mixture of CTAB (C), is with 30% isopropanol in the mixture, hence the prepared mixture contains 40% CTAB + 30% Isopropanol + 30% Water. Refer to Figures A.17 and A.18.

CHAPTER 4

Isopropanol is an alcohol with a water-loving group miscible in water and a hydrocarbon group miscible in oil. As a result, it makes the surfactant immiscible homogeneously miscible in water and oil. However, it works as an antifoaming agent as well. Presence of isopropanol molecules at the air-water interface reduces the foam strength and accelerates the foam decay. The presence of isopropanol reduces the foamability of surfactant and its usage needed to be limited and controlled. The utilization of cosolvent isopropanol should be done with care. While preparing above mentioned CTAB mixtures, trials were made starting with 40% CTAB + 10% isopropanol + 50% water, then 40% CTAB + 20% isopropanol + 40% water, and finally 40% CTAB + 30% Isopropanol + 30% Water. The first two trials (with 10% and 20% isopropanol) did not provide good mixtures to handle. The mixtures were too viscous to handle by laboratory pipette. The range of 25-30% isopropanol was seen as a proper range for making mixtures of CTAB with cosolvent.

In tests with oil, it is observed that the remaining liquid in the production column is relatively clearer and with less emulsion than the unloaded liquid. Unloaded liquid goes through more agitation compared to the remaining one. Hence the unloaded liquid is more turbid with gels and emulsions. In the unloaded liquid, the type of emulsion observed is water in oil (W/O), as the emulsion phase is floating on top of the oil phase. Oil may also be present as a dispersed phase in water, giving it a turbid appearance. In some cases, the emulsion layer was seen in between the oil and water.

CHAPTER 4

For cases with higher oil fraction, especially for 25% and 50 % oil cases, the formation of emulsions and/or gels is clear. The emulsion creates additional difficulties in lifting the liquid. It also blocks the bottom sparger openings and makes difficult to get removed.

Conducting the static and dynamic surface tension tests for CTAB was challenging. Static surface tension test graphs were unsteady and oscillating. Also, the liquid unloading tests were difficult at higher concentrations at room temperature due to its solubility issues. CTAB remained attached to production column walls for a long time and cleaning it was very difficult using just water.

Makon is observed having a strong irritating smell at higher concentrations and at higher temperatures.

CHAPTER 5: CONCLUSIONS AND RECOMMENDATIONS

5.1. Conclusion

Several sets of laboratory-scaled experiments were conducted to investigate the efficiency of surfactants in well deliquification in presence of oil. Various surfactant types were tested in the process. It was observed that the type of foam produced for every surfactant is different. The quantity of foam, the density of foam, and bubble size also vary depending on the surfactant, concentration, and oil fraction. Some of the main conclusions of the work are:

- The presence of oil reduces the foamability of all the surfactants. The foam volume or maximum foam height is affected in the presence of oil.
- Out of all the tested surfactants, Makon DA 9 (non-ionic) kept a good performance for all cases.
- AOS (anionic) showed good results for 100% water case, but its performance dropped in the presence of higher oil fractions. AOS foam is relatively rigid and stable to break and may need defoamers to break.
- CTAB (cationic) showed good performance for 50% oil case. It showed better performance with cosolvent compared to without cosolvent. CTAB may cause deposition issues in surface facilities.
- Both commercial surfactants showed good results at higher concentrations (above CMC) for 50% oil case. They show lower foam stability than AOS, but this property

is useful when faster foam decay is a requirement. This means a good balance for foaming and defoaming properties required for foam lift.

- Commercial surfactant 1 shows relatively better results for all the cases than commercial surfactant 2. The difference is not very large though.
- Amphosol (Amphoteric) and Biosoft (Non-ionic) performed poorly among all. Amphosol showed slightly improved performance in liquid unloading for 25% oil case as compared to a 10% oil case.
- Biosoft failed for all the oil cases including 10% oil case. It showed a noticeable reduction in surface tension at a lower concentration, but it lacked a lot in foamability and foam stability. It can be used along with other surfactants, where it is required to introduce low surface tension with low foamability.
- Foam density increased significantly for oil cases compared to the cases with no oil. This is due to a significant reduction in foam volume for oil cases.
- Foam quality was high for 100% water cases and it decreased for higher oil cases.
- For high-temperature cases, surfactants followed similar trends to those of room temperature tests with 100% water fraction.
- For all the surfactants unloaded liquid was decreased at 50 °C as compared to room temperature.
- Makon showed good performance even for increased temperature and increased oil fraction as compared to other surfactants.

- AOS, Makon and two commercial surfactants kept up their performance at high temperatures.
- CTAB showed improvement for high temperature cases due to increased solubility, while the presence of cosolvent was not as beneficial at high temperature.
- Performance of Amphosol was improved for high temperature cases at 0% and 25%oil cases.
- CTAB showed good unloading in comparison to AOS, Makon and Commercial surfactants for 100% water case. Also, it showed the best performance with 25% oil.

5.2. Recommendations

- The future scope of this study can include conducting tests at high-pressure along with high temperature environment to better represent a well downhole. A closed loop experimental set-up can be developed for high pressure and high temperature set up. Usage of CO₂ can be experimented replacing N₂.
- The study can include variation in hydrocarbon condensates or light oils, starting from shorter chain to longer chains.
- The tests can also include varying gas flow rates to predict its effect on surfactant unloading efficiencies.

CHAPTER 5

- The deeper level analysis of foam can be conducted based on bubble size. Foam stability can be studied at bubble scale.
- Based on laboratory data, an effort can be made to develop the modeling study. This can be useful to predict the effect of surfactants in the liquid unloading, based on its concentrations, oil-water fraction.

The outcomes of this work help us better understand the performance of a given surfactant type in presence of condensate. The findings can contribute as an operational guideline for the selection of surfactants to unload gas wells with varying water cuts.

REFERENCES

REFERENCES

- [1] James F. Lea, Henry V. Nickens and Mike R. Wells, Gas Well Deliquification.
- [2] Saad Saleh and Mahmoud Al-Jamae'y, *Foam Assisted Liquid Lifting in Low Pressure Gas Wells*, SPE 37425, March 1997.
- [3] Steven Oude Heuvel and Craig Adelizzi, "www.alrdc.org," 2010. [Online]. Available:
http://www.alrdc.org/workshops/2010_2010EuropeanGasWell/Private/EH%20Foamer%20Presentation%20EuroGasWell.pdf.
- [4] Cikida Gcali , *Efficiency of Surfactant Batch Treatment in Horizontal Gas Wells (M.S. in P. E. at The University of Tulsa 2017)*.
- [5] Abdulkamil Ajani, *Experimental Study and Modeling of Effect of Surfactants on Liquid Loading in Vertical Pipes (Ph. D. at The University of Tulsa)*, 2014.
- [6] Durgesh Kawale, *Influence of Dynamic Surface Tension on Foams: Application in Gas Well Deliquification (MSc Delft University of Technology)*, 2012.
- [7] Paweena Kanokkarn, Takeo Shiina, Malee Santikunaporn and Sumaeth Chavade, "Equilibrium and dynamic surface tension in relation to diffusivity and foaming properties: Effects of surfactant type and structure," *Colloids and Surfaces A*, April 2017.
- [8] "www.kruss-scientific.com," KRÜSS GmbH, [Online]. Available:
<https://www.kruss-scientific.com/services/education-theory/glossary/surface-tension/>.
- [9] "http://www.sinterface.com," SINTERFACE Technologies. [Online].
- [10] Y. Nakama, "sciencedirect.com," in *Cosmetic Science and Technology*, 2017, pp. Section 15.2, 5.2.1.2., 9.5.5 .

REFERENCES

- [11] "www.subtech.com," [Online]. Available:
<https://www.substech.com/dokuwiki/doku.php?id=surfactants>.
- [12] J. J. Sheng, Enhanced Oil Recovery Field Case Studies, Bob J. Herd Department of Petroleum Engineering, Texas Tech University: ELSEVIER.
- [13] Maria Helena Amaral, José das Neves, Angela Z. Oliveira and M. Fernanda Bahia, "Foamability of Detergent Solutions Prepared with Different Types of Surfactants and Waters," *AOCS*, 2008.
- [14] Lok Kumar Shrestha, Durga P. Acharya, Suraj Chandra Sharma, Kenji Aramaki, Hiroshi Asaoka, Keiichi Ihara, Takeshi Tsunehiro and Hironobu Kunieda, "Aqueous foam stabilized by dispersed surfactant solid and lamellar liquid crystalline phase," *Journal of Colloid and Interface Science*, April 2006.
- [15] Magdalena Beilawska and Natalia Pawlak , "Investigation of Micellar Surfactant Systems," [Online]. Available:
http://newuc.jinr.ru/img_sections/file/Practice2012/Presentation_Europe/Sans%20method.pdf.
- [16] Achinta Bera, Keka Ojha and Ajay Mandal, "Synergistic Effect of Mixed Surfactant Systems on Foam Behavior and Surface Tension," *AOSC*, January 2013.
- [17] EHSAN MOHAJERI and GHOLAMREZA DEGHAN NOUDEH, "Effect of Temperature on the Critical Micelle Concentration and Micellization Thermodynamic of Nonionic Surfactants: Polyoxyethylene Sorbitan Fatty Acid Esters," *E-Journal of Chemistry*, April 2011.
- [18] L. Tennouga, A. Mansri, K. Medjahed, A. Chetouani and I. Warad, "The micelle formation of cationic and anionic surfactants in aqueous medium: Determination of CMC and thermodynamic parameters at different temperatures," *J. Mater. Environ. Sci.*, Sept 2015.
- [19] L.A. Noll, "The Effect of Temperature, Salinity, and Alcohol on the Critical Micelle Concentration of Surfactants," *SPE 21032*, February 1991.

REFERENCES

- [20] A. T. van Nimwegen, *The Effect of Surfactants on Gas-Liquid Pipe Flows (Ph. D. at Delft University of Technology 2015)*, 2015.
- [21] Carolina Barreto , *Effect of Foamer Delivery Location on Horizontal Wells Deliquification (M.S. in P. E. at The University of Tulsa 2016)*.
- [22] JiangYANG, "High Performance Foams for Unloading Gas Wells". TX/USA Patent Pub.No.:US2008/0217009A1, 11 September 2008.
- [23] Chegenizadeh Negin, Saeedi Ali and Quan Xie, "Most common surfactants employed in chemical enhanced oil recovery," *KeAi Advanced Research Science*, November 2016.
- [24] Durgeh Kawale, A.T. van Nimwegen, L.M. Portela, M.A. van Dijk and R.A.W.M. Henke, The relation between the dynamic surface tension and the foaming behaviour in a sparger setup (Delft University of Technology and Shell Projects), May 2015.
- [25] Amita Kosambi, Hamidreza Karami and Sepideh Raza, "Experimental Characterization of Surfactant Application in Gas Wells and in Presence of Water and Condensates," in *AIChE*, 2019 (not yet published).
- [26] Shuoshi Wang, Changlong Chen, Na Yuan, Yixin Ma, Onyekachi I. Ogbonnaya, Benjamin Shiau and Jeffrey H. Harwell, "Design of extended surfactant-only EOR formulations for an ultrahigh salinity oil field by using hydrophilic lipophilic deviation (HLD) approach: From laboratory screening to simulation," *FUEL*, 2019.

APPENDIX

DST plots for various surfactants

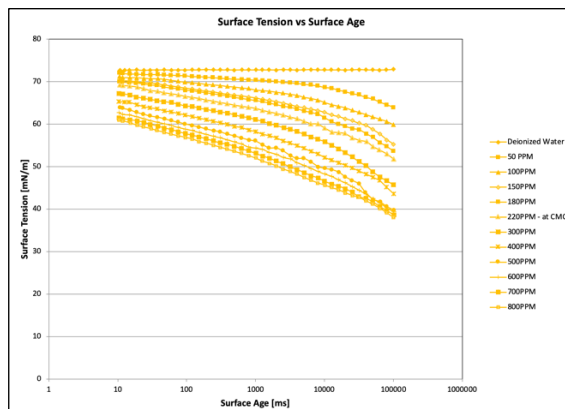
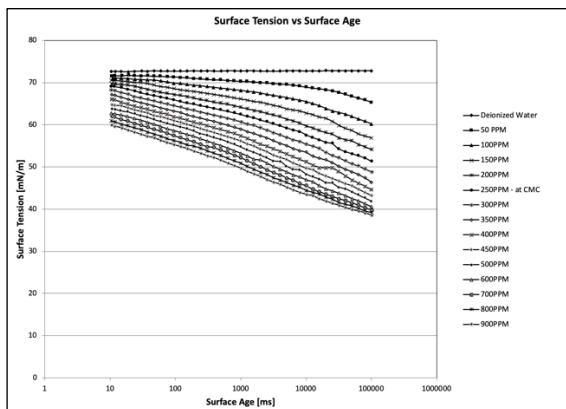

DST plots for Commercial Surfactant 1 and 2

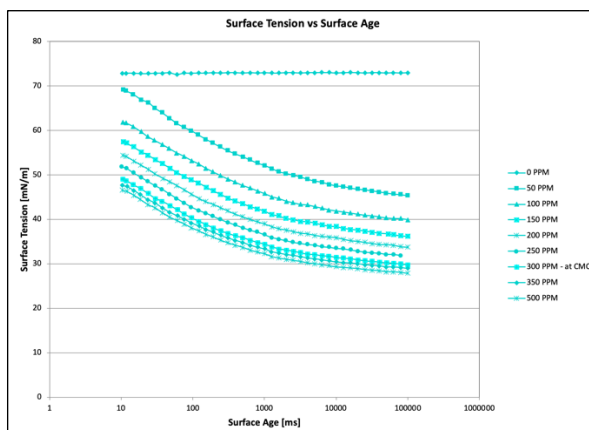

DST Tests for Makon DA 9

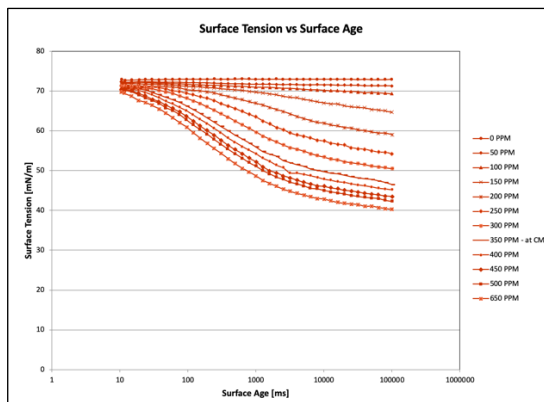
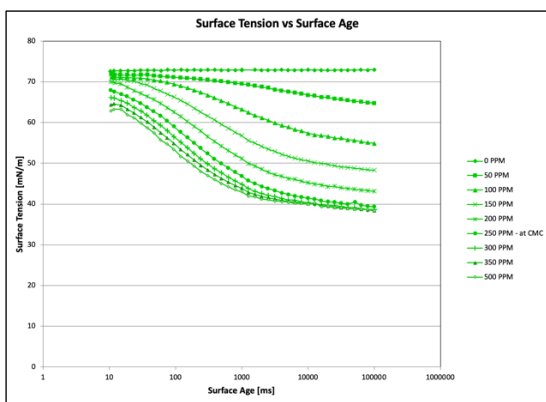

DST Tests for CTAB (C) and CTAB (NC)

APPENDIX

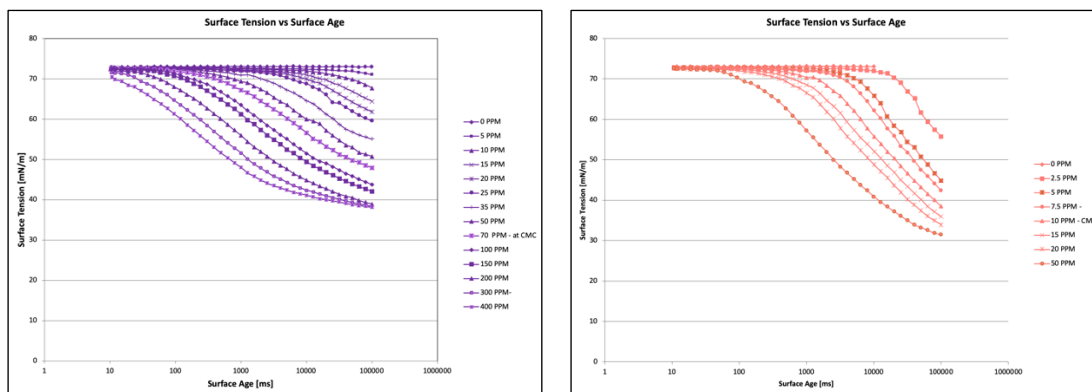

DST plots for Amphosol and Biosoft at different concentrations

Figure A.1. Dynamic Surface Tension Plots for various Surfactants

Changes in Foam Height and drained Liquid Height, for No Oil case

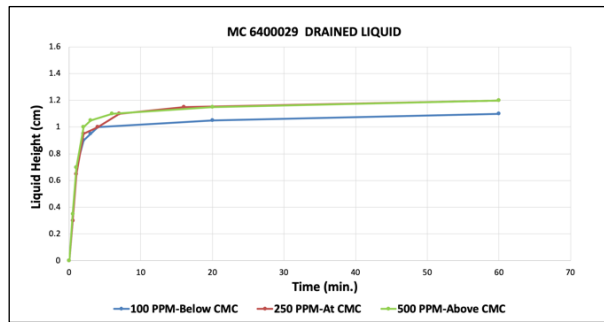
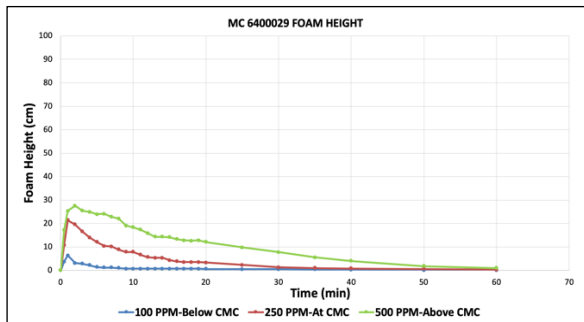

Changes in Liquid Height with Time with for Commercial Surfactant 1

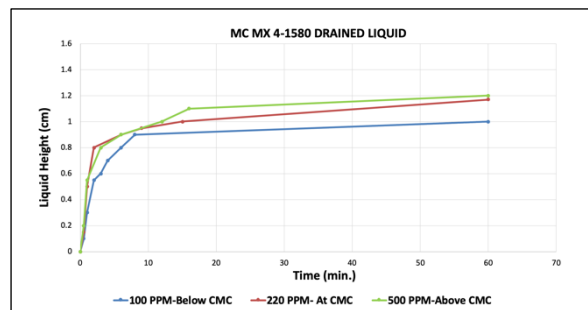
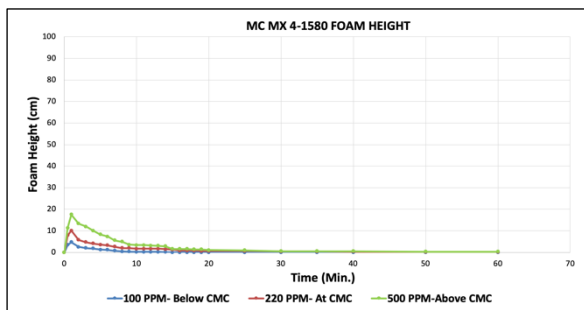

Changes in Liquid Height with Time with for Commercial Surfactant 2

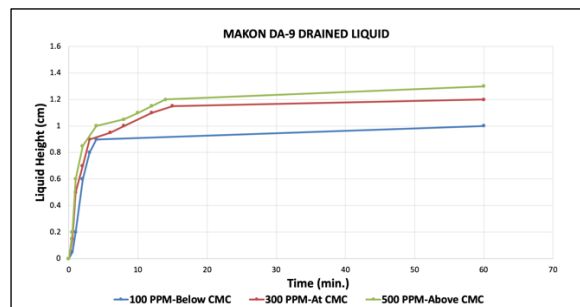
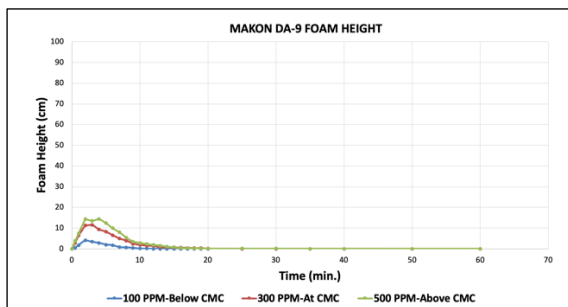

Changes in Liquid Height with Time with for Makon DA 9

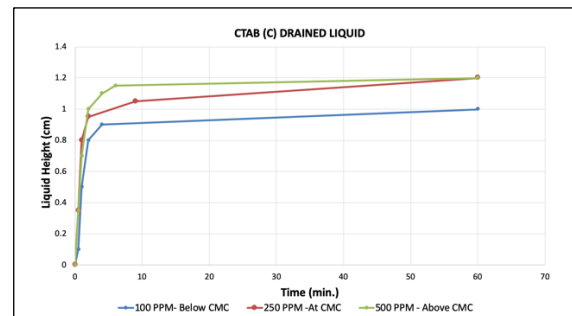
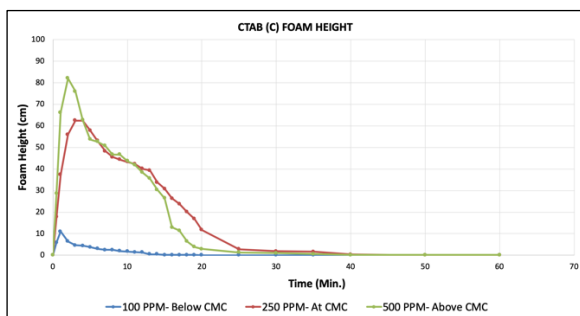

Changes in Liquid Height with Time with for CTAB (C)

APPENDIX

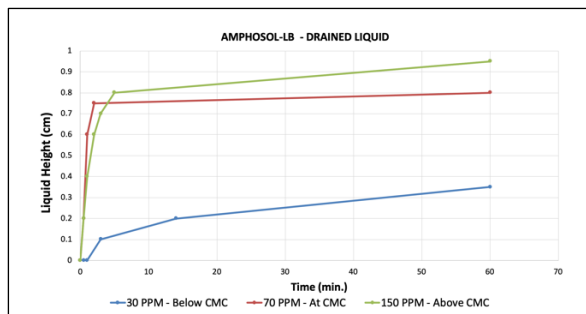
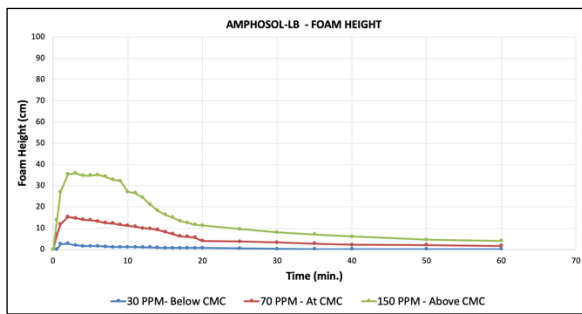

Changes in Liquid Height with Time with for Amphosol LB

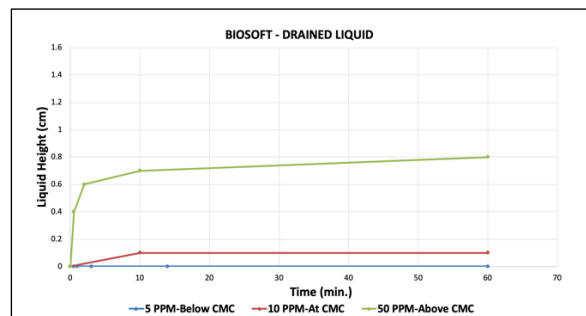
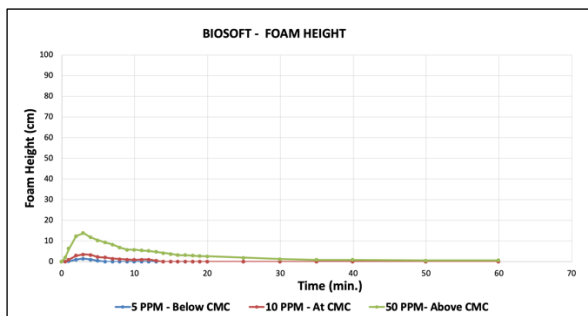

Changes in Liquid Height with Time with for Biosoft

Figure A.2. Changes in Foam and Liquid Height for Surfactant, No Oil case

APPENDIX

Changes in Foam Height and drained Liquid Height for 10% Oil

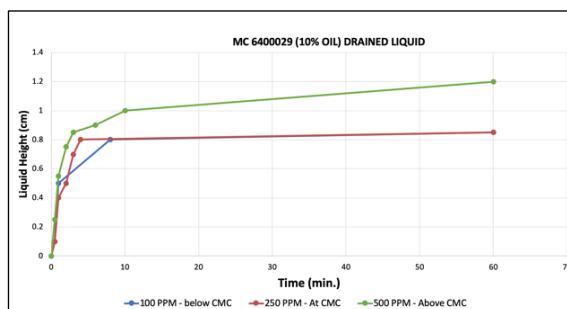
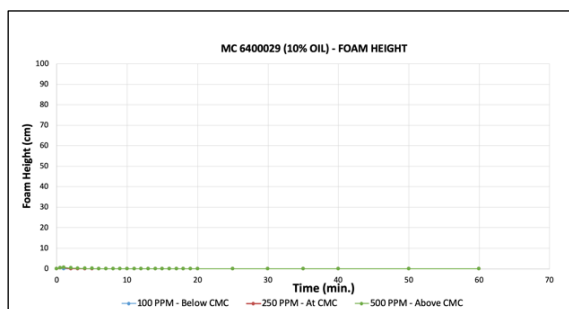

Changes in Liquid Height with Time with Commercial surfactant 1 for 10% Oil

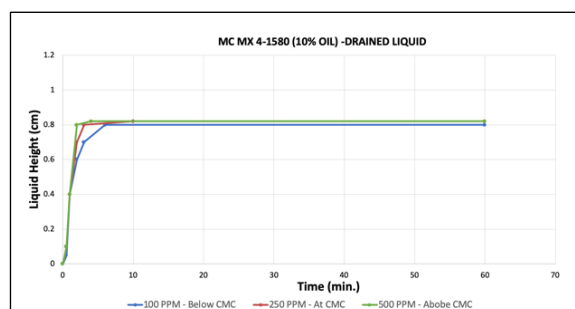
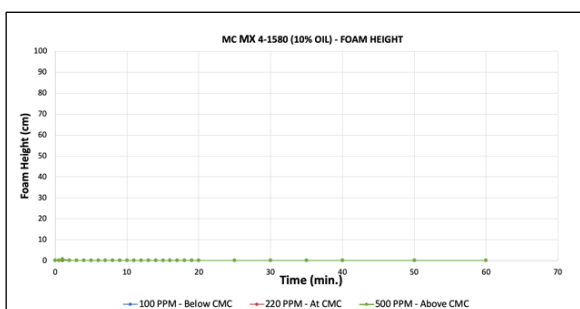

Changes in Liquid Height with Time with Commercial surfactant 2 for 10% Oil

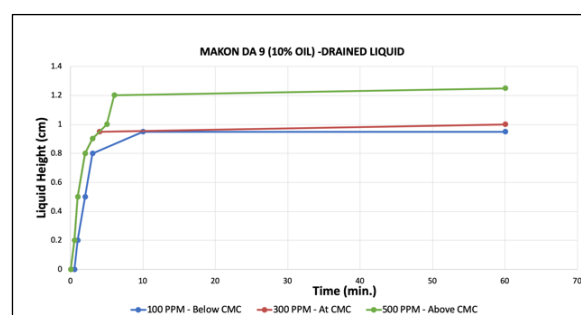
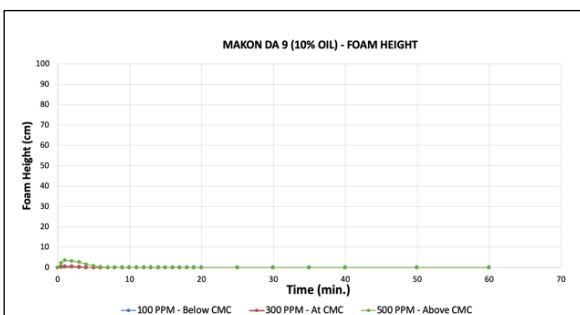

Changes in Liquid Height with Time for Makon, for 10% Oil

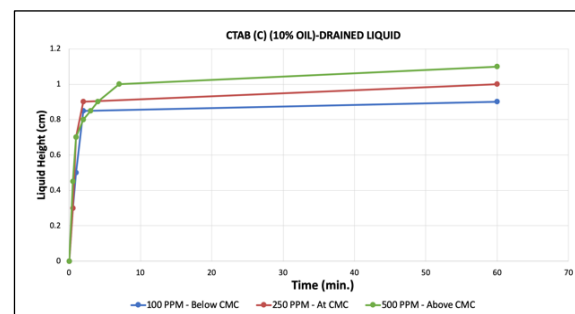
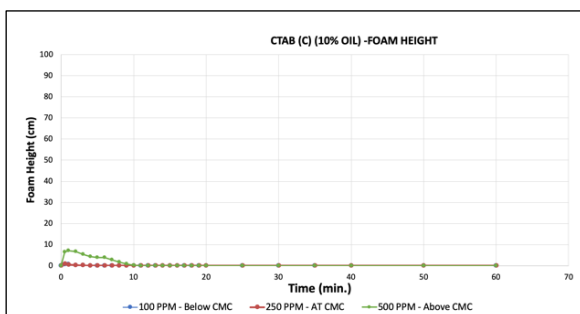

Changes in Liquid Height with Time for CTAB (C), for 10% Oil

APPENDIX

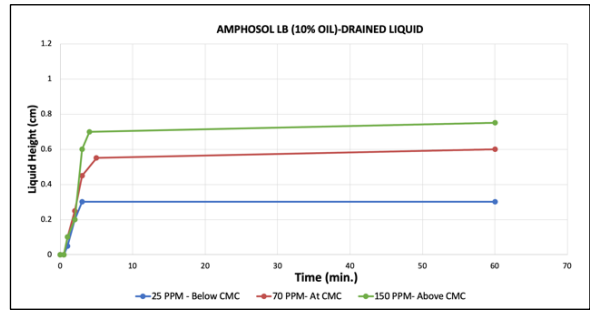
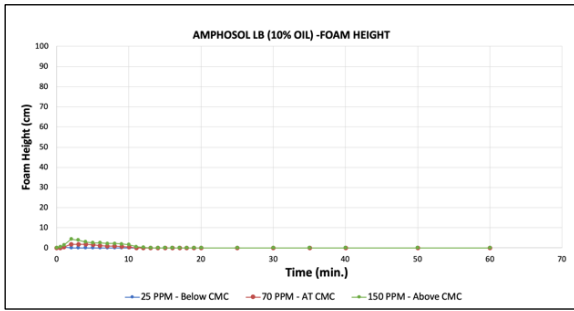

Changes in Liquid Height with Time for Amphosol LB, for 10% Oil

Figure A.3. Changes in Liquid Height with Time for Surfactants, for 10% Oil case

Changes in Foam Height and drained Liquid Height, for 25% Oil case

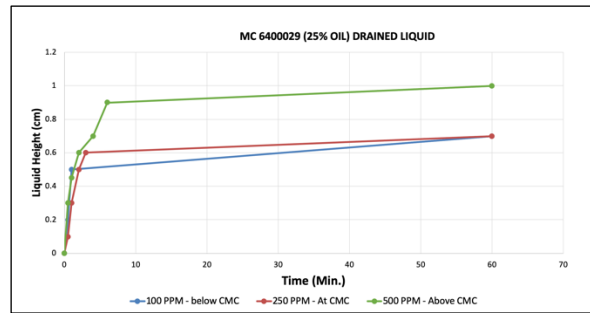
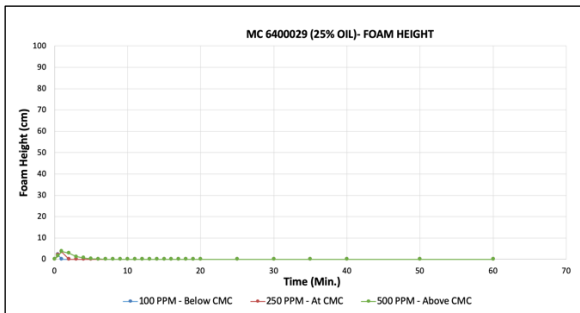

Changes in Liquid Height with Time with Commercial surfactant 1 for 25% Oil

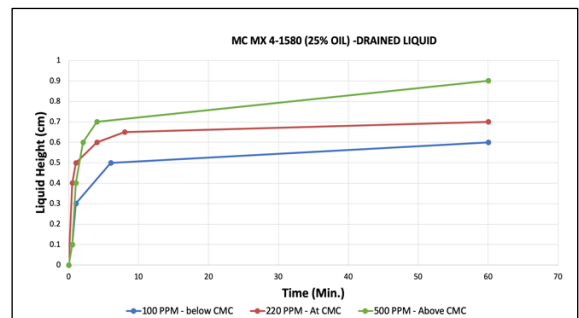
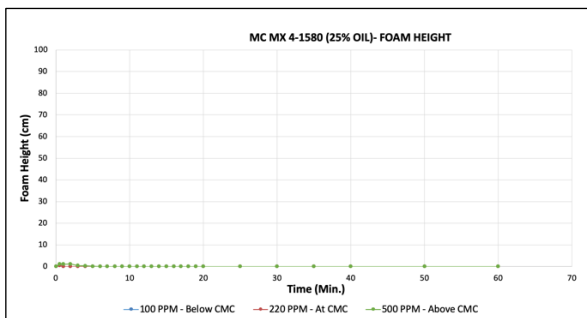

Changes in Liquid Height with Time with Commercial surfactant 2 for 25% Oil

APPENDIX

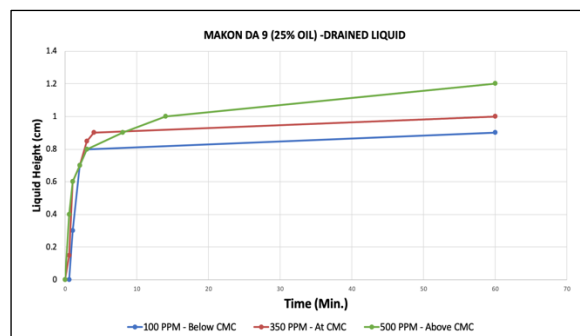
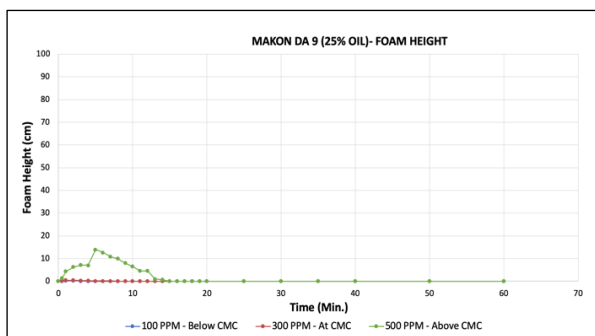

Changes in Liquid Height with Time with Makon for 25% Oil

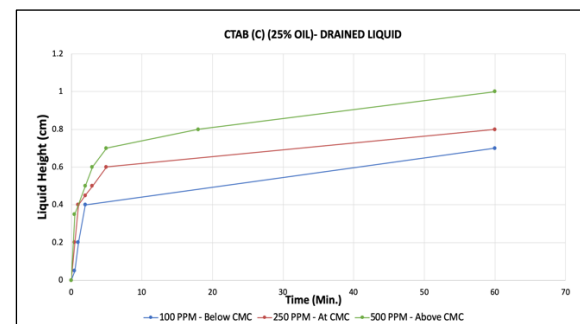
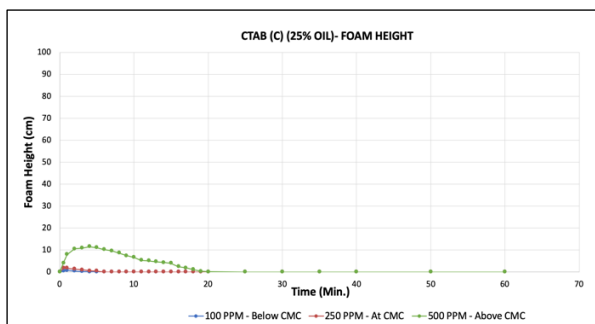

Changes in Liquid Height with Time with CTAB (C) for 25% Oil

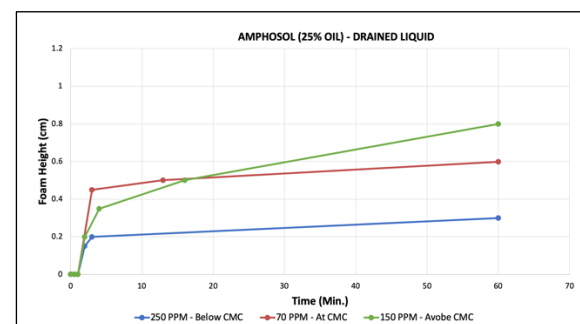
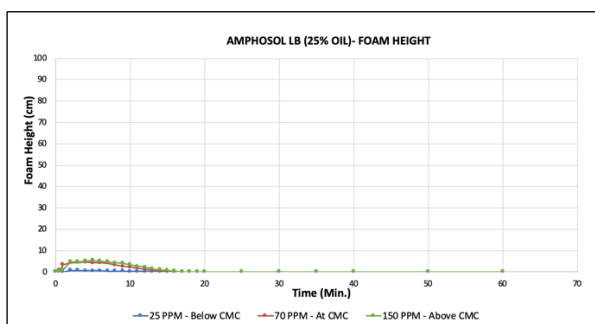

Changes in Liquid Height with Time with Amphosol for 25% Oil

Figure A.4. Changes in Liquid Height with Time for Surfactants, for 25% Oil

APPENDIX

Changes in Foam Height and drained Liquid Height, for 50% Oil case

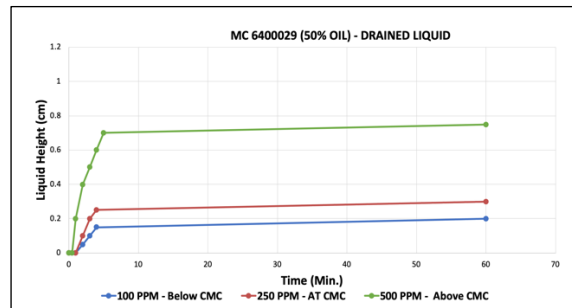
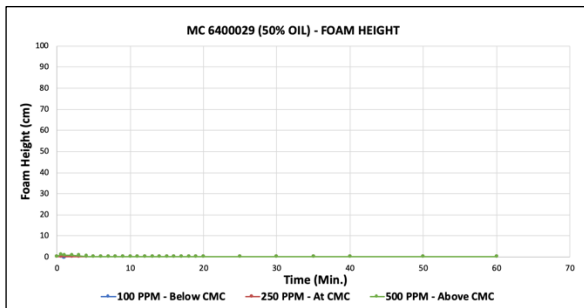

Changes in Foam height and Drained Liquid Height - Commercial Surfactant 1 for 50% Oil

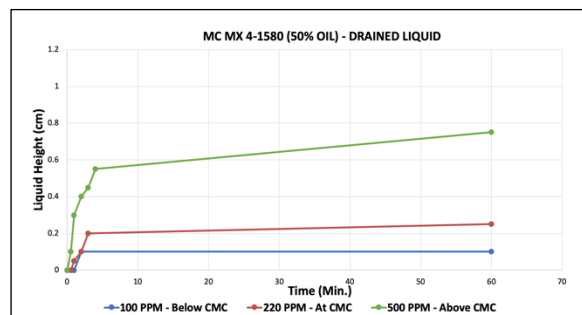
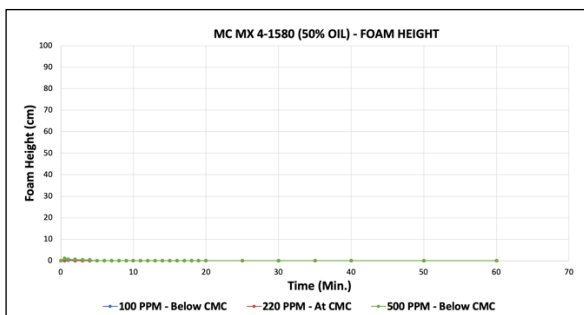

Changes in Foam height and Drained Liquid Height - Commercial Surfactant 2 for 50% Oil

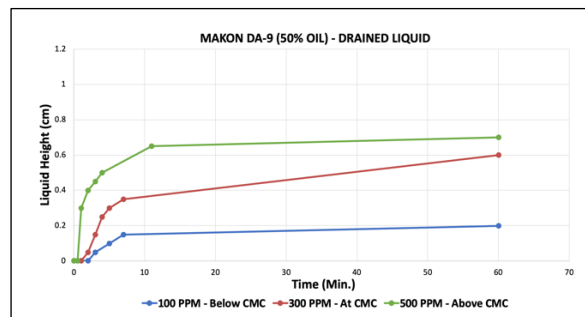
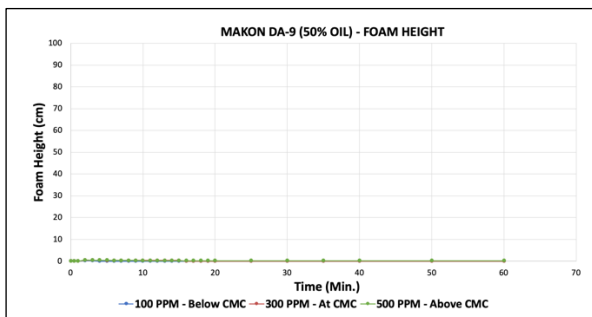

Changes in Foam height and Drained Liquid Height for Makon for 50% Oil

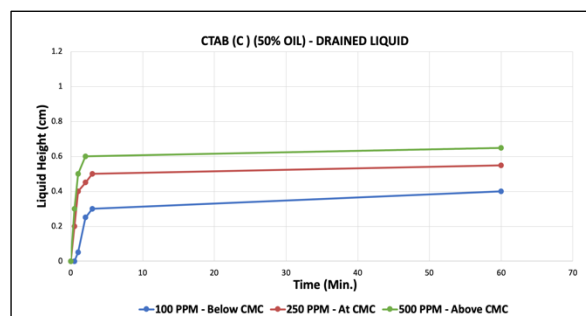
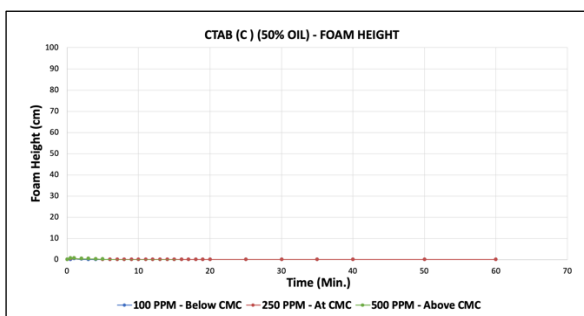

Changes in Foam height and Drained Liquid Height for CTAB(C) for 50% Oil

APPENDIX

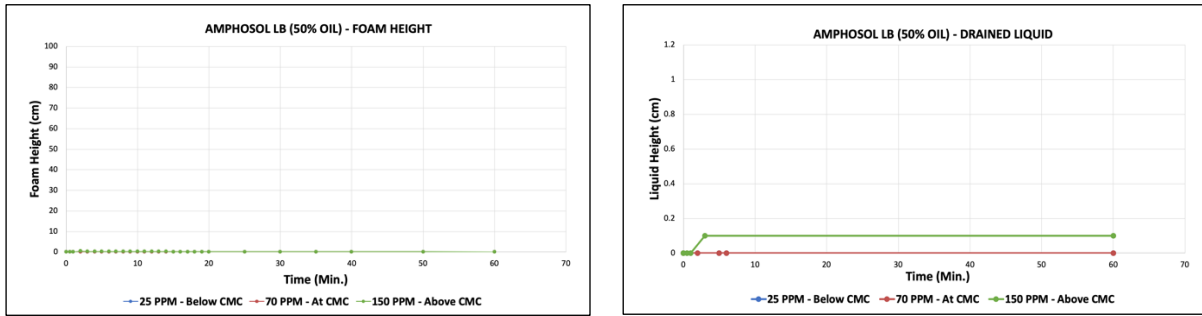

Changes in Foam height and Drained Liquid Height for Amphosol LB for 50% Oil

Figure A.5. Changes in Foam Height for Surfactants for 50% Oil

Liquid Unloaded and Remaining for Surfactants, all water-oil fractions

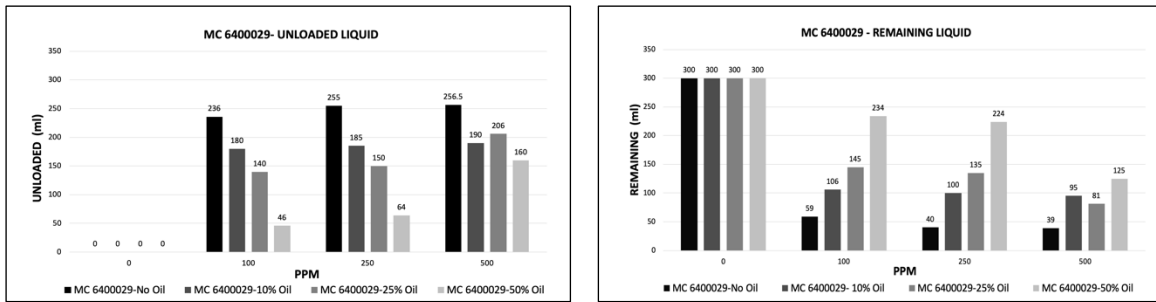

Commercial surfactant 1 - Liquid Unloaded and Remaining

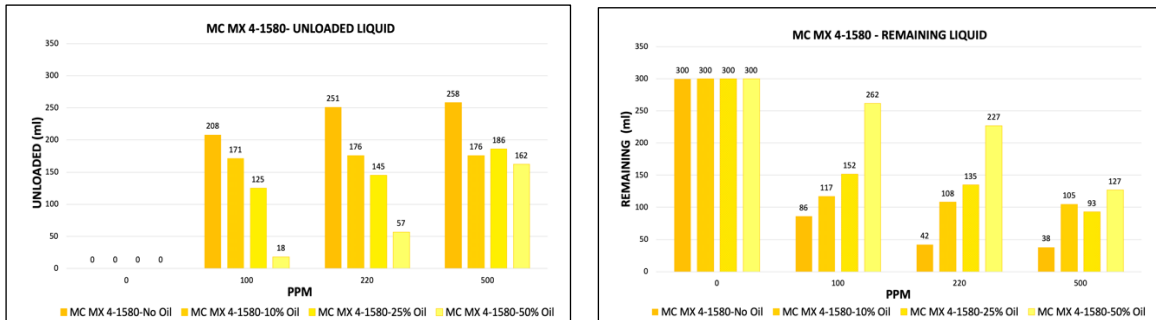

Commercial surfactant 2 - Liquid Unloaded and Remaining

APPENDIX

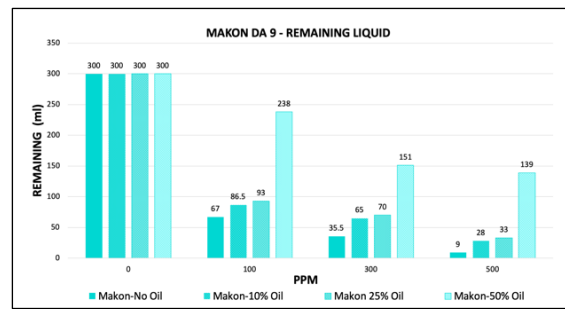
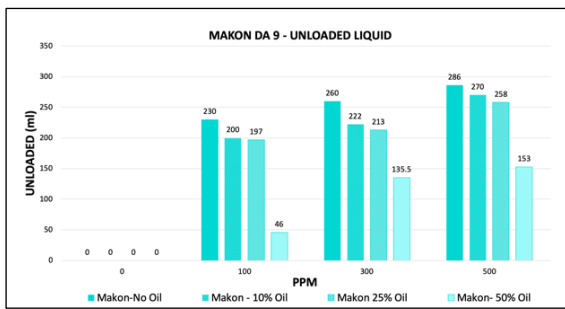

MAKON DA-9 - Liquid Unloaded and Remaining

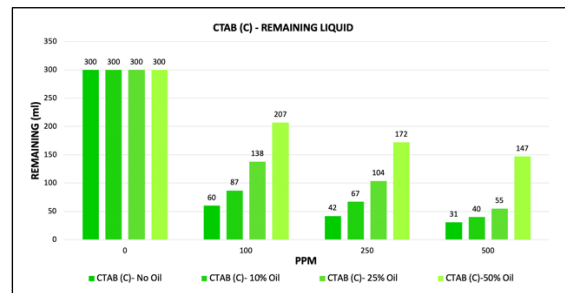
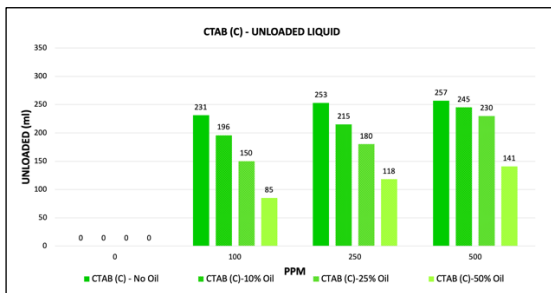

CTAB - Liquid Unloaded and Remaining

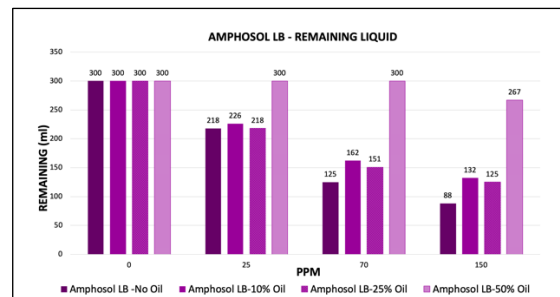
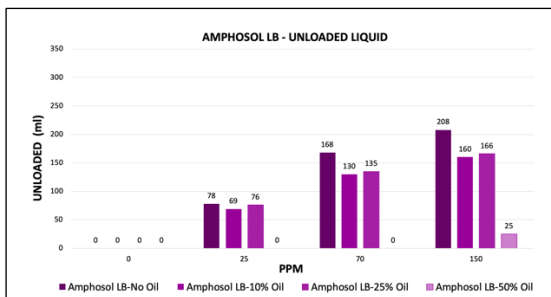

AMPHOSOL LB - Liquid Unloaded and Remaining

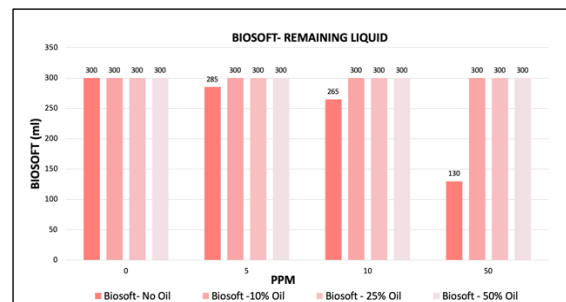
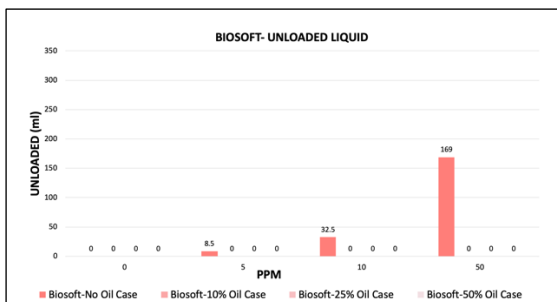

BIOSOFT - Liquid Unloaded and Remaining

Figure A.6. Liquid Unloaded and Remaining for various Surfactants, all water-oil fractions

Percentage Reduction for all the surfactants

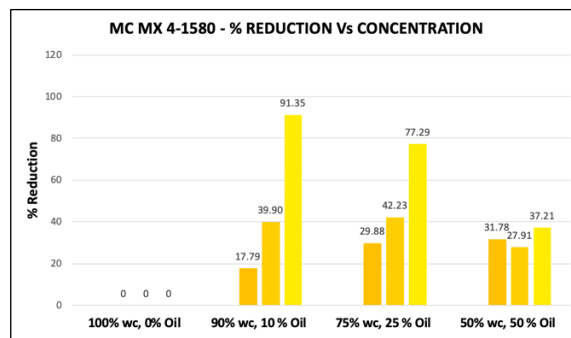
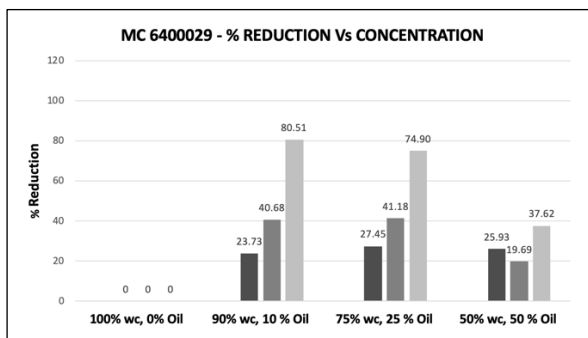

Percentage Reduction for Commercial Surfactant 1 and 2

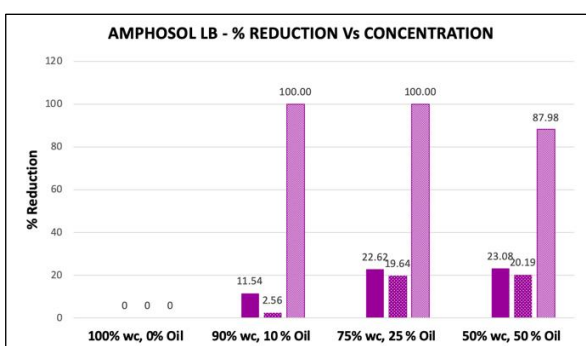
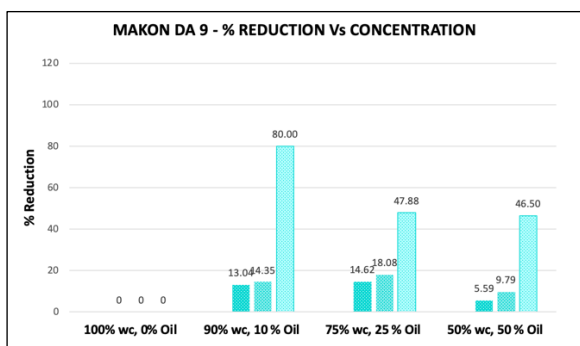

Percentage Reduction for MAKON DA 9 and AMPHOSOL LB

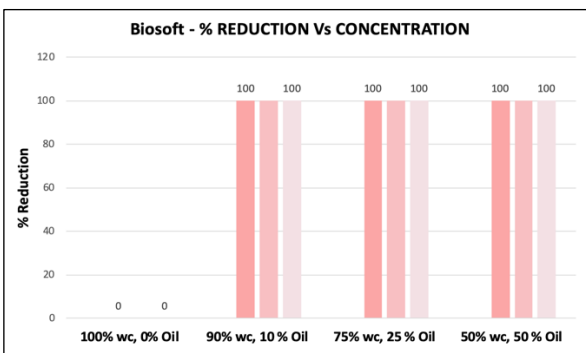
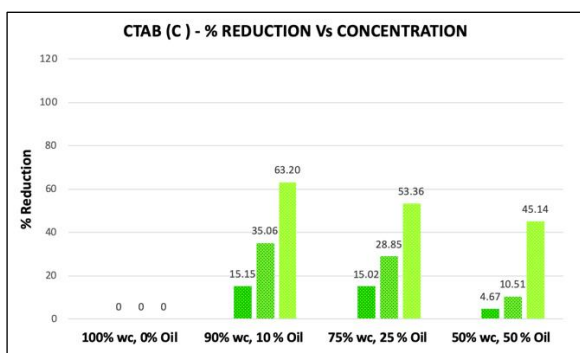

Percentage Reduction for CTAB and BIOSOFT

Figure A.7. Percentage Reduction for all surfactants

APPENDIX

Changes in Foam Height and drained Liquid Height, for 100% water case, at 50 °C

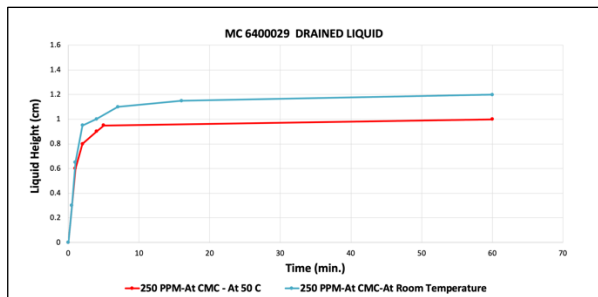
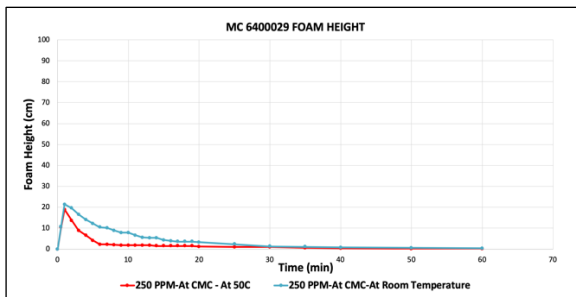

Foam and Liquid Height – Commercial Surfactant 1, 100% water, at two temperatures

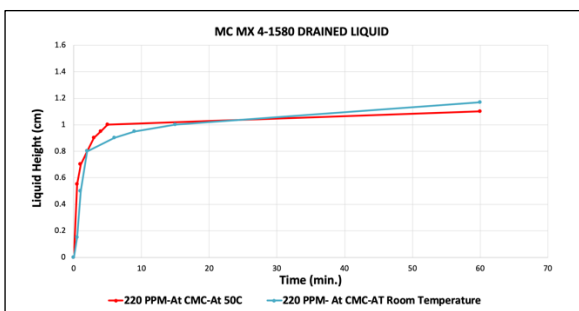
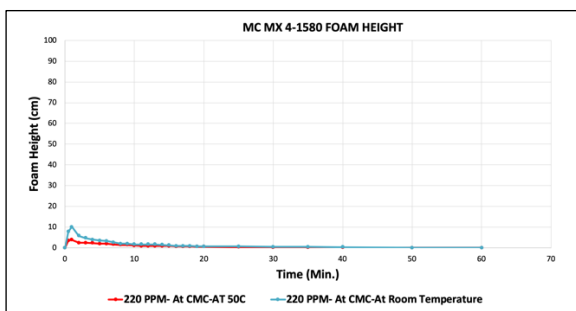

Comparison at 50 °C, for Foam and Liquid Height – Commercial Surfactant 2, 100% water

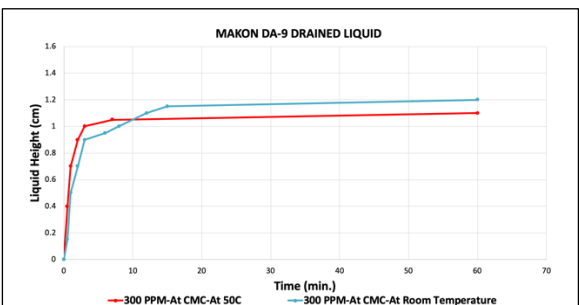
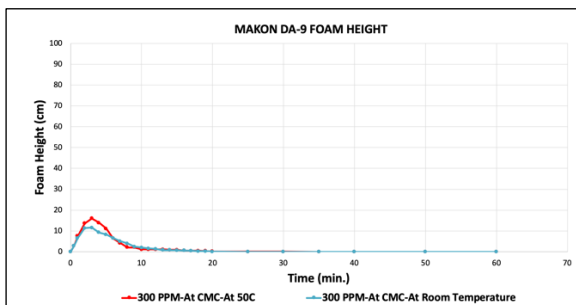

Comparison at 50 °C, for Foam and Liquid Height – Makon, 100% water

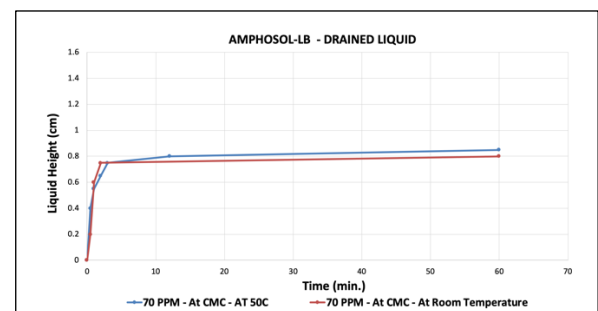
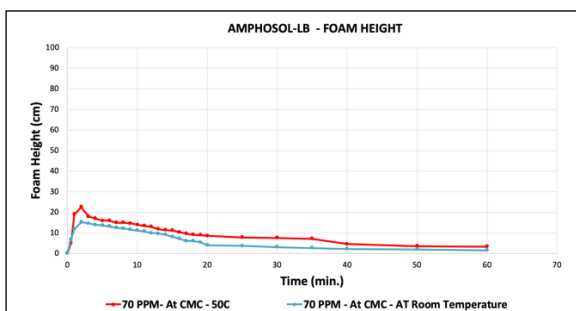

Comparison 50 °C, for Foam and Liquid Height – Amphosol, 100% water

APPENDIX

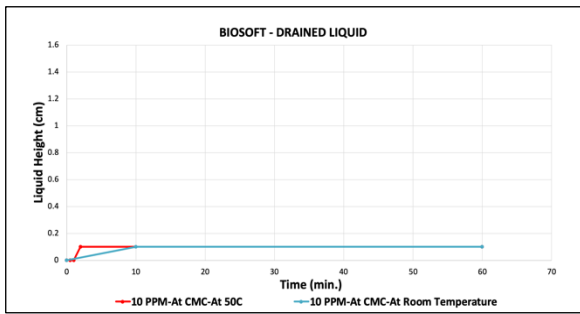
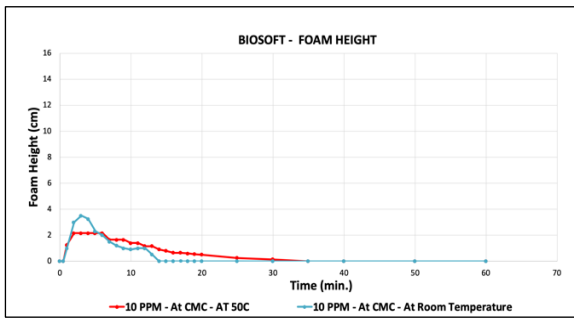

Comparison 50 °C, for Foam and Liquid Height – Biosoft, 100% water

Figure A.8. Comparison at 50 °C, Foam and Liquid Height, 100% water case

Changes in Foam Height and drained Liquid Height, for 25% water case, at 50 °C

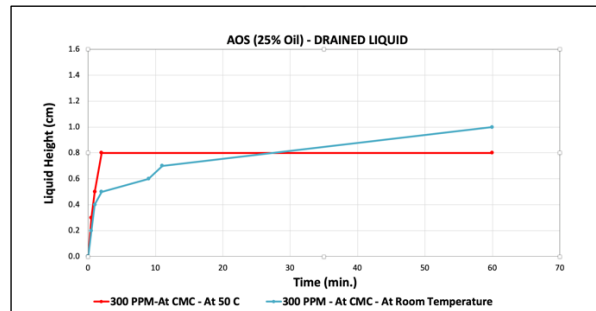
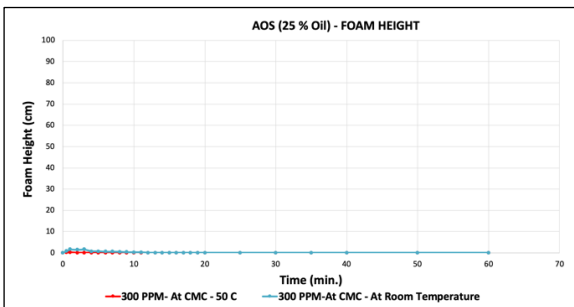

Comparison for Foam and Liquid Height for AOS for 25% water case, at two temperatures

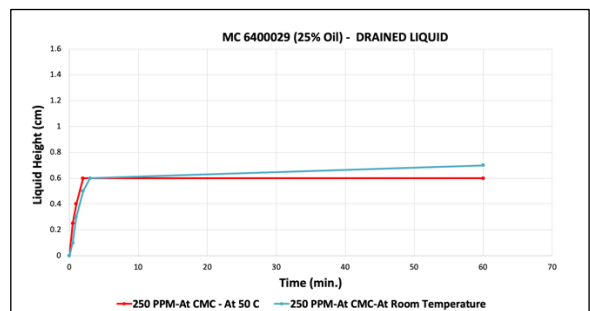
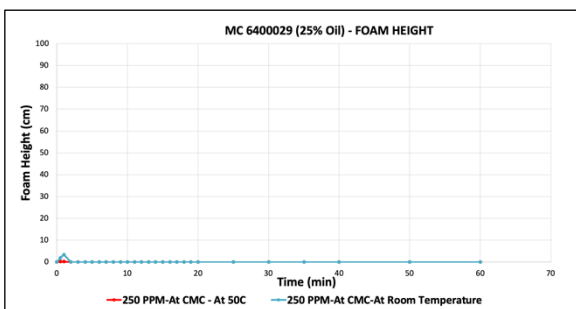

Comparison for Foam and Liquid Height for Commercial Surfactant 1 for 25% oil

APPENDIX

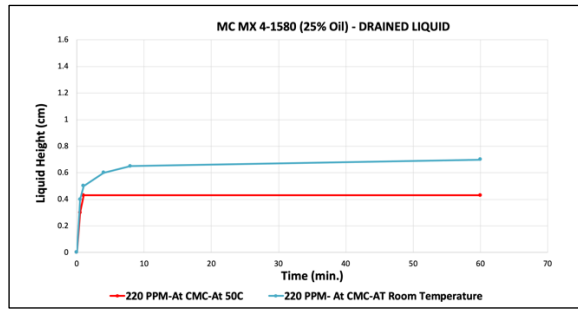
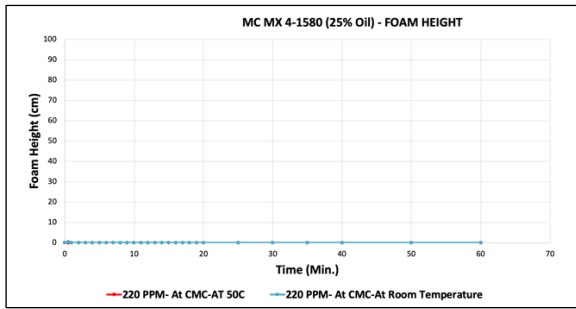

Comparison for Foam and Liquid Height for Commercial Surfactant 2 for 25% oil

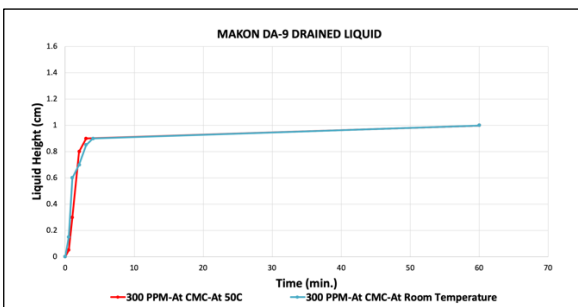
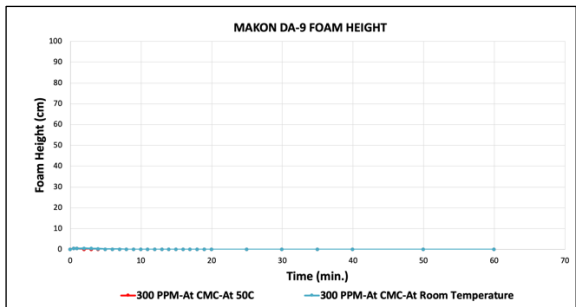

Comparison for changes in Foam and Liquid Height for Makon for 25% oil

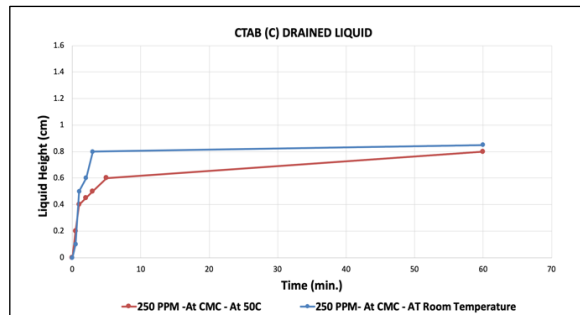
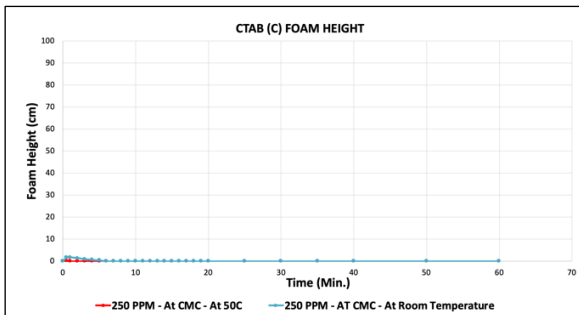

Comparison for changes in Foam and Liquid Height for CTAB(C) for 25% oil

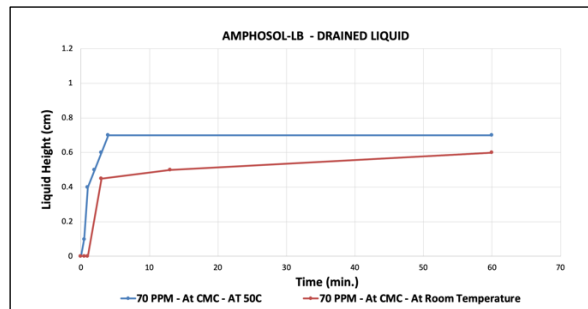
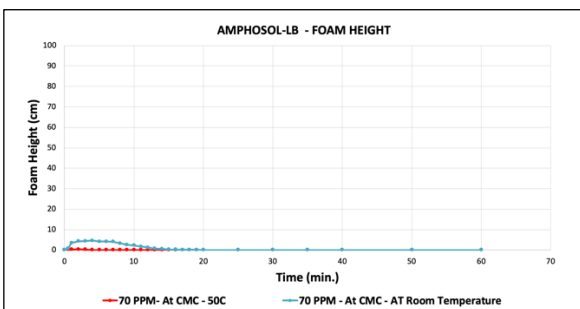

Comparison for changes in Foam and Liquid Height for Amphosol LB for 25% oil

Figure A.9. Comparison at 50 °C, Foam and Liquid Height, 25% oil case

APPENDIX

Liquid Unloaded and Remaining for 50 °C, for 100% water and 75% water cuts

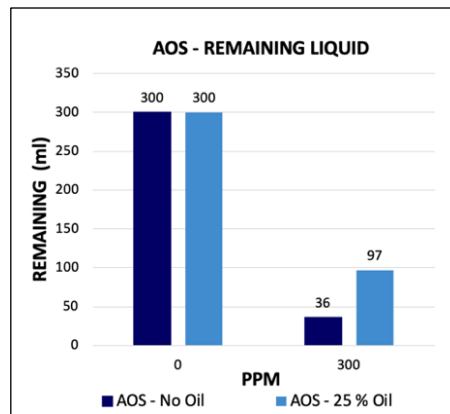
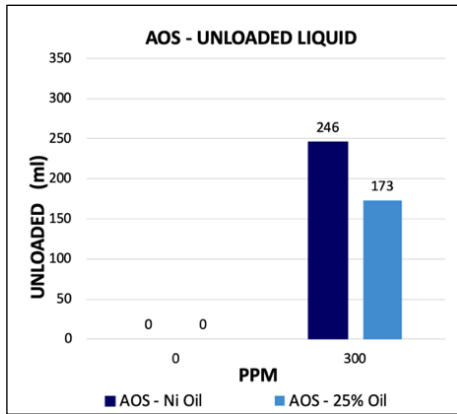

AOS, Unloaded and Remaining Liquid

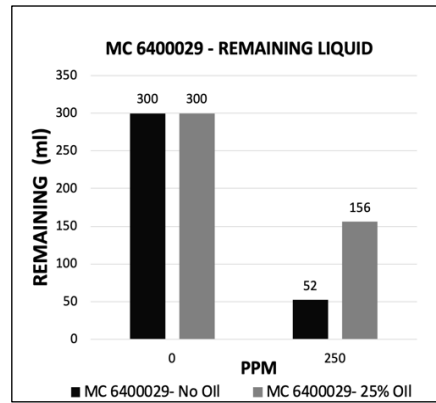
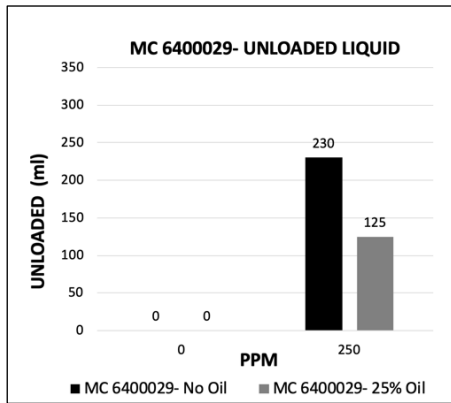

Commercial Surfactant 1 Unloaded and Remaining Liquid

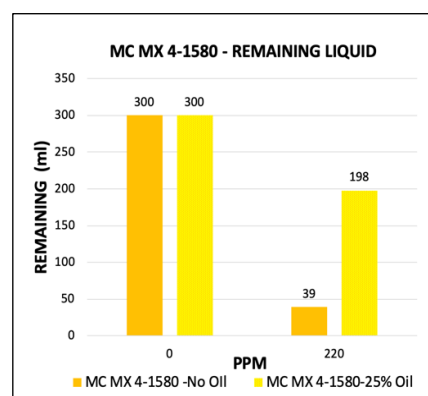
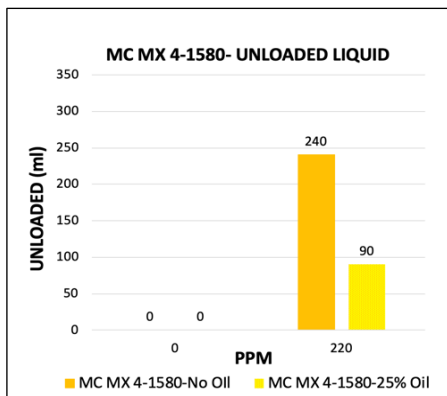

Commercial Surfactant 2 Unloaded and Remaining Liquid

APPENDIX

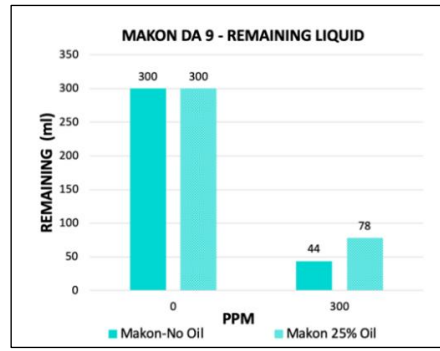
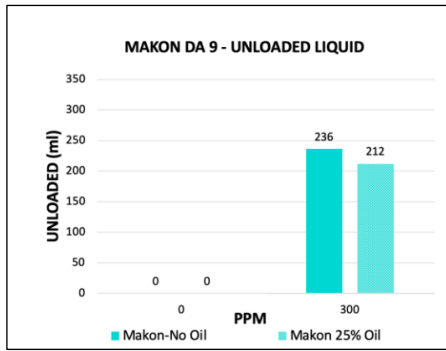

Makon, Unloaded and Remaining Liquid

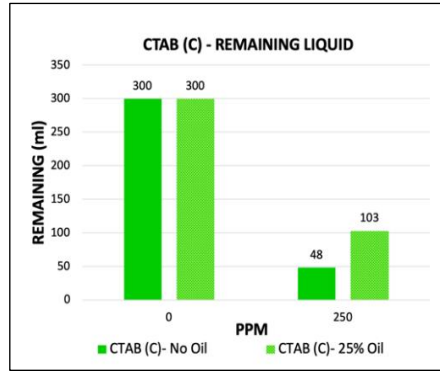
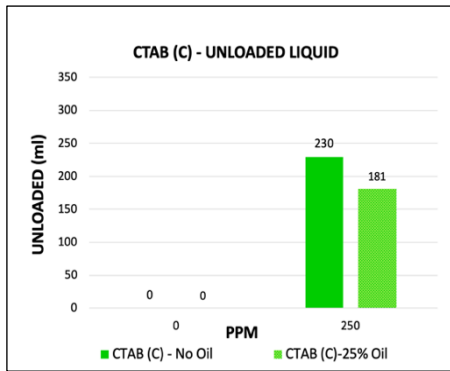

CTAB (C), Unloaded and Remaining Liquid

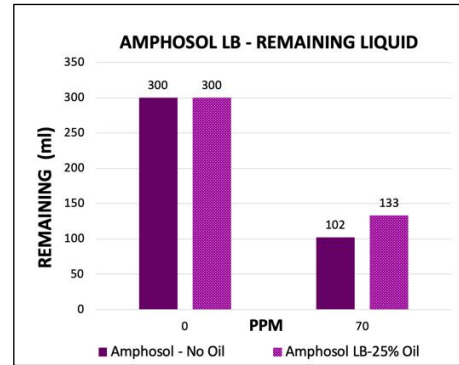
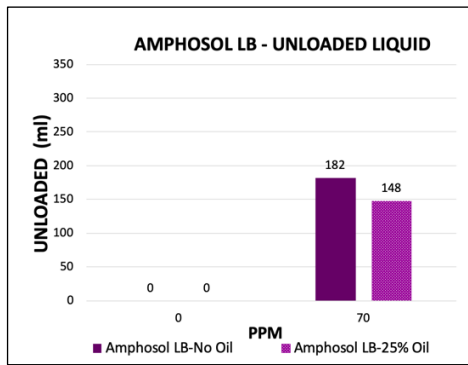

Amphosol LB, Unloaded and Remaining Liquid

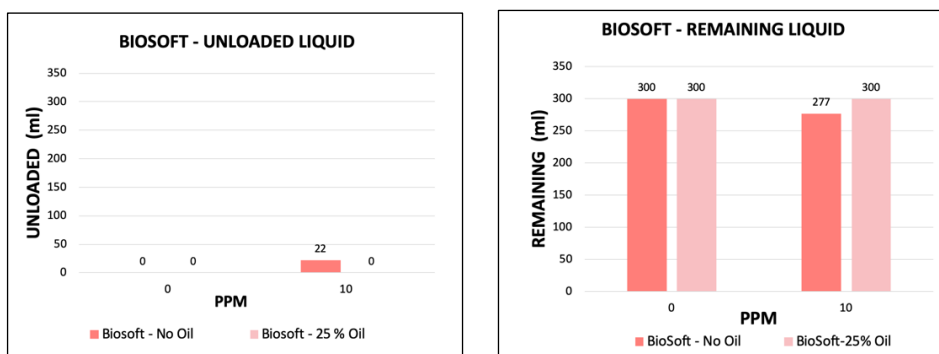

Biosoft, Unloaded and Remaining Liquid

Figure A.10. Unloaded and Remaining Liquid volume for Surfactant at 50 °C

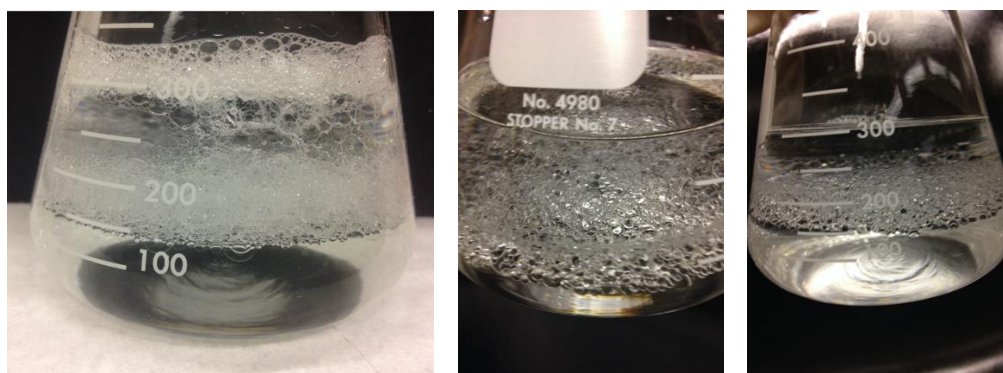

Figure A.11 Solutions prepared for AOS, Commercial Surfactant 1 and 2 above CMC

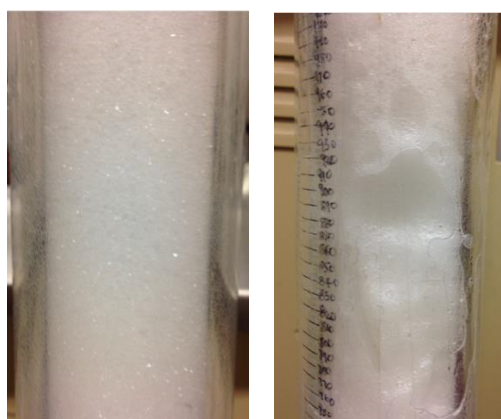

Figure A.12 AOS foam for 100% water case and 10% oil case

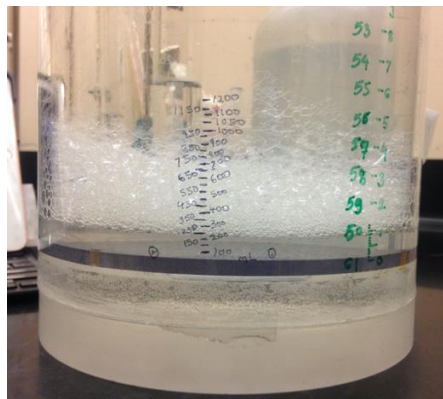
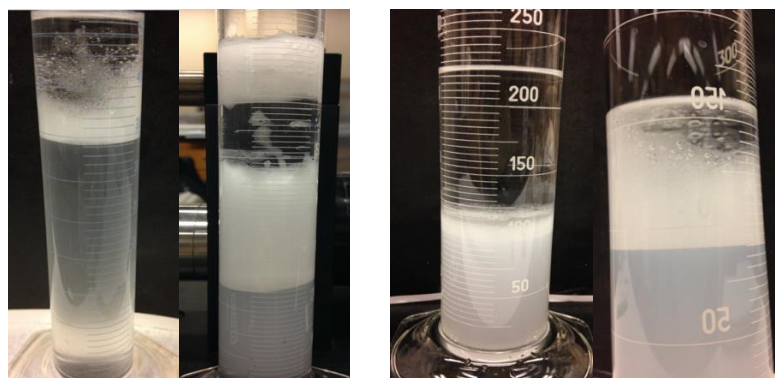

Figure A.13 AOS foam for 100% water case, at the end of 60 min of unloading test



Figure A.14 Unloaded, remaining liquid, AOS below CMC, Makon above CMC, 25% oil



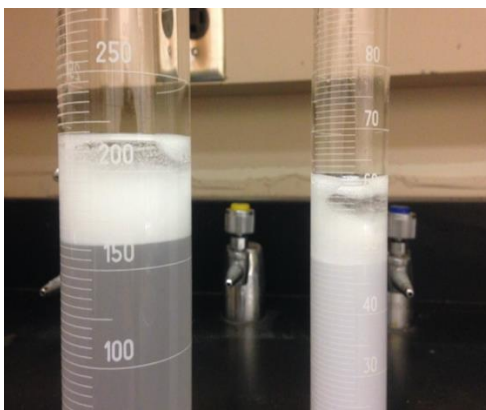

Figure A.15 Commercial surfactant 1, 2 and Makon, Unloaded and Remaining Liquid above CMC, 50% oil case

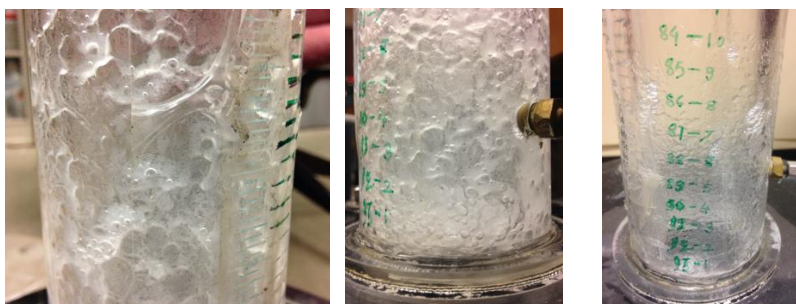

Figure A.16 Emulsion and gel deposition in production column, Amphosol, Commercial Surfactant- above CMC, 50% oil



Figure A.17 Limited solubility of CTAB in water and precipitation

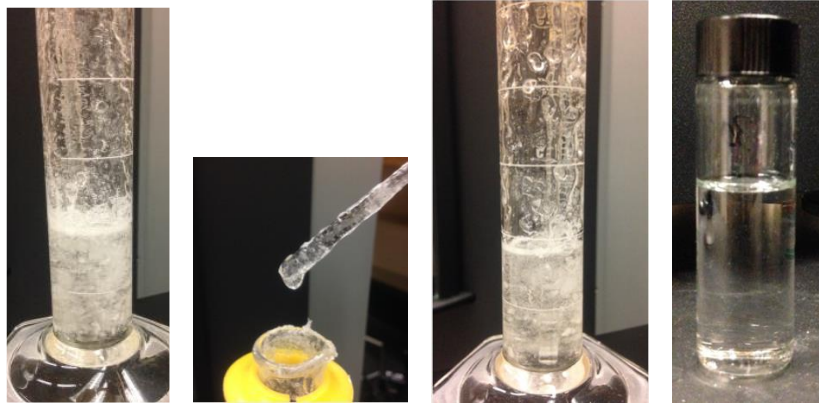

Figure A.18 CTAB mixture with isopropanol and water

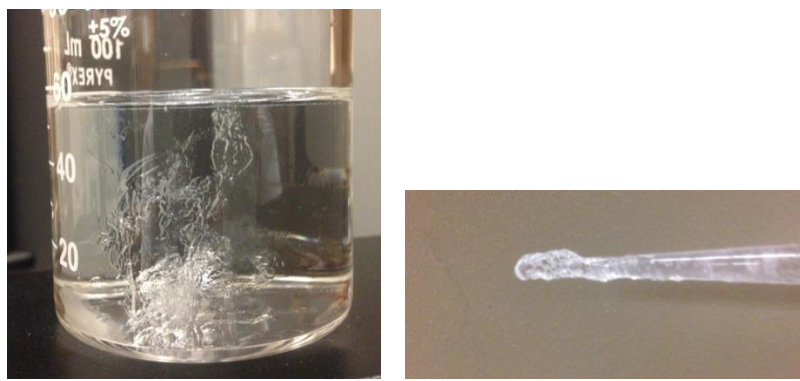

Figure A.19 Gel formation and solubility issues of Biosoft in water



Figure A.20 Oil and water deposition on inner surfaces, counted in losses

APPENDIX

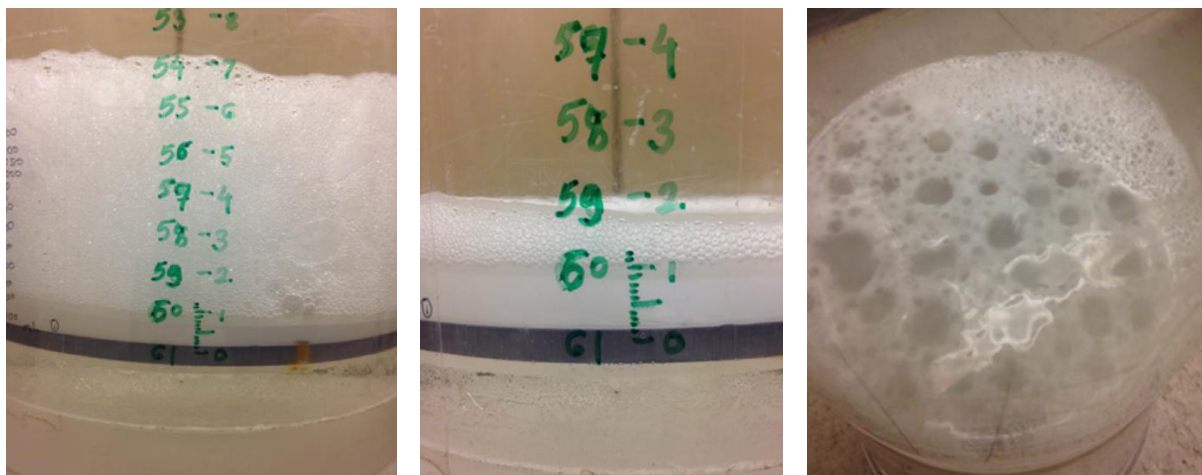

Figure A.21 Foam decay for 50% oil case, Oil-water interface and embedded foam in the oil

APPENDIX

Physical and Chemical Properties of selected Surfactants and Isopar L

AOS

Chemical Groups: Alpha Olefin Sulfonates

Product identifier: POLYSTEP A-18, Sodium (C14-16) olefin sulfonate

Synonyms: Sulfonic acids, sodium salts, AOS

Molecular Formula: $C_nH_{2n-1}SO_3Na$ (n= 14 - 16)

General Structure: $R-CH=CH-(CH_2)_n-S(=O)_2O^-Na^+$

Molecular Structure [9]:

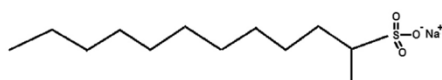

Molecular Weight: 298.42 - 344.49 (avg 326 g/gmol)

Active: 39 %

Composition:

Chemical name of substance	CAS number	%
Sodium (C14-16) olefin sulfonate	68439-57-6	30 - < 40
Alkenes, C>10. alpha. -	64743-02-8	1 - < 3
Sodium Sulfate	7757-82-6	< 2
Other components below reportable levels		< 1
Water	7732-18-5	50 - < 60

Commercial Surfactant 1

Product Trade Name: MC 6400029 (Witcolate 1276)

Manufacturer/ Supplier Company: Multi-Chem Group LLC (Halliburton Energy Services Inc)

APPENDIX

Composition:

Chemical name of substance	CAS number	%
Poly (oxy-1,2-ethanediyl), alpha-sulfo-omega-(dodecyloxy)- ammonium salt	32612-48-9	30-60
Isopropanol	67-63-0	10-30
Ethoxylated Lauryl Alcohol (23 EO)	Proprietary	5-10
Ethoxylated Decyl Alcohol	Proprietary	5-10

Commercial Surfactant 2

Product Trade Name: MC MX 4-1580

Manufacturer/ Supplier Company: Multi-Chem Group LLC (Halliburton Energy Services Inc)

Composition:

Chemical name of substance	CAS number	%
Ammonium Salt of Ethoxylated Alcohol Sulfate	Proprietary	60-100
Isopropanol	67-63-0	10-30
Alcohol, (C6-10) Ethoxylated	70879-83-3	1-5

CTAB:

Product identifiers: Cetyl Trimethyl Ammonium Bromide

Synonym: CTAB, Hexadecyltrimethylammonium bromide,
Palmityltrimethylammonium bromide

Linear Formula: $\text{CH}_3(\text{CH}_2)_{15}\text{N}(\text{Br})(\text{CH}_3)_3$

APPENDIX

C₁₉H₄₂NBr

Molecular structure of CTAB [1]:

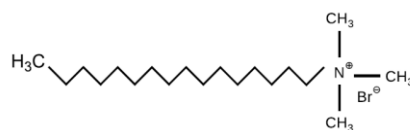

Active: 90 - 100 %

Molecular weight: 364.45 g/mol

Composition:

Chemical name of substance	CAS number	%
Hexadecyltrimethylammonium bromide OR Cetyl Trimethyl Ammonium Bromide	57-09-0	95-100

Amphosol LB:

Product Name: AMPHOSOL LB

Manufacturer/ Supplier Company: Stepan Company

Active: 30 %

Composition:

Chemical name of substance	CAS number	%
Lauramidopropyl Betaine	4292-10-8	20-30
Myristamidopropyl Betaine	59272-84-3	5-10
Sodium Chloride	7647-14-5	1-3
Water	7732-18-5	60-70

MAKON DA-9:

Product Name: MAKON DA-9

Chemical description: DECYL ALCOHOL ETHOXYLATE, POE-9

Moles of PEO: 9

APPENDIX

Chemical group: Alkoxylates, Alcohol Ethoxylates, Decyl Alcohol Ethoxylates

Manufacturer/ Supplier Company: Stepan Company

Active: 100%

Composition:

Chemical name of substance	CAS number	%
Isodecyl Alcohol Ethoxylate	78330-20-8	90-100
Other component below reportable levels		<0.1

BIOSOsFT EC-690:

Product Name: BIO-SOFT EC-690

Chemical description: ETHOXYLATED ALCOHOL (C10-C16)

Composition:

Chemical name of substance	CAS number	%
Ethoxylated Alcohol (C10-16)	68002-97-1	89-91
Water	7732-18-5	5 -<10

Oil:

Product Name: ISOPARTM L Fluid

Product Description: Isoparaffinic Hydrocarbon, C11-13 Isoparaffin

Manufacturer/ Supplier Company: ExxonMobil Chemical Company

Molecular weight: 162 g/gmol

APPENDIX

Composition:

Chemical name	CAS number	%
Naphtha (Petroleum), Hydrotreated Heavy	64742	100

Pour Point: -69°C

Flash point: 62°C

Boiling Point: 190°C

APPENDIX

Abbreviations

ST	Surface Tension
DST	Dynamic Surface Tension
CMC	Critical Micelle Concentration
IFT	Interfacial Tension
CTAB	Cetyltrimethylammonium Bromide
AOS	Alpha Olefin Sulfonate
HLB	Hydrophilic-Lipophilic Balance
AES	Alcohol Ether Sulfonates
PPM	Parts Per Million