

**THE USE OF CONSERVATION OF  
MASS IN MODELING LATERAL  
BEHAVIOR IN MOVING WEBS**

**By**

**J. Brown  
Essex Systems  
USA**

**ABSTRACT**

Though conservation of mass has played a prominent role in modeling longitudinal tension, it has seen limited use in modeling problems where lateral behavior is important. This may be due to the fact that most lateral modeling has been done with methods borrowed from structural analysis. These have advantages. They are well-tested and provide closed-form solutions. However, they tend to be specific to particular structural problems and do not provide a conceptual framework in which conservation of mass can be incorporated. For example, when using beam theory to analyze deflection due to a misaligned roller, it isn't obvious that conservation of mass has anything to do with the problem. But, in fact, when viewed from the standpoint of two-dimensional elasticity theory, it can be shown that it is responsible for a key boundary condition of the beam theory model – the famous (to web handling specialists) zero moment condition.

Elasticity theory is the obvious candidate for two-dimensional and three-dimensional modeling. Unfortunately, it is viewed by many as a last choice because it requires the use of partial differential equations that can only be solved numerically. This is not the problem it once was. FEA software is now so fast and versatile that it can be used interactively. With turn-around times of only minutes, it can even be used as a tool for learning elasticity theory.

A method for using elasticity theory is described in a 2005 IWEB paper, "A New Method for Analyzing the Deformation and Lateral Translation of a Moving Web" [1]. It shows how to set up and solve a wide range of lateral behavior problems. A key boundary condition for the method, called the normal strain rule, relies on conservation of mass. A mathematical statement of this rule is,

$$\frac{V_2}{V_1} = \frac{1 + \varepsilon_2}{1 + \varepsilon_1}, \quad \{1\}$$

where the subscripts 1 and 2 refer to the upstream and downstream rollers, respectively, and  $V$  and  $\varepsilon$  refer to the velocities and strains at the point of entry to the rollers. This relationship is applied as a boundary condition to each increment of web width and can, therefore, model lateral non-uniformities in both the web and roller.

This paper will show that the normal strain rule is a special case of a more comprehensive concept that provides a framework for solving a broader scope of problems than contemplated in 2005, especially those in which the relaxed web is not flat. It will also introduce a computationally efficient method for implementing this concept by treating all webs, flat or otherwise, as membranes in a two-dimensional frame of reference.

To be of practical use to investigators, the concepts discussed here and in the 2005 paper [1] require the use of numerical analysis software to solve the partial differential equations. Adaptation of the mathematics to the requirements of a solver is not a trivial task. Therefore, in the hope of facilitating work by others in this area, I will make available the solver script for a misaligned roller to anyone who requests it.

## NOMENCLATURE

CD	Cross web direction
MD	Machine direction
$h$	Thickness (m)
$i, j, k$	Unit vector for $x, y, z$ coordinate system
$i_{\tilde{x}}, i_{\tilde{y}}, i_{\tilde{z}}$	Unit vectors for $\tilde{x}, \tilde{y}, \tilde{z}$ coordinate system
$Q$	Specific mass flow, kg/m/s
$R_{\alpha}$	Major radius of the torus (toroidal radius), m
$R_{\beta}$	Minor radius of the torus (poloidal radius), m
$R_o$	Radius of curvature of long side of cambered web, m
$V_o$	Circumferential velocity of long side of cambered web, m/s
$V_r$	Velocity of relaxed web in direction of $x$ -coordinate, m/s
$V_s$	Velocity of stressed web along curvilinear $\tilde{x}$ -coordinate, m/s
$u$	Displacement in $x$ -direction (or $\alpha$ -direction for the baggy web), m
$v$	Displacement in $y$ -direction (or for $\beta$ -direction for the baggy web), m
$w$	Displacement in $z$ -direction (or normal to surface for baggy web), m
$x, y, z$	Cartesian coordinates of relaxed web, m
$\tilde{x}, \tilde{y}, \tilde{z}$	Curvilinear coordinates of deformed web (under stress), m
$\alpha$	Major angle of torus (toroidal angle), radians
$\beta$	Minor angle of torus (poloidal angle), radians
$\varepsilon$	Strain
$\rho$	Density (kg/m <sup>3</sup> )
$\sigma$	Stress (N/m <sup>2</sup> )
$\psi$	Angle of $\tilde{x}$ coordinate relative to $x$ coordinate, radians

## Subscripts

$avg$	Indicates a cross-web average value
$d$	At downstream roller
$r$	Indicates relaxed (or reference) state of web
$s$	Indicates stressed (or current) state of web
$u$	At upstream roller
$x, y, z$	Cartesian coordinates of relaxed web

$\tilde{x}, \tilde{y}, \tilde{z}$	Coordinates of deformed web (under stress)
$\tilde{\alpha}, \tilde{\beta}, \tilde{R}$	Curvilinear coordinates of deformed baggy web

## HISTORY

The first known use of equation {1} was by none other than Osborne Reynolds in a brief paper [2] on belt drives. Judging from the literature, belt drives, during the 19<sup>th</sup> century, stirred a remarkable amount of controversy. One of the subjects of considerable debate was the origin of the phenomenon of creep. It had long been known that driver and driven pulleys don't have the speed relation one would expect from their relative diameters. The driven pulley always turns slower than the diameter ratio predicts. This is known as creep. Most early investigators believed it had something to do with friction. Reynolds correctly attributed it to the difference in strains of the belt as it entered and left a pulley. As a later investigator, would report in 1928 (Swift) [3], "the mechanics of belt action was meantime advanced by Osborne who, in 1874 showed that with an elastic driving belt there must inevitably be a loss of speed owing to the extension and contraction of the belt, and that this loss of speed must increase as the tension difference became greater." In that case, the subscripts in {1} applied to the tight and slack segments of the belt.

Shelton used the same relationship for another purpose in his 1986 paper "Dynamics of Web Tension Control with Velocity or Torque Control" [4]. In that context, he referred to it as the concept of transport of strain. This name was intended to emphasize the dependence of tension in any span on the tension in the one preceding it. The subscripts in that case refer to adjacent spans and the values of velocity and strain are understood to be average values.

## THE CONCEPTUAL FRAMEWORK

The following analysis is presented for a rectangular relaxed web. But, it will become obvious that it is also valid for a relaxed web that is a surface of revolution with orthogonal curvilinear coordinates, provided that one of the coordinates is aligned with the paths taken by points on the surface as it revolves about the axis of revolution. Among the surfaces that meet this requirement are: an annulus (cambered web), a cylinder (web on a roller) and a torus (baggy web).

In order to apply the principle of conservation of mass to a web handling problem, it is necessary to know the change in specific mass flow ( $kg/m^2-s$ ) at any location, as the web goes from the relaxed to the stressed state. That, in turn, requires understanding how three things change. These are: 1) the paths followed by web particles, 2) the cross sectional area through which the particles pass and 3) the density of the material. For a relaxed, uniform web, it is easy to calculate the mass flow. The paths may all be chosen to be parallel to one of the coordinate axes, such as  $x$ . The increment of cross sectional area will then be in the plane of the other two axes,  $y$  and  $z$  and the density can be determined in a static off-line measurement. After the web is deformed by stress, the situation is not so clear. The paths that were originally straight may become curved; the increments of cross sectional area become distorted and the density changes. Fortunately, it turns out that the solution to this problem fits hand-in-glove with nonlinear elasticity theory.

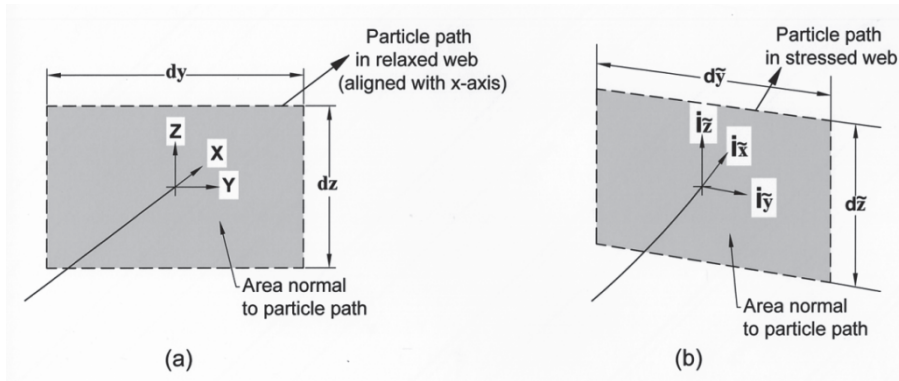

Figure 1 – Mapping mass flow in the relaxed web to mass flow in a stressed web.

**The Unique Role of Nonlinear Elasticity Theory in Relating Mass Flows in the Relaxed and Stressed Webs**

There are two types of nonlinear elasticity theory. One deals with nonlinear materials - those that exhibit either viscoelastic or plastic behavior. The other deals with nonlinear equations needed to characterize the geometric relations resulting from large deformations. It is geometric nonlinearity that will concern us here.

Web processes typically operate with strains that are small and therefore permit the use of Hook's law. However, small strains do not necessarily imply small deformations, particularly elastic rotations. An example would be a thin steel band that can be bent into a complete circle without exceeding the material's yield point. In web handling, a good example is the misaligned roller in which the rotation (in radians) of the downstream end is of the same order of magnitude as the strain. In this case, the MD tension interacts with the rotation in a way that significantly alters the amount of lateral bending. To account for these effects, nonlinear terms must be included in the equations of equilibrium<sup>1</sup>. There may be special cases where linear theory produces acceptable answers for large deformations, such as deflection of a cantilevered beam with no longitudinal stress. But, in general, linear theory is useless for web handling.

When using nonlinear elasticity theory, new coordinate lines, which are generally curved as illustrated in Figure 1, may be calculated for the web in its stressed state. These contain the points which, before deformation, were located on lines parallel to the corresponding coordinate axes  $x$ ,  $y$  and  $z$ . In the case of plane stress,  $z$  is assumed to be normal to the  $x$ - $y$  plane. For a two-dimensional problem, you can imagine that if a rectangular grid is inscribed on the object in the relaxed state, it then becomes a curvilinear coordinate system for the object after it is deformed by stress. The subscripts  $\tilde{x}$ ,  $\tilde{y}$  and  $\tilde{z}$  are used to indicate these curvilinear coordinates of the stressed web. The unit vectors representing the coordinate directions will be designated  $\tilde{i}_x$ ,  $\tilde{i}_y$  and  $\tilde{i}_z$ . If the strains are small, this new coordinate system can be considered to be mutually orthogonal and will generally be rotated relative to the  $x$ ,  $y$ , and  $z$  axes by an amount that will vary

---

<sup>1</sup> Beam theory for a misaligned roller also includes the effect of MD tension. But, it avoids nonlinearity by assuming that it is constant. This constant value can be interpreted as the cross-web average value. This, as Shelton demonstrated, works quite well for purposes of predicting overall lateral displacement.

depending on location. The orthogonality is not perfect. The angles between them will differ slightly from 90 degrees because of shear. However, the errors this discrepancy introduces into the calculation of stress and mass flow are on the order of one minus the cosine of the angle of shear and are thus second order effects. The strains in the directions of the deformed coordinate system will be represented as  $\varepsilon_{\bar{x}\bar{x}}$ ,  $\varepsilon_{\bar{y}\bar{y}}$  and  $\varepsilon_{\bar{z}\bar{z}}$ . Nonlinear elasticity theory makes it possible to calculate these strains as well as their directions.

If a solution process could be implemented using the deformed coordinates, the equations of equilibrium and strain equations would look exactly the same as in linear theory. However, this is not possible because the deformed coordinates are not known until the problem is solved. To get around this difficulty, all of the quantities that will appear in the solution must be expressed in terms of the original coordinates. For small strain theory, this is where the nonlinear terms come from. The small strain assumption is very important because large strain introduces nonlinearities that are an order of magnitude more difficult. Once the solution to the nonlinear equations is available, the orientation of the deformed coordinates (as a function location) can be calculated along with the values of stresses and strains that are aligned with them.

One more feature must be added to this picture. The web moves. And, although it is assumed to be static for purposes of elastic analysis, the motion plays an important role in establishing boundary conditions. In the relaxed state, one of the coordinate axes, which is assumed to be  $x$  in this discussion, is assumed to be aligned with the direction of motion. This means that every particle in the relaxed web will follow paths that are parallel to the  $x$ -axis and in the stressed web these same particles will follow paths that coincide with curved coordinate lines that are aligned with the unit vector  $i_{\bar{x}}$ .

*Furthermore, as a consequence of the effective orthogonality of  $i_{\bar{x}}$ ,  $i_{\bar{y}}$  and  $i_{\bar{z}}$ , any increment of area that is normal to the particle path in the relaxed web can, after it is deformed, be taken as normal to the path in the stressed web and therefore in the same plane as  $i_{\bar{y}}$  and  $i_{\bar{z}}$  at that point.*

We now have everything necessary to relate mass flow in the relaxed web to that in the stressed web.

Assume that the relaxed web is perfectly straight, is moving with velocity  $V_r$ , has a thickness  $h$  that does not vary with  $x$  and that it has a uniform density  $\rho_r$ .

### **Calculating the Mass Flows**

Now, referring to Figure 1, consider a small cross sectional area of the web in its relaxed state, normal to the direction of motion, with width  $dy$  and height  $h$ . The specific mass flow through this area will be.

$$Q_r = \frac{dm}{dt} = dy h V_r \rho_r \quad \{2\}$$

Before proceeding further, an important fact about mass flow in process lines should be noted. When a process line reaches a steady state of tension and motion, the law of conservation of mass requires that the mass flow per unit area along any given particle path be constant. Unless that were true, the mass in spans would be growing or

diminishing. That would alter tension or velocity and thus contradict the assumption of steady state<sup>2</sup>.

Now, we will assume that the relaxed web, described earlier, is exposed to the stresses of a process line. Depending on the condition of things such as rollers and nips, its lateral shape is changed. But in the steady state, presuming that the web remains in tension all along its length<sup>3</sup>, the elastic analysis presumes that this piece of web does not change in mass in going from the relaxed to the stressed state. So, it is logically consistent to assume that the specific mass flow rate at any point remains at the same value it had at the corresponding point in the relaxed web. This assumption does not limit the generality of the model. Once the overall scheme is made clear, it will be obvious how adjustments in the total mass flow rate affect results.

Thus, for the stressed web, the requirement that the specific mass flow rate at any point match the value at the corresponding location in the relaxed web means that the same mass per unit time must be passing through the deformed cross sectional area  $d\bar{y}d\bar{z}$ . And since,

$$d\bar{y} = dy(1 + \varepsilon_{yy}) \quad d\bar{z} = dz(1 + \varepsilon_{zz}) \quad d\bar{x} = dx(1 + \varepsilon_{xx}) \quad \{3\}$$

Then,

$$Q_s = \frac{dm}{dt} = dy(1 + \varepsilon_{yy})h(1 + \varepsilon_{zz})V_s \rho_s \quad \{4\}$$

There is one more point to be considered. Since most web materials have a Poisson ratio of less than 0.5, their density changes with stress. If density of the stressed web is represented by  $\rho_s$ , then,

$$\rho_s = \frac{\rho_r}{(1 + \varepsilon_{xx})(1 + \varepsilon_{yy})(1 + \varepsilon_{zz})} \quad \{5\}$$

Substituting {5} in {4} yields,

$$Q_s = \frac{dm}{dt} = \frac{V_s}{1 + \varepsilon_{xx}} dy h \rho_r \quad \{6\}$$

---

<sup>2</sup> There is always a single location where the line speed serves as a reference for all other points in the process. This is known as the master speed reference. When speed is changed at this point, the operator is actually setting the mass flow reference. By forcing each tension zone to adjust its speed in proportion to this signal, the tension control system keeps the total mass flow rate in each zone matched to the total mass flow rate at the reference location and this, in turn, minimizes tension disturbances.

<sup>3</sup> Since webs usually can't support compressive stress, there could be localized areas of MD slackness where part of the web buckles out of plane to accommodate the mass flow. These situations don't alter the argument, provided they aren't growing or shrinking.

Finally, equating the mass flows in {2} and {6} ,

$$V_r = \frac{V_s}{(1 + \varepsilon_{\bar{x}\bar{x}})} \quad \{7\}$$

Thus, at any point on a web that is uniform along its length and in a steady state of motion, the velocity in the relaxed web  $V_r$ , is equal to the velocity in the stressed web  $V_s$  divided by  $(1 + \varepsilon_{\bar{x}\bar{x}})$ , the strain  $\varepsilon_{\bar{x}\bar{x}}$  being measured in the same direction as the velocity. In the rest of this discussion I will refer to this as the Velocity-Strain equation.

It is obvious that if {7} applies point-wise across the web, the cross-web average values of the variables will have the same relationship.

$$V_{ravg} = \frac{V_{savg}}{1 + \varepsilon_{\bar{x}\bar{x}avg}} \quad \{8\}$$

Another important point to note is that there is nothing in the derivation of equation {7} that excludes the possibility of lateral variations in density or thickness of the web. Although, it is possible that large variations in thickness may need to be treated like variation in roller diameter.

On casual examination, equation {7} seems trivial. However, its power lies in 1) its ability to incorporate the cross web variation in  $V_s$ , imposed by rollers and nips into the elastic analysis – as, for example, in the case of a concave roller and 2) its ability to also account for the behavior of webs that are not straight or flat in their relaxed state where  $V_r$  will vary with lateral position. The implications of these facts will be explored later.

In most problems, the average values  $\varepsilon_{\bar{x}\bar{x}avg}$  and  $V_{savg}$  are used to calculate an average value for  $V_r$ . Then, the functional dependence of  $V_s$  and/or  $V_r$  on lateral position is used to calculate corresponding values of  $\varepsilon_{\bar{x}\bar{x}}$  that, when averaged will match  $\varepsilon_{\bar{x}\bar{x}avg}$ . This will be illustrated later.

It should also be apparent that the ratio of  $V_r$  to  $V_s$  at a particular cross web position won't change with line speed alone. It only changes with tension.

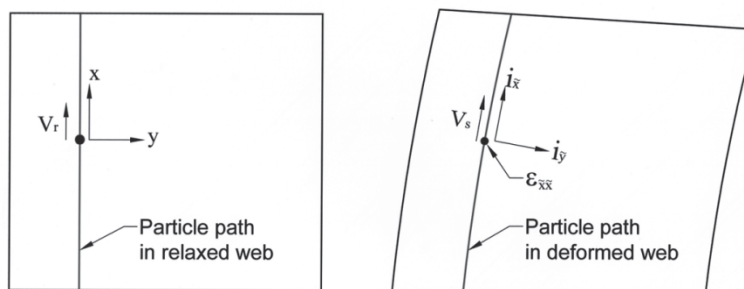

Figure 2 – Geometric relationships in the Velocity-Strain equation

The annotated photo in Figure 3 shows a latex<sup>4</sup> web in a steady state condition at a misaligned roller. Strains and displacements have been made unrealistically large so that their effects are visible. Since the small strain assumption has been violated, this is only a qualitative demonstration. Even so, the essential features of the Velocity-Strain equation can be seen. The black lines were applied to the relaxed web before taking the photo. It was a uniform square grid. The white, semitransparent bands, arrows and other annotations were added with Photoshop. Comparing the relative lengths of the white bands, it is clear that the lower edge of the web is longer than the top, indicating that it is stretched more.

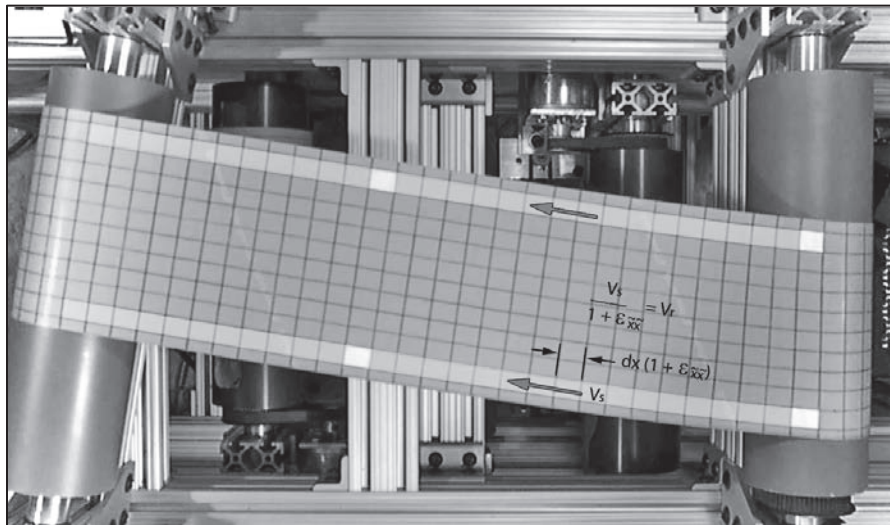

Figure 3 – Qualitative Demonstration of the Velocity-Strain equation.

At the downstream end, the web must match the circumferential velocity of the roller and is therefore moving at constant speed at every point across its width. There is no evidence of distortion there. All of the lateral bending is occurring in the vicinity of the upstream roller, causing higher MD stress at the bottom edge than at the top. The stress variation from edge to edge is evident in the spacing of the vertical grid lines. They are farther apart at the bottom than the top. So, it is clear that in the vicinity of the upstream roller, the web is moving faster at the bottom edge than at the top, in accordance with the Velocity-Strain equation.

### The Normal Strain Rule

The Normal Strain rule in the 2005 paper is a special case of the Velocity-Strain equation. Along any particular particle path,  $V_r$  is constant. So, equation {7} can be applied once at the entry to a roller where the velocity is  $V_d$  and strain is  $\epsilon_d$  and then again on the same particle path at the entry to the upstream roller where the velocity is  $V_u$  and

---

<sup>4</sup> Latex has two advantages for demonstrations. It can tolerate very large strains. And it has a Poisson ratio close to 0.5, so that density changes due to strain are eliminated from consideration.



the strain is  $\varepsilon_u$ . And because of the normal entry rule, both the strains and the velocities are in the direction of the  $\tilde{x}$ -coordinate. Then, since  $V_r$  is the same in both cases,

$$\frac{V_u}{V_d} = \frac{1 + \varepsilon_u}{1 + \varepsilon_d}. \quad \{9\}$$

Before proceeding to a discussion of non-uniform webs, the nonlinear equations of elasticity will be summarized.

### THE NONLINEAR EQUATIONS OF ELASTICITY

In 1948 V. V. Novozhilov published a wonderful monograph [5] on nonlinear elasticity. In it, he derives the nonlinear elasticity equations without the use of tensors and shows how they may be simplified for specific kinds of problems. Although, his motivation seems to have been mainly pedagogical, his results provide starting points for two computationally efficient models that are ideally suited for web handling. The first version is suitable for problems involving the kinds of large out-of-plane rotations that can occur in webs that are twisted, baggy or passing over curved bars. The second, simpler version is for problems where the elastic rotations are of the same order as the strains. This is typically useful for web handling problems that do not involve out-of-plane motion, or for which out-of-plane rotations are very small.

The first step in getting to the desired equations is to summarize two versions of geometrically nonlinear equations of equilibrium in three dimensions, as presented by Novozhilov. These are the equations for,

- Small strains and large rotations.
- Small strains and small rotations.

In the following discussion, these are modified to model non-planar membranes in a two-dimensional frame of reference.

The variables  $u$ ,  $v$  and  $w$  represent the displacements due to strain, referred to the coordinates  $x$ ,  $y$  and  $z$ . As indicated earlier, the subscripts  $\tilde{x}$ ,  $\tilde{y}$  and  $\tilde{z}$  indicate the corresponding curvilinear coordinates in the stressed web. The symbols  $\sigma$  and  $\varepsilon$  will represent stress and strain. Subscripts will indicate the coordinates to which they are referred.

For purposes that will become apparent later on (curvilinear coordinates), it is useful to adopt the following notation.

$$e_{xx} = \frac{\partial u}{\partial x}, \quad e_{yy} = \frac{\partial v}{\partial y}, \quad e_{zz} = \frac{\partial w}{\partial z} \quad \{10\}$$

$$e_{xy} = \frac{\partial u}{\partial y} + \frac{\partial v}{\partial x}, \quad e_{xz} = \frac{\partial u}{\partial z} + \frac{\partial w}{\partial x}, \quad e_{yz} = \frac{\partial v}{\partial z} + \frac{\partial w}{\partial y} \quad \{11\}$$

$$\omega_x = \frac{1}{2} \left( \frac{\partial w}{\partial y} - \frac{\partial v}{\partial z} \right), \quad \omega_y = \frac{1}{2} \left( \frac{\partial u}{\partial z} - \frac{\partial w}{\partial x} \right), \quad \omega_z = \frac{1}{2} \left( \frac{\partial v}{\partial x} - \frac{\partial u}{\partial y} \right) \quad \{12\}$$

The parameters  $\omega$  in {12} are involved in characterizing the rotation of an arbitrary infinitesimal element. When they are zero, the average rotation is zero.

### **The Equilibrium Equations for Small Strains and Large Rotations**

The first of three scalar equilibrium equations for small strains and large rotations, taken directly from Novozhilov, is shown below.

$$\begin{aligned} & \frac{\partial}{\partial x} \left[ (1 + e_{xx}) \sigma_{\tilde{x}\tilde{x}} + \left( \frac{1}{2} e_{xy} - \omega_z \right) \sigma_{\tilde{xy}} + \left( \frac{1}{2} e_{xz} + \omega_y \right) \sigma_{\tilde{xz}} \right] \\ & + \frac{\partial}{\partial y} \left[ (1 + e_{xx}) \sigma_{\tilde{yx}} + \left( \frac{1}{2} e_{xy} - \omega_z \right) \sigma_{\tilde{yy}} + \left( \frac{1}{2} e_{xz} + \omega_y \right) \sigma_{\tilde{yz}} \right] \quad x\text{-direction} \quad \{13\} \\ & + \frac{\partial}{\partial z} \left[ (1 + e_{xx}) \sigma_{\tilde{zx}} + \left( \frac{1}{2} e_{xy} - \omega_z \right) \sigma_{\tilde{zy}} + \left( \frac{1}{2} e_{xz} + \omega_y \right) \sigma_{\tilde{zz}} \right] = 0 \end{aligned}$$

The equations for the  $y$  and  $z$  directions can be written out by permuting the subscripts.

As in linear theory,  $\sigma_{ij} = \sigma_{ji}$ .

In the language of continuum mechanics, the sums of terms inside the brackets represent the 1<sup>st</sup> Piola-Kirchhoff stresses. The quantities  $\sigma$  with tildes over the subscripts are Cauchy stresses – the true stresses that are aligned with the deformed coordinates in the stressed web.

### **Modifications for Representing a Membrane in a 2D Frame of Reference**

The 3D equilibrium equations, when applied to thin webs, present many challenges for FEA solvers. Many of them can be avoided by using a technique very similar to that used by the early pioneers of structural analysis to model the combined effects of surface loading, bending moments and in-plane stresses on thin plates. This is a 2D model, with no  $z$ -axis terms other than out-of-plane displacement [6].

A straightforward approach to deriving such a model is to start with the 3D equations and eliminate all of the derivatives, stresses and shears involving the  $z$ -axis. Doing this removes the effects of bending stiffness. But, this has negligible effect on accuracy for a wide class of problems in which the web is treated as a perfectly flexible membrane. Only the variable  $w$ , representing the out-of plane displacement is retained. In this way, a 2D coordinate system can be used to define the relaxed web. But, information on the  $w$  displacement is retained. The equilibrium equations then become,

$$\begin{aligned} & \frac{\partial}{\partial x} \left[ (1 + e_{xx}) \sigma_{\tilde{x}\tilde{x}} + \left( \frac{1}{2} e_{xy} - \omega_z \right) \sigma_{\tilde{xy}} \right] \\ & + \frac{\partial}{\partial y} \left[ (1 + e_{xx}) \sigma_{\tilde{xy}} + \left( \frac{1}{2} e_{xy} - \omega_z \right) \sigma_{\tilde{yy}} \right] = 0 \end{aligned} \quad \{14\}$$

$$\begin{aligned} & \frac{\partial}{\partial x} \left[ \left( \frac{1}{2} e_{xy} + \omega_z \right) \sigma_{\tilde{x}\tilde{x}} + (1 + e_{yy}) \sigma_{\tilde{xy}} \right] \\ & + \frac{\partial}{\partial y} \left[ \left( \frac{1}{2} e_{xy} + \omega_z \right) \sigma_{\tilde{xy}} + (1 + e_{yy}) \sigma_{\tilde{yy}} \right] = 0 \end{aligned} \quad \{15\}$$

$$\frac{\partial}{\partial x} \left[ \frac{\partial w}{\partial x} \sigma_{\tilde{x}\tilde{x}} + \frac{\partial w}{\partial y} \sigma_{\tilde{xy}} \right] + \frac{\partial}{\partial y} \left[ \frac{\partial w}{\partial x} \sigma_{\tilde{xy}} + \frac{\partial w}{\partial y} \sigma_{\tilde{yy}} \right] = 0 \quad \{16\}$$

This will be called the 2D +  $w$  membrane model. So long as the web is very thin and flexible, these equations are valid for large out-of-plane displacements. The main limitation is solution stability. Compressive stresses cause the model to have multiple solutions. Essentially, wrinkles try to form. And without bending stiffness, the solution oscillates between many possible shapes. This can be controlled to some extent by adjusting the cell size of the FEA mesh or by imposing special constraints on  $w$ .

It's instructive to expand the derivatives in equation {16} and examine the individual terms.

$$\begin{aligned} & \left[ \frac{\partial^2 w}{\partial x^2} \sigma_{\tilde{x}\tilde{x}} + 2 \frac{\partial^2 w}{\partial x \partial y} \sigma_{\tilde{x}\tilde{y}} + \frac{\partial^2 w}{\partial y^2} \sigma_{\tilde{y}\tilde{y}} \right] \\ & + \left[ \frac{\partial w}{\partial x} \frac{\partial \sigma_{\tilde{x}\tilde{x}}}{\partial x} + \frac{\partial w}{\partial y} \frac{\partial \sigma_{\tilde{x}\tilde{y}}}{\partial x} + \frac{\partial w}{\partial x} \frac{\partial \sigma_{\tilde{x}\tilde{y}}}{\partial y} + \frac{\partial w}{\partial y} \frac{\partial \sigma_{\tilde{y}\tilde{y}}}{\partial y} \right] = 0 \end{aligned} \quad \{17\}$$

The terms in the first set of brackets in {17} are exactly those derived by von Karman as part of his large-deflection plate analysis. They represent the out-of-plane stresses due to the interaction of in-plane stresses with surface curvature. The terms in the second set of brackets are the contributions to out-of-plane stresses due to interaction of spatial rate of change of the in-plane stresses with the slope of the web surface. In plate analysis, the second set of terms is not significant because the out of plane forces due to slopes are small compared to the effects of curvature plus bending moments. In the case of webs, however, the slopes can be large - for example as in the case of a twisted or baggy web.

For problems with no out-of-plane displacements (plane stress), only the first two equations are needed ( $w = 0$ ). Even with compressive stress, these models tend to be well-behaved and converge very quickly.

### **Strain Definitions for Small Strain and Large Rotations**

Since they are interpreted as strains in the plane of a membrane, only three strains are required. These are known in continuum mechanics as Green-Lagrange strains [6].

$$\text{Strain along } i_{\tilde{x}} \quad \varepsilon_{\tilde{x}\tilde{x}} = \frac{\partial u}{\partial x} + \frac{1}{2} \left[ \left( \frac{\partial u}{\partial x} \right)^2 + \left( \frac{\partial v}{\partial x} \right)^2 + \left( \frac{\partial w}{\partial x} \right)^2 \right] \quad \{18\}$$

$$\text{Strain along } i_{\tilde{y}} \quad \varepsilon_{\tilde{y}\tilde{y}} = \frac{\partial v}{\partial y} + \frac{1}{2} \left[ \left( \frac{\partial v}{\partial y} \right)^2 + \left( \frac{\partial u}{\partial y} \right)^2 + \left( \frac{\partial w}{\partial y} \right)^2 \right] \quad \{19\}$$

$$\text{Shear strain in plane } i_{\tilde{x}} - i_{\tilde{y}} \quad \varepsilon_{\tilde{x}\tilde{y}} = \frac{\partial u}{\partial y} + \frac{\partial v}{\partial x} + \frac{\partial u}{\partial x} \frac{\partial u}{\partial y} + \frac{\partial v}{\partial x} \frac{\partial v}{\partial y} + \frac{\partial w}{\partial x} \frac{\partial w}{\partial y} \quad \{20\}$$

Equations {18} through {20} look horribly complicated. But, a good FEA solver can easily accommodate them and their physical interpretation is quite simple. They are the strains that are tangent to the surface of the membrane and aligned with the deformed coordinates  $\tilde{x}$  and  $\tilde{y}$ .

For problems of plane stress, the terms involving  $w$  are dropped.

It may be helpful to some to see how these equations work in a simple case. Suppose a 0.61 by 0.61 m (24 by 24 inch) sheet, 0.0254 mm (.001 inch) thick with a modulus of

689.5 MPa (100 kpsi) is oriented in the  $x$ - $y$  plane and stretched in the  $y$ -direction with a uniform tension of 1000 psi. Then, the sheet is subjected to an out-of-plane, rigid-body rotation of 30 degrees, while maintaining the tension. The axis of rotation is parallel to the  $x$ -axis and midway down the sheet. The following table shows calculated values in the center of the sheet for the partial derivatives applicable to equation {19} for the two cases.

	$\frac{\partial v}{\partial y}$	$\frac{\partial u}{\partial y}$	$\frac{\partial w}{\partial y}$
Sheet horizontal	0.009 9505	0	0
Sheet rotated 30 deg	- 0.125375	0	0.505 007

$$\text{Sheet horizontal} \quad \varepsilon_{\bar{y}\bar{y}} = 0.0099505 + \frac{1}{2} \left[ (0.0099505)^2 + 0 + 0 \right] = 0.0100$$

Sheet rotated 30 deg

$$\varepsilon_{\bar{y}\bar{y}} = -0.125375 + \frac{1}{2} \left[ (-0.125375)^2 + 0 + (0.505007)^2 \right] = 0.0100$$

### **Small Strains and Small Rotations**

When rotations are small and of the same order of magnitude as the strains, the equations of equilibrium and strain can be simplified.

The equations of equilibrium become,

$$\frac{\partial}{\partial x} \left[ \sigma_{\bar{x}\bar{x}} - \omega_z \sigma_{\bar{x}\bar{y}} \right] + \frac{\partial}{\partial y} \left[ \sigma_{\bar{x}\bar{y}} - \omega_z \sigma_{\bar{y}\bar{y}} \right] = 0 \quad \{21\}$$

$$\frac{\partial}{\partial x} \left[ \sigma_{\bar{x}\bar{y}} + \omega_z \sigma_{\bar{x}\bar{x}} \right] + \frac{\partial}{\partial y} \left[ \sigma_{\bar{y}\bar{y}} + \omega_z \sigma_{\bar{x}\bar{y}} \right] = 0 \quad \{22\}$$

$$\frac{\partial}{\partial x} \left[ \frac{\partial w}{\partial x} \sigma_{\bar{x}\bar{x}} + \frac{\partial w}{\partial y} \sigma_{\bar{x}\bar{y}} \right] + \frac{\partial}{\partial y} \left[ \frac{\partial w}{\partial x} \sigma_{\bar{x}\bar{y}} + \frac{\partial w}{\partial y} \sigma_{\bar{y}\bar{y}} \right] = 0 \quad \{23\}$$

The equations of strain become,

$$\varepsilon_{\bar{x}\bar{x}} \approx \frac{\partial u}{\partial x} + \frac{1}{2} \left[ \left( \frac{1}{2} \frac{\partial w}{\partial x} \right)^2 + (\omega_z)^2 \right] \quad \{24\}$$

$$\varepsilon_{\bar{y}\bar{y}} \approx \frac{\partial v}{\partial y} + \frac{1}{2} \left[ \left( \frac{1}{2} \frac{\partial w}{\partial y} \right)^2 + (\omega_z)^2 \right] \quad \{25\}$$

$$\varepsilon_{\bar{x}\bar{y}} \approx \frac{\partial v}{\partial x} + \frac{\partial u}{\partial y} + \frac{\partial w}{\partial y} \frac{\partial w}{\partial x} \quad \{26\}$$

As in the case of large rotations, plane stress problems require only equations {21} and {22}. And in the strain equations, all of the terms involving  $w$  are dropped.

### Stress Definitions

The stresses,  $\sigma_{\tilde{x}\tilde{x}}$ ,  $\sigma_{\tilde{y}\tilde{y}}$  and  $\sigma_{\tilde{x}\tilde{y}}$  for both the large and small rotation models are simply Hook's law for plane stress, except they are interpreted as being in the plane of the membrane and aligned with the deformed coordinates  $\tilde{x}$  and  $\tilde{y}$ .

$$\text{Stress along } i_{\tilde{x}} \quad \sigma_{\tilde{x}\tilde{x}} = \frac{E}{1-\mu^2} (\varepsilon_{\tilde{x}\tilde{x}} + \mu\varepsilon_{\tilde{y}\tilde{y}}) \quad \{27\}$$

$$\text{Stress along } i_{\tilde{y}} \quad \sigma_{\tilde{y}\tilde{y}} = \frac{E}{1-\mu^2} (\varepsilon_{\tilde{y}\tilde{y}} + \mu\varepsilon_{\tilde{x}\tilde{x}}) \quad \{28\}$$

$$\text{Shear stress in plane } i_{\tilde{x}} - i_{\tilde{y}} \quad \sigma_{\tilde{x}\tilde{y}} = \frac{E}{2(1+\mu)} (\varepsilon_{\tilde{x}\tilde{y}}) \quad \{29\}$$

### Relationship of the Deformed Coordinates $\tilde{x}$ , $\tilde{y}$ and $\tilde{z}$ to Those of the Relaxed Web

Direction cosines of the unit vectors  $i_{\tilde{x}}$ ,  $i_{\tilde{y}}$  and  $i_{\tilde{z}}$ , of the deformed coordinates  $\tilde{x}$ ,  $\tilde{y}$  and  $\tilde{z}$  in relation to the coordinates of the relaxed web are shown in Table 1.

The values of  $E_x$ ,  $E_y$  and  $E_z$  in the table entries are,

$$E_x = \sqrt{1+2\varepsilon_{xx}} - 1, \quad E_y = \sqrt{1+2\varepsilon_{yy}} - 1, \quad E_z = \sqrt{1+2\varepsilon_{zz}} - 1 \quad \{30\}$$

	$i_{\tilde{x}}$	$i_{\tilde{y}}$	$i_{\tilde{z}}$
x	$\frac{1+e_{xx}}{1+E_x}$	$\frac{\left(\frac{1}{2}e_{xy} - \omega_z\right)}{1+E_y}$	$\frac{\left(\frac{1}{2}e_{xz} + \omega_y\right)}{1+E_z}$
y	$\frac{\left(\frac{1}{2}e_{xy} + \omega_z\right)}{1+E_x}$	$\frac{1+e_{yy}}{1+E_y}$	$\frac{\left(\frac{1}{2}e_{yz} - \omega_x\right)}{1+E_z}$
z	$\frac{\left(\frac{1}{2}e_{xz} - \omega_y\right)}{1+E_x}$	$\frac{\left(\frac{1}{2}e_{yz} + \omega_x\right)}{1+E_y}$	$\frac{1+e_{zz}}{1+E_z}$

Table 1 – Direction cosines of the deformed coordinates

### Normal Entry Angle

Application of the normal entry rule requires knowing the angle  $\psi$  between the paths of the particles in the stressed web and the  $x$  coordinate, in other words, the angle between the  $x$  and  $\tilde{x}$  coordinates. The values in Table 1 can be used to express the unit vector  $i_{\tilde{x}}$  in terms of the unit vectors  $i$  and  $j$  of the  $x$  and  $y$  coordinates as,

$$i_{\bar{x}} = i \frac{1 + e_{xx}}{1 + E_x} + j \frac{\frac{1}{2} e_{xy} + \omega_z}{1 + E_x} \quad \{31\}$$

And the tangent of the angle  $\psi$  is,

$$\tan(\psi) = \frac{\frac{1}{2} e_{xy} + \omega_z}{1 + e_{xx}} = \frac{\frac{\partial v}{\partial x}}{1 + e_{xx}} \quad \{32\}$$

The same relationship was derived by different means in the 2005 paper [1].

## BAGGY WEB

An initial objective for this paper was to describe a conceptual framework for “thinking” about baggy webs. Writing about the subject stimulated new ideas that led to a complete working model. The key to the model is to define an appropriate natural shape for the relaxed web that makes the span geometry independent of time. A torus is a good candidate.

### Virtues of a Torus

A baggy web is, by definition, not flat in its relaxed state. The most common forms of bagginess consist of MD lanes that have become elongated during processing. There are many ways this can happen. A common cause is the formation of circumferential ridges in wound rolls due to non-uniformity in the sheet thickness profile (gauge bands). Another source might be an imperfect nip drive that produces a non-uniform MD velocity profile. If one thinks about these causes, it seems reasonable to postulate that the natural, relaxed shape of such webs - one that would leave them free of wrinkles or stress - would generally be toroidal in nature.

Furthermore, a torus meets the requirement for the Velocity-Strain equation that it be a surface of revolution with orthogonal curvilinear coordinates, and that one of the coordinates be aligned with the paths taken by points on the surface as it revolves about the axis of revolution.

The defining equations for a torus are:

$$z = (R_\alpha + R_\beta \cos(\beta)) \cos(\alpha), \quad x = (R_\alpha + R_\beta \cos(\beta)) \sin(\alpha), \quad y = R_\beta \sin(\beta) \quad \{33\}$$

An idealized example is shown in Figure 5 – exaggerated for sake of illustration. It might have resulted from a barrel-shaped wound roll. So, it is shorter at the edges than the center and is assumed to be moving in the  $+\alpha$  direction by rotating about the  $y$ -axis.

A torus is a particularly useful shape because it has all three of the basic types of curved surfaces [7]. Surfaces are classified on the basis of curvatures of the principal curves passing through a given point. If, for a given point on the surface, the centers of curvature of both these curves are on the same side of the surface, it is said to be elliptic there. If they are on opposite sides that, spot is called hyperbolic and if one of them is zero, it is parabolic. In the case of a torus, the principal curves are the lines traced by the point of the arrow labeled  $R_b$  in Figure 5 by holding  $\beta$  constant and varying  $\alpha$  and then by holding  $\alpha$  constant and varying  $\beta$ . At any point on the torus of Figure 5 for which  $-\pi/2 < \beta$

$< \pi/2$  the surface is elliptic. At any point on a line defined by  $\beta = \pm\pi/2$ , the surface is parabolic. And at any point for which  $\pi/2 < \beta < -\pi/2$  the surface is hyperbolic.

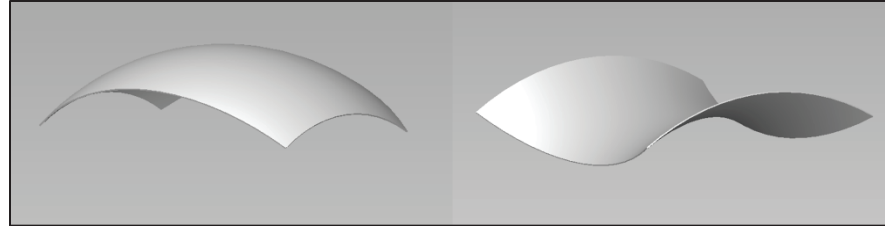

Elliptic surface

Hyperbolic surface

Figure 4 – Two fundamentally different curvatures for baggy webs

All points on the surface in Figure 5 are elliptic. As a consequence, both edges are shorter than the centerline. A web that has edges longer than the centerline can be modeled by selecting a hyperbolic segment from the inside surface of the torus. For a laterally-symmetric web, this is conveniently done by reversing the sign of  $R_\beta$  in the defining equations {33}. A web that combines camber and bagginess (hyperbolic on one half and elliptic on the other) could be modeled by locating the centerline where  $\beta = \pm\pi/2$ . Only symmetrically-elliptic and symmetrically-hyperbolic cases will be analyzed here.

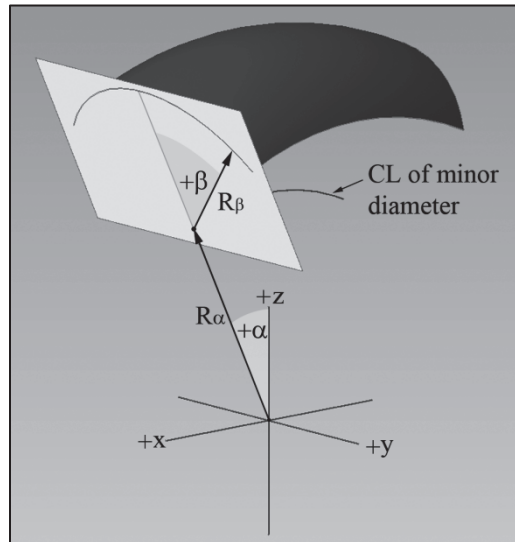

Figure 5 – A Section of a Torus

There are other geometries that might be possible by modifying a toroidal segment. Corrugations could be created by making  $R_\beta$  a sinusoidal function of  $\beta$ . Another possibility is a combination of a cylindrical surface (a torus with  $R_\beta = \infty$ ) and a Gaussian function to simulate a single baggy lane.

### Velocity-Strain Equation for a Torus

The normal strain boundary condition can be immediately calculated from a consideration of the geometry of the torus illustrated in Figure 5.

If  $V_o$  is the tangential velocity in the  $\alpha$ -direction when  $\beta$  is zero, then the velocity  $V_r$ , as the surface rotates about the  $y$  axis, will be,

$$V_r = V_o \frac{R_\alpha + R_\beta \cos(\beta)}{R_\alpha + R_\beta} \quad \{34\}$$

Substituting {34} into the Velocity-Strain equation to find the normal strain at the downstream roller,

$$\varepsilon_{\tilde{\alpha}\tilde{\alpha}bndry} = \frac{V_s}{V_o} \frac{(R_\alpha + R_\beta)}{(R_\alpha + R_\beta \cos(\beta))} - 1 \quad \{35\}$$

where it is assumed that the downstream roller has a surface velocity of  $V_s$  and the web has been pulled flat onto it with good traction. An important condition occurs when  $V_s/V_o = 1$ . Then, the strain will be zero at the center of the web.

If a target value for the average strain is specified, the following procedure can be used to find  $\varepsilon_{\tilde{\alpha}\tilde{\alpha}}$ . First, expression {35} is integrated to find  $\varepsilon_{\tilde{\alpha}\tilde{\alpha}avg}$ .

$$\varepsilon_{\tilde{\alpha}\tilde{\alpha}avg} = 4 \frac{V_s}{V_o} \left( \frac{R_\alpha - R_\beta}{R_\alpha + R_\beta} \right)^{\frac{1}{2}} \tan^{-1} \left( \tan \left( \frac{\beta_{max}}{4} \right) \left( \frac{R_\alpha - R_\beta}{R_\alpha + R_\beta} \right)^{\frac{1}{2}} \right) - 1 \quad \{36\}$$

This expression is then solved for the value of  $V_s/V_o$  which is used in expression {35} to calculate the normal strain profile. Note: {36} is valid only if  $R_\alpha > R_\beta$ .

### Curvilinear Coordinates

In order to apply the 2D +  $w$  membrane model to something like Figure 5, a mathematical transformation is needed that will “flatten” it for purposes of calculation and then permit “unflattening” the results. This is provided by curvilinear coordinates. If such a system is fitted to the surface of the torus, it is possible to transform the problem so that, for purposes of FEA analysis, the relaxed shape can be treated as though there is no  $z$ -axis and the boundaries will form a rectangle in the  $x$ - $y$  plane. For a torus, such a system can be created by choosing  $\alpha$  and  $\beta$  as the new coordinates.  $R_\beta$  would be the third coordinate in a full 3D model. Since these define the lines of principal curvature for a torus, orthogonality of the coordinates is assured. If a displacement variable  $w$  is defined in this context, it is interpreted as the distance along a normal to the surface (in the direction of  $R_\beta$  for the relaxed web). The surface itself is at  $w = 0$ . The displacements in the  $\alpha$  and  $\beta$  directions will be  $u$  and  $v$ , respectively (in units of distance, not angle).

The 2D +  $w$  membrane model with curvilinear coordinates is closely related to the membrane theory of shells [8], except that it can accommodate large displacements and rotations. The method for transformation to curvilinear coordinates is covered in numerous texts. The following results for nonlinear elasticity are based on a method outlined by Novozhilov [5].



### The 2D + w Model in Toroidal Coordinates

The Lamé coefficients for a torus are:

$$H_\alpha = R_\alpha + R_\beta \cos(\beta), \quad H_\beta = R_\beta, \quad H_R = 1 \quad \{37\}$$

The parameters corresponding to  $e_{xx}$ ,  $e_{yy}$ ,  $e_{xy}$ ,  $e_{xz}$ ,  $e_{yz}$ ,  $\omega_x$ ,  $\omega_y$  and  $\omega_z$  are:

$$e_{\alpha\alpha} = \frac{1}{H_\alpha} \left( \frac{\partial u}{\partial \alpha} - v \sin(\beta) + w \cos(\beta) \right) \quad \{38\}$$

$$e_{\beta\beta} = \frac{1}{H_\beta} \left( \frac{\partial v}{\partial \beta} + w \right) \quad \{39\}$$

$$e_{\alpha\beta} = \frac{1}{H_\alpha} \left( \frac{\partial v}{\partial \alpha} + u \sin(\beta) \right) + \frac{1}{H_\beta} \frac{\partial u}{\partial \beta} \quad \{40\}$$

$$e_{\alpha R} = \frac{1}{H_\alpha} \left( \frac{\partial w}{\partial \alpha} - u \cos(\beta) \right) \quad \{41\}$$

$$e_{\beta R} = \frac{1}{H_\beta} \left( \frac{\partial w}{\partial \beta} - v \right) \quad \{42\}$$

$$\omega_\alpha = \frac{1}{2H_\beta} \left( \frac{\partial w}{\partial \beta} - v \right) \quad \{43\}$$

$$\omega_\beta = \frac{1}{2H_\alpha} \left( -\frac{\partial w}{\partial \alpha} + u \cos(\beta) \right) \quad \{44\}$$

$$\omega_R = \frac{1}{2} \left[ \frac{1}{H_\alpha} \left( \frac{\partial v}{\partial \alpha} + u \sin(\beta) \right) - \frac{1}{H_\beta} \frac{\partial u}{\partial \beta} \right] \quad \{45\}$$

The strains corresponding to  $\varepsilon_{\bar{x}\bar{x}}$ ,  $\varepsilon_{\bar{y}\bar{y}}$  and  $\varepsilon_{\bar{x}\bar{y}}$  are:

$$\varepsilon_{\bar{\alpha}\bar{\alpha}} = e_{\alpha\alpha} + \frac{1}{2} \left[ e_{\alpha\alpha}^2 + \left( \frac{1}{2} e_{\alpha\beta} + \omega_R \right)^2 + \left( \frac{1}{2} e_{\alpha R} - \omega_\beta \right)^2 \right] \quad \{46\}$$

$$\varepsilon_{\bar{\beta}\bar{\beta}} = e_{\beta\beta} + \frac{1}{2} \left[ e_{\beta\beta}^2 + \left( \frac{1}{2} e_{\alpha\beta} - \omega_R \right)^2 + \left( \frac{1}{2} e_{\beta R} + \omega_\alpha \right)^2 \right] \quad \{47\}$$

$$\varepsilon_{\bar{\alpha}\bar{\beta}} = e_{\alpha\beta} + e_{\alpha\alpha} \left( \frac{1}{2} e_{\alpha\beta} - \omega_R \right) + e_{\beta\beta} \left( \frac{1}{2} e_{\alpha\beta} + \omega_R \right) + \left( \frac{1}{2} e_{\alpha R} - \omega_\beta \right) \left( \frac{1}{2} e_{\beta R} + \omega_\alpha \right) \quad \{48\}$$

The equations of equilibrium for the  $\alpha$ ,  $\beta$ , and  $R$  directions are, in respective order:

$$\frac{1}{H_\alpha H_\beta} \left[ \frac{\partial}{\partial \alpha} \left( H_\beta \overline{a_\alpha a_\alpha} \right) + \frac{\partial}{\partial \beta} \left( H_\alpha \overline{a_\beta a_\alpha} \right) \right] - \left( \frac{\sin(\beta)}{H_\alpha} \right) \overline{a_\alpha a_\beta} + \left( \frac{\cos(\beta)}{H_\alpha} \right) \overline{a_\alpha a_R} = 0 \quad \{49\}$$

$$\frac{1}{H_\alpha H_\beta} \left[ \frac{\partial}{\partial \alpha} (H_\beta \overline{a_\alpha a_\beta}) + \frac{\partial}{\partial \beta} (H_\alpha \overline{a_\beta a_\alpha}) \right] + \frac{1}{H_\beta} \overline{a_\beta a_R} + \frac{\sin(\beta)}{H_\alpha} \overline{a_\alpha a_\alpha} = 0 \quad \{50\}$$

$$\frac{1}{H_\alpha H_\beta} \left[ \frac{\partial}{\partial \alpha} (H_\beta \overline{a_\alpha a_R}) + \frac{\partial}{\partial \beta} (H_\alpha \overline{a_\beta a_R}) \right] + \frac{H_\beta \sin(\beta)}{H_\alpha} \overline{a_\alpha a_\alpha} - \frac{1}{H_\beta} \overline{a_\beta a_\beta} = 0 \quad \{51\}$$

The quantities  $\overline{a_\alpha a_\alpha}$ ,  $\overline{a_\alpha a_\beta}$ ,  $\overline{a_\alpha a_R}$ ,  $\overline{a_\beta a_\alpha}$ ,  $\overline{a_\beta a_\beta}$  and  $\overline{a_\beta a_R}$  are:

$$\overline{a_\alpha a_\alpha} = (1 + e_{\alpha\alpha}) \sigma_{\tilde{\alpha}\tilde{\alpha}} + \left( \frac{1}{2} e_{\alpha\beta} - \omega_R \right) \sigma_{\tilde{\alpha}\tilde{\beta}} \quad \{52\}$$

$$\overline{a_\alpha a_\beta} = \left( \frac{1}{2} e_{\alpha\beta} + \omega_R \right) \sigma_{\tilde{\alpha}\tilde{\alpha}} + (1 + e_{\beta\beta}) \sigma_{\tilde{\alpha}\tilde{\beta}} \quad \{53\}$$

$$\overline{a_\alpha a_R} = \left( \frac{1}{2} e_{\alpha R} - \omega_\beta \right) \sigma_{\tilde{\alpha}\tilde{\alpha}} + \left( \frac{1}{2} e_{\beta R} + \omega_\alpha \right) \sigma_{\tilde{\alpha}\tilde{\beta}} \quad \{54\}$$

$$\overline{a_\beta a_\alpha} = (1 + e_{\alpha\alpha}) \sigma_{\tilde{\beta}\tilde{\alpha}} + \left( \frac{1}{2} e_{\alpha\beta} - \omega_R \right) \sigma_{\tilde{\beta}\tilde{\beta}} \quad \{55\}$$

$$\overline{a_\beta a_\beta} = \left( \frac{1}{2} e_{\alpha\beta} + \omega_R \right) \sigma_{\tilde{\beta}\tilde{\alpha}} + (1 + e_{\beta\beta}) \sigma_{\tilde{\beta}\tilde{\beta}} \quad \{56\}$$

$$\overline{a_\beta a_R} = \left( \frac{1}{2} e_{\alpha R} - \omega_\beta \right) \sigma_{\tilde{\beta}\tilde{\alpha}} + \left( \frac{1}{2} e_{\beta R} + \omega_\alpha \right) \sigma_{\tilde{\beta}\tilde{\beta}} \quad \{57\}$$

The stresses are:

$$\sigma_{\tilde{\alpha}\tilde{\alpha}} = \frac{E}{1 - \mu^2} (\varepsilon_{\tilde{\alpha}\tilde{\alpha}} + \mu \varepsilon_{\tilde{\beta}\tilde{\beta}}) \quad \{58\}$$

$$\sigma_{\tilde{\beta}\tilde{\beta}} = \frac{E}{1 - \mu^2} (\varepsilon_{\tilde{\beta}\tilde{\beta}} + \mu \varepsilon_{\tilde{\alpha}\tilde{\alpha}}) \quad \{59\}$$

$$\sigma_{\tilde{\alpha}\tilde{\beta}} = \frac{E}{2(1 + \mu)} (\varepsilon_{\tilde{\alpha}\tilde{\beta}}) \quad \{60\}$$

And  $\sigma_{ij} = \sigma_{ji}$ .

### **The Normal Entry Condition**

The angle between of the particle paths and the  $\alpha$  coordinate is calculated in the same way as {32}, but the curvilinear coordinate values are used.

$$\tan(\psi) = \frac{\frac{1}{2} e_{\alpha\beta} + \omega_R}{1 + e_{\alpha\alpha}} \quad \{61\}$$

Let

$$e_{\alpha\beta bndry} = 2 \tan(\psi)(1 + e_{\alpha\alpha}) - 2\omega_R \quad \{62\}$$

Then, the normal entry boundary condition becomes,

$$\begin{aligned} \varepsilon_{\bar{\alpha}\bar{\beta}bndry} = & e_{\alpha\beta} + e_{\alpha\alpha} \left( \frac{1}{2} e_{\alpha\beta bndry} - \omega_R \right) + e_{\beta\beta} \left( \frac{1}{2} e_{\alpha\beta bndry} + \omega_R \right) \\ & + \left( \frac{1}{2} e_{\alpha R} - \omega_\beta \right) \left( \frac{1}{2} e_{\beta R} + \omega_\alpha \right) \end{aligned} \quad \{63\}$$

All the rollers in this case are assumed to be aligned, and the relaxed web isn't bent laterally. So,  $\psi = 0$ .

### **Summary of Boundary Conditions**

At the downstream roller, expressions {35} and {63} are used in {58} through {60} to create load-type boundary conditions for  $u$  and  $v$ . The value of  $w$  is set by the expression for  $w_{flat}$ , described in equation {65} below.

At the upstream roller, the value of  $u$  is set to zero. A load-type boundary condition is used for  $v$ . It is set to zero so that the web is free in the  $y$ -direction. The value of  $w$  is set to  $w_{flat}$ .

The edges are free. So, the values of load-type boundary conditions are set to zero for all three variables.

Since load-type conditions for  $v$  are used at both ends and on the edges, something must be done to avoid rigid body motion in the  $y$ -direction. The web has axial symmetry in the stressed state, so it is possible to constrain it by setting the integral of  $v$  on the perimeter to zero (a feature of any good solver).

### **Nonlinear Behavior**

Nonlinear PDEs often behave badly in numerical analysis because they can have multiple solutions. In spite of this, the nonlinear equations of elasticity perform surprisingly well when applied to 2D problems like the misaligned roller. Apparently, the physics of the problem insure that there is a unique solution. The 2D +  $w$  equations, especially when combined with curvilinear coordinates, are not so fortunate. When the variable  $w$  is introduced, Pandora's Box is opened. This is especially true when the desired solution involves compressive stresses. It then becomes possible for the web to wrinkle and this can happen in many different ways, especially for a membrane with no bending stiffness. But, even when compressive stress isn't present, the nonlinearities may cause instability. So, strategies must be found to help the solver. Sometimes, it may be possible to get acceptable results just by using a mesh that is too coarse for wrinkles to form. But, for problems like the baggy web, this won't do. Physical intuition is the best guide.

### **Forcing the Stressed Web to be Flat**

One of the things we know in advance about the solution is that the MD tension is pulling the web towards flatness. A real web may not actually become flat. But, much can still be learned from a model that forces flatness. If there are compressive stresses in a flattened model, we know that wrinkles *could have formed*. In the model just described, there is a way to constrain the solution in this way.

The plane of the stressed web is defined by setting the value of the  $z$  coordinate to a constant. This definition won't involve explicit use of the  $z$  coordinate, so it won't upset the 2D +  $w$  model.

$$z_o = (R_\alpha + R_\beta \cos(\beta_{\max})) \cos(\alpha_{\max}) \quad \{64\}$$

The values  $\alpha_{\max}$  and  $\beta_{\max}$  are the maximum values of  $\alpha$  and  $\beta$ . This positions the plane so that it just touches the four corners of the web.

To convert this to a form that can be used in the curvilinear coordinate system, it is necessary to find the values of  $w$  (it will be called  $w_{flat}$ ) that will bring every point of the relaxed web to the plane defined by {64}. The variable  $w$  is measured in the direction of  $R_\beta$ . So, applying a little trigonometry yields,

$$w_{flat} = \frac{1}{\cos(\beta)} \left[ \frac{z_o}{\cos(\alpha)} - (R_\alpha + R_\beta \cos(\beta)) \right] \quad \{65\}$$

Now, this is used in a term that is added to the right hand side of the  $z$ -direction equilibrium equation {51} to force the variable  $w$  toward  $w_{flat}$ . It is,

$$(w - w_{flat})10^6 \quad \{66\}$$

The  $10^6$  factor is an arbitrary, large value that is established by trial and error. Numerical analysts might call this a penalty function and argue that the difference between  $w$  and  $w_{flat}$  must become very small in order to simultaneously satisfy the left hand side of the equation. A better way of thinking about it is to imagine the factor  $10^6$  as being a uniformly distributed pressure that is forcing the web against a rigid, frictionless surface.

## Results

This is a very new model and there is no experimental data with which to test it. So, the following results should be viewed as tentative. The web parameters are:

Span length (chord) = 40 inches (1.016 m)  
 Width (chord) = 20 inches (0.508 m)  
 Thickness = 0.001 inch (0.025 mm)  
 Poisson ratio = 0.3  
 E = 500,000 psi (3.447 Gigapascals)  
 MD tension = 1000 psi (6.895 Megapascals)  
 Poloidal angle =  $\pm 2$  deg (0.035 radian)  
 Toroidal angle =  $\pm 2$  deg (0.035 radian)

Elliptic curvature:

$R_\alpha = 572.7$  inches (14.55 m)  
 $R_\beta = 286.54$  inches (7.28 m)  
 Difference in MD arc length at center compared to edge = + 0.02%

Hyperbolic curvature:

$R_\alpha = 572.7$  inches (14.55 m)

$R_\beta = -286.54$  inches (7.28 m)  
 Difference in MD arc length at center compared to edge = - 0.06

Results for elliptic baggy webs (edges shorter than center)

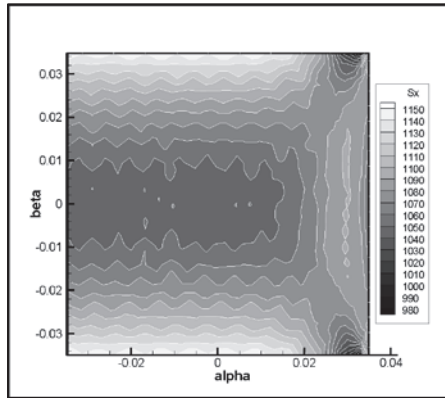

Figure 6 – MD stress, elliptic web  
 Axes in radians, stress in psi

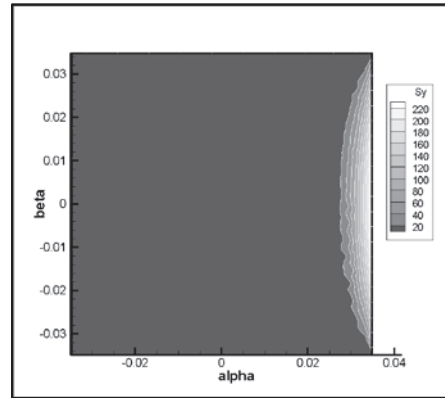

Figure 7 – CD stress, elliptic web  
 Axes in radians, stress in psi

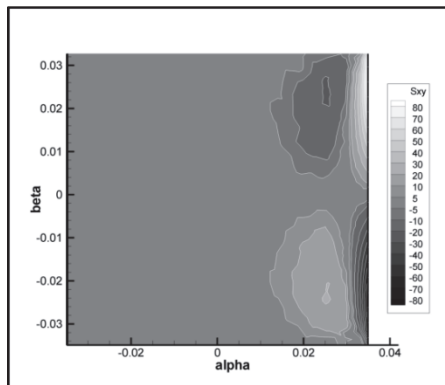

Figure 8 – Shear stress, elliptic web  
 Axes in radians, stress in psi

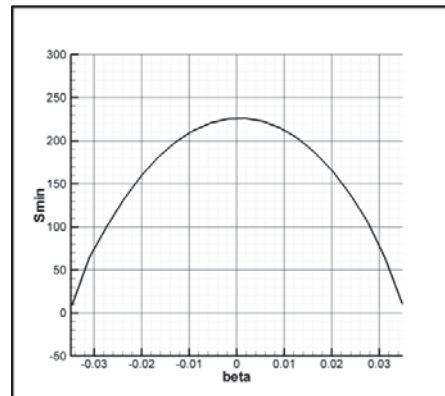

Figure 9 – Principal minimum stress  
 at downstream roller in psi

The elliptically curved web shows positive lateral stress at the downstream roller. So, it is self-spreading and behaving as though it is on a concave roller. This makes sense, because a concave spreader roller causes the MD stress to be higher at the edges than at the center. Note also that there is the same kind of shear profile as in a concave roller. The waviness in the contours of Figure 6 is due to the FEA mesh.

Results for hyperbolic web (edges longer than center)

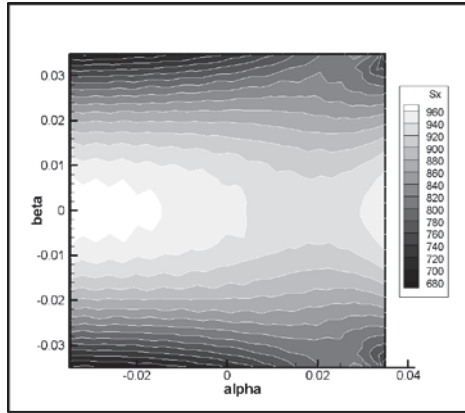

Figure 10 – MD stress  
Axes in radians, stress in psi

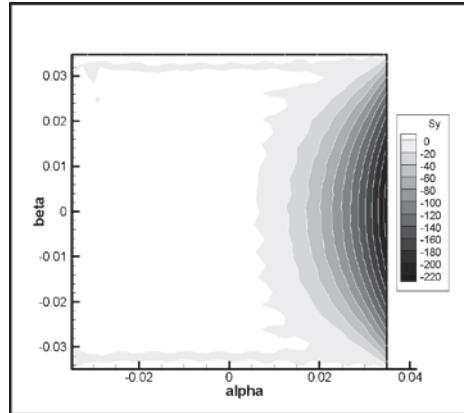

Figure 11 – CD stress  
Axes in radians, stress in psi

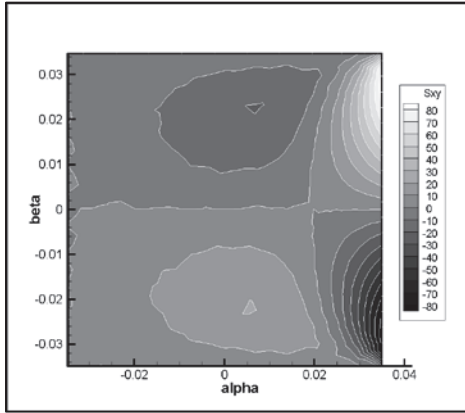

Figure 12 – Shear stress  
Axes in radians, stress in psi

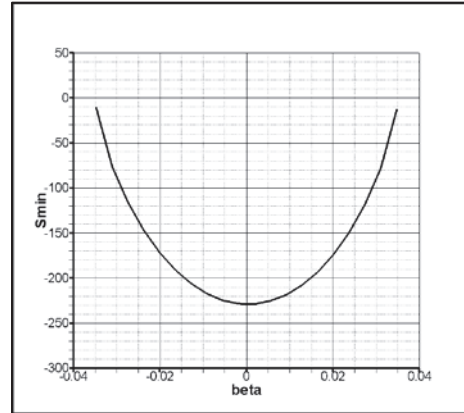

Figure 13 – Principal minimum stress  
at downstream roller in psi

The behavior of the hyperbolic web is the inverse of the elliptic web. Tension at the edges is lower than the center and it shows negative lateral stress at the downstream roller. It will tend to wrinkle as though it were on a convex roller.

### Model Consistency Tests

A convenient test of the model is to run it as though the web is being pulled over a frictionless mandrel shaped like the relaxed web. Under these conditions, the intuitive expectation is that the web should show very little variation in the  $\alpha$ -direction stress with perhaps a small amount of  $\beta$ -direction stress to account for the interaction of  $\alpha$ -direction stress with the lateral curvature. This is done by eliminating  $w$  as a variable and deleting the  $z$ -direction equilibrium equation. Then,  $\sigma_{\bar{\alpha}\bar{\alpha}}$  is set to 1000 psi in a load boundary condition at the downstream end. The web is fixed in the  $\alpha$ -direction at the upstream end and is left free in the  $\beta$ -direction at both ends. The edges are left free. To eliminate rigid body motion, the integral of  $v$  on the perimeter is set to zero. Intuitively, one would

expect that under these conditions, the web would show almost no variation in MD stress and there should be a small amount of CD stress due to the cross-web curvature. That is what happens. The variation in MD stress over the entire web is less than 0.1 psi from the 1000 psi load and the CD stress varies from a maximum of +0.22 psi at the centerline to 0 at the edges.

Another test is to move the  $w_{flat}$  plane to a different value of  $z_o$ . If the model is working correctly, the results shouldn't change. In the elliptic model, it was moved from the concave side, where it was touching the corners, to a position where it was tangent to the convex surface. There was no change in the results.

## CONCLUSIONS

The following are tentative conclusions, based on looking at a few examples of elliptic and hyperbolic models.

1. An elliptic (short on the edges) baggy web will not wrinkle at a downstream roller. It will develop lateral tensile stress like a uniform web on a concave roller. If the bagginess is observable, it is possible that the lateral tensile stress will be large enough to cause slipping and scratching.
2. A hyperbolic (long on the edges) baggy web may wrinkle at a downstream roller. It will develop lateral compressive stress like a uniform web on a crowned roller. If the bagginess is large enough to be observable, it is likely that the compressive stress will be so high that it will be difficult to prevent wrinkling.
3. The behavior of elliptic and hyperbolic webs will not change with the direction of wrap.
4. Increasing tension to pull out the slack may eliminate gross problems, but it won't change the tendency to spread or wrinkle.
5. A web that has narrow baggy lanes due to deep corrugations in a wound roll will likely have spreading where the peaks were and wrinkling at the valleys.

## REFERENCES

1. Brown, J. L., "A New Method for Analyzing the Deformation and Lateral Translation of a Moving Web." Proceedings of the Eighth International Conference on Web Handling, Oklahoma State University, 2005, pp. 39-59.
2. Reynolds, Osborne, "On the Efficiency of Belts or Straps as Communicators of Work", The Engineer, 38, 396, 1874 also in Papers on Mechanical and Physical Subjects, Vol. 1, Cambridge at the University Press, 1900, pp. 107-109.
3. Swift, H. W., "Power Transmission by Belts: An Investigation of Fundamentals," Institute of Mechanical Engineers, Vol. 115 (2), 1928, pp. 659-743.
4. Shelton, J. J., "Dynamics of Web Tension Control with Velocity and Torque Control," Proceedings of the American Control Conference, Atlanta, June 1988, pp. 1/5-5/5
5. Novozhilov, V. V., Foundations of the Nonlinear Theory of Elasticity, Graylock Press, 1953.
6. Timoshenko, S., Theory of Elastic Stability, ed 1, McGraw Hill, 1936, pp. 302-323.
7. Kreyszig, Erwin, Differential Geometry, Dover Publications, 1999, pp. 135-136.
8. Novozhilov, V. V., Thin Shell Theory, P. Noordhoff, Ltd., 1964, pp.105-112.

*The Use of Conservation of Mass in Modeling Lateral Behavior in Moving Webs*      **J. Brown**, Essex Systems, USA

**Name & Affiliation**

John Shelton, Oklahoma State University

**Question**

This is a marvelous paper. How often in our meetings have we heard of direction cosines, or nonlinear elasticity, or curvilinear coordinates, or vector algebra? There are other terms that I could comment on. The end comment about the shapes of webs that are likely to cause wrinkling, we've fumbled around with for a long time. I've been fumbling around with cambered webs for over 40 years. We don't always accomplish what we need to accomplish. This is not the solution to all the problems we have, but trying to change the properties of a web toward baggy edges (not to baggy edges) that are from other properties may be a way to go. This paper may point the way to this. I would like to congratulate you, Jerry, for the effort you put into this paper.

**Name & Affiliation**

Jerry Brown, Essex Systems

**Answer**

Thank you very much. That means a lot. Especially coming from you, John.

**Name & Affiliation**

Dilwyn Jones, Emral Ltd.

**Question**

I have a question about the plots of the stress, Figures 6-8. A lot is happening very close to the downstream roller. I'm struggling to understand how that's happening. As I see it, the downstream roller just picks up the web in the state it's in and transports it further. To me, things should be happening over the whole of that span and not just at the edge at the very end – the last 10% of that span. Have you any comment on that?

**Name & Affiliation**

Jerry Brown, Essex Systems

**Answer**

Do you mean the MD stress?

**Name & Affiliation**

Dilwyn Jones, Emral Ltd.

**Question**

The constant shear stresses in particular. You have these strange peaks at about 90% of the way towards the downstream roller.

**Name & Affiliation**

Jerry Brown, Essex Systems

**Answer**

That surprised me too. I think that is where the normal entry rule is taking charge of things. If you look at the other plots where I left the edges free, you'll see these resemble those very much except at the downstream end where the normal entry rule was taking over. The model didn't take into account normal entry effects at the entry to the upstream roller. I left that boundary free in the y-direction. As you have recognized, that isn't realistic, because whatever is happening at the entry to the downstream roller must also be happening at the entry upstream. At the time the abstract was submitted, I had no idea that I could produce a working model and even when the inspiration hit



during the writing, I debated with myself about whether there was time to do it without missing the deadline. So, I intentionally left that bit undone. All of my earlier work has indicated that the upstream stress profile has little effect downstream. So, I don't think any of the conclusions are adversely affected. I'll be adding that feature soon, though, and will let you know how it turns out. There is a small amount of stress variation, due to the flattening that isn't visible because of the spacing of the contours in the plot.