

ULTRASONIC BASED MULTIPLE WEB SENSING FOR LATERAL CONTROL APPLICATION

By

**Jami Haque, Darcy Winter, and William Ploetz
Fife Corporation
USA**

ABSTRACT

As sensing requirements in guiding applications increase in complexity, innovation must increase to meet these needs. In applications with multiple webs, space restrictions often limit the placement of sensors. In this case, a single sensor that can sense multiple edges would be desired. Sensing multiple edges within the same sensor opens other new possibilities in guiding applications as well.

To address these needs, staggered arrays of ultrasonic transducers in a through-beam configuration can be employed using a combination of FPGA and microprocessor based technology. The transmit side consists of an array of ultrasonic transducers which are driven individually with a precisely timed signal. The receiver side consists of an identically arranged array of transducers diametrically opposed to the transmitter. To handle the concept of multiple edges, a methodology can be adopted to partition the sensor field of view into many individual "virtual sensors". Virtual sensors can further be selective about the type of edge polarity they sense. Because virtual sensors exist only mathematically, they can overlap each other in any conceivable manner and can be moved around to reposition their respective webs. This scheme has another advantage that is useful particularly in sensing and guiding applications. The entire sensor field of view is active at all times which opens the possibility to provide multiple edge tracking within the complete sensor field of view.

Ultrasonic sensing technology is often preferred for its ability to sense wide varieties of materials such as opaque, clear and photosensitive type web materials. However it is often limited to smaller bandwidth because of transducer size. Those sensors that offer wider sensor field of view are typically limited to single edge detection. Multiple edge detection with edge polarity awareness is achieved by keeping all of the transducers active at all times. A sensor with these capabilities can operate like a conventional sensor with a single edge, or provide more advanced capability using multiple edge detection. Multi-edge applications include center or edge guiding one or more webs, multiple web width measurement, web position, and lane measurement (distance between webs).

NOMENCLATURE

RTOS	Real time operation system
PLL	Phase lock loop
FPGA	Field programmable gate array
CPLD	Complex programmable logic device
PTP	Precision time protocol

INTRODUCTION

A large bandwidth sensor can be realized through multiplicity of smaller transducers[1]. This method has an advantage when it comes to signal sensitivity but is further complicated by the task of driving and receiving such multiple signals. A common issue with ultrasonic sensing technology is reflected energy, which can lead to the presence of standing waves in the sensing gap. This can result in the presence of misleading signals at the receiver due to sound pressure levels arriving in and out of phase with the desired signal. Ultrasonic sensing is also medium-dependent which must also be considered when working with this technology. In most web applications, air is the expected medium, with temperature being the most influential variable. One might initially believe that pinging all of the transmitters simultaneously would be desired, but upon further analysis, this has two drawbacks:

1. A large amount of current (proportional to the number of transmitters) would be required at the moment of transmission.
2. The geometry of the sensor placement, combined with the transmission beam angle would cause the aforementioned sound pressure level phase variations to affect neighboring receivers due to the slightly longer signal travel path. If the medium changes, so does the signal propagation time, which then introduces dynamic sound pressure level phase conflicts.

An approach that combats this problem can be realized by a preconceived ping firing order where only one transmitter is active at any given time thus solving the current requirement problem. This “multiplexing” of the ping order can be further designed to prevent adjacent transducer pairs from being active at or near the same time. This has the desired effect of isolating the receivers so they can identify the intended signal without interference from nearby transducer pairs. The signal dispersion caused by the transmitter’s beam transmission profile is unavoidable, but the effects of stray signals at adjacent channels can be managed by synchronizing each receiver with the expected signal arrival time.

This scheme has another advantage that is useful particularly in sensing and guiding applications. The entire sensor field of view is active at all times which opens the possibility to provide multiple edge tracking within the complete field of view.

SENSOR CONSTRUCTION AND DESCRIPTION

The sensor is constructed by staggering multiple smaller ultrasonic transducers in a through-beam configuration where transmit and receive transducers are facing each other.

Hardware

The sensor system block diagram consists of three main blocks such as Master, Transmitter and Receiver block as shown in Figure 1.

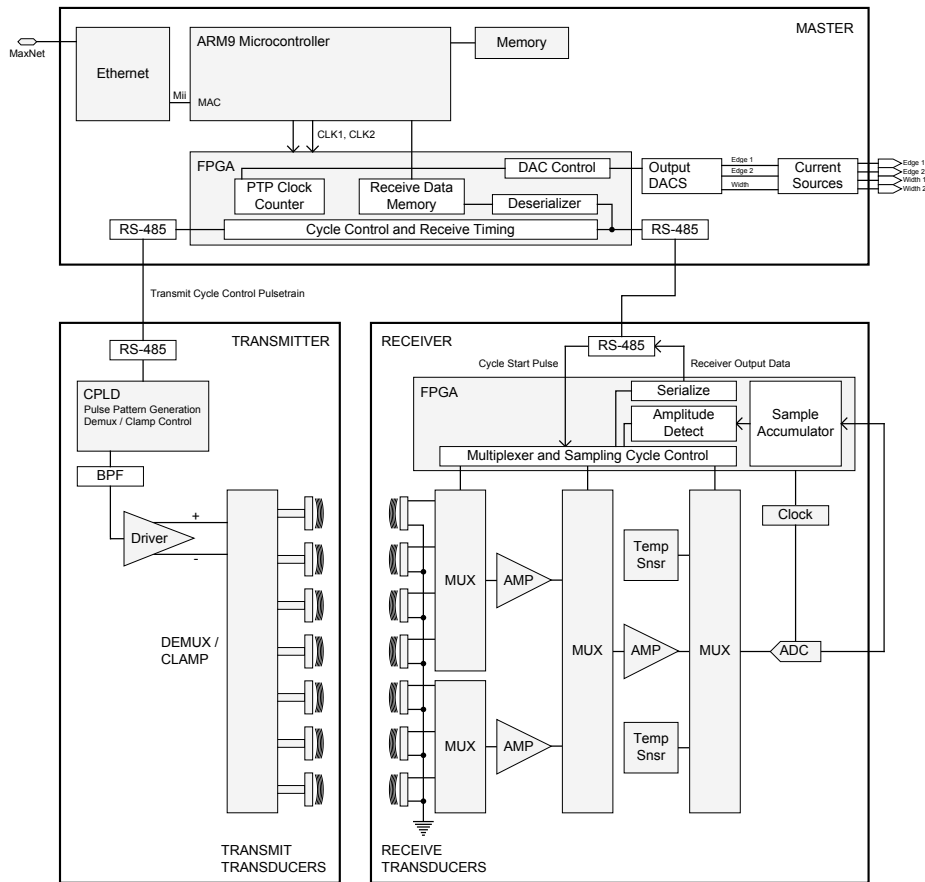

Figure 1 – Sensor system block diagram

A brief description of each block and associated operations are as follows-

Master: The master block consists of a microprocessor, FPGA, and associated support logic. A clock based on the processor's PLL-generated clock is provided to the FPGA for the basis of all its internal timing. The FPGA provides nanosecond clock control for PTP synchronization and initiates transmit and receive scan cycles via communication to the transmitter block CPLD and receiver block FPGA. The main processor additionally controls analog output signals to represent edge position and web width and can also output such data via Ethernet.

Transmitter: The transmitter block is made up of a CPLD, bandpass filters, push-pull drive amplifiers, multiplexers, and an array of ultrasonic transducers. Upon reception of a cycle start command which is initiated at regular intervals from the main processor FPGA, the transmit CPLD begins an uninterruptible cycle where it generates ping bursts of a small number of periods at the transducer resonant frequency which are gated to the appropriate transmitter. These bursts are each directed to a single transducer in a predetermined sequence to maximize the time between activation of adjacent transducers. This helps to reduce effects of adjacent channel interference.

Receiver: The receiver block is made up of an FPGA, analog to digital converter, amplifiers, multiplexers, and an array of ultrasonic transducers. To avoid collection of unwanted signals, the receive transducers are only monitored within specific time windows which are determined mainly by the distance between transmit and receive transducers. Ultrasonic energy transmission is also subject to medium changes, which can influence the signal arrival time. Of the many factors that affect the medium, temperature has the most detrimental effect. To combat this, the main processor collects temperature information from two sensors contained in the receiver block. Using this information, it alters the receive cycle start time via a register in the FPGA which effectively synchronizes the receive cycle to the expected signal arrival time relative to the current temperature.

Software architecture and implementation

In order to successfully implement a sensor with the processing capabilities described here implies a need for adequate processor capability. There are many embedded processors available that can handle this workload. An RTOS can also be very useful to split the task into multiple parts. A good example for multiple thread approach would be in the layered approach outlined above. Each software layer can be implemented as a separate thread using inter-thread synchronization to trigger execution of each successive layer of processing. The initial starting layer is typically triggered by an interrupt from hardware when new data has arrived.

The processing of multiple edges presents many challenges, but as described here can be managed by a layered approach (Table 1) similar to how a communication stack works. Here is a brief outline of the layers involved.

Layer 7 Software	Signal Outputs
Layer 6 Software	Virtual Sensor Handling
Layer 5 Software	Linearization
Layer 4 Software	Fine Edge Position Determination
Layer 3 Software	Coarse Edge Location and Type Identification
Layer 2 Software	Signal Conditioning
Layer 1 Physical Layer	Physical Layer Opposing transducer arrays with supporting hardware capable of driving the transmitters and amplifying received ultrasonic signals. To support multiple edge capability, this hardware must process all transducers on every cycle. Provide temperature feedback and means to adjust the expected signal arrival time

Table 1 – Sensor implementation architecture

Signal conditioning (Layer 2): To Collect all transducer signals from hardware and provide temperature compensation, signal conditioning and normalization. Upon completion of a receive cycle, just after the last temperature value is received, an interrupt is generated to the processor. The arrival of this interrupt starts the software processing cycle which then collects all receive signals from the FPGA registers because these

registers will be overwritten during the next cycle. The signals go through several conditioning stages before being used to located edges.

The first step applies temperature compensation by multiplying each transducer value with a stored gain factor. There are two possibilities for this compensation. Normally, the gain curve is a single curve used for all transducers. This curve was derived using many temperature test runs of different transducers to create a best fit for all. In an optional version of the sensor, a calibration is performed where the sensor is exposed to a temperature gradient from 0°C to 60°C. During this time, the sensor builds a custom compensation curve unique for each individual transducer. In either case, the relevant compensation value is used to adjust the raw transducer value. An example of the transducer performance profile is shown below. In this test, the transducer pair is exposed to the temperature range over an extended period of time while monitoring the transducer receive signal.

The following plots illustrate steps involved to obtain a temperature compensated signal. First the raw signal is shown in Figure 2.

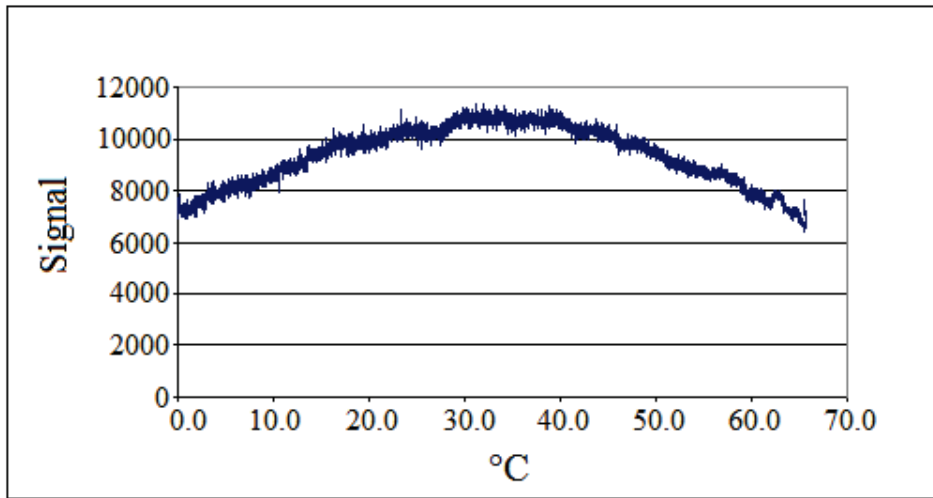

Figure 2 – Single raw transducer temperature characteristics

With some filtering applied followed by curve fitting (Figure 3).

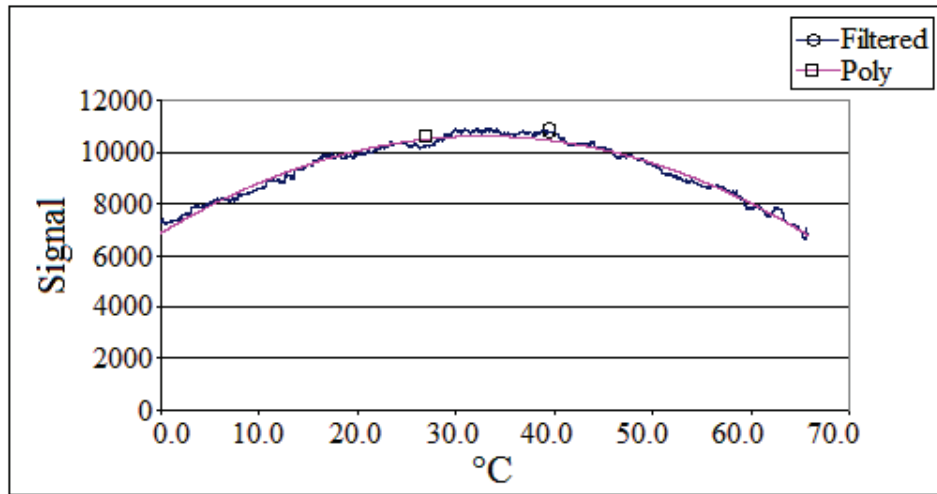

Figure 3 – Filtered signal with polynomial estimation

Compensation factor (Figure 4) computed for each temperature.

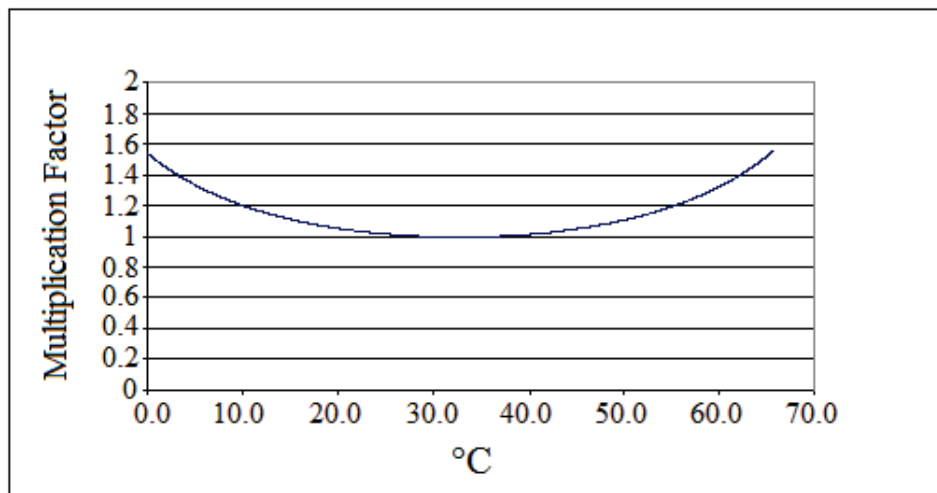

Figure 4 – Temperature compensation factor

Compensation factor applied to original signal (Figure 5).

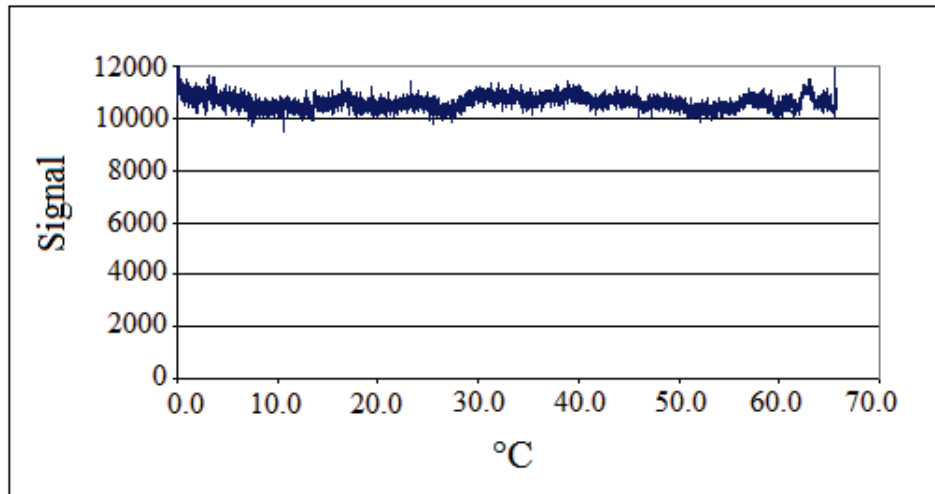

Figure 5 – Temperature compensated signal

The next step is normalization. As seen in the plots, each transducer value is multiplied by a gain factor collected from a table based on the current temperature. This has the effect of providing a more uniform response over the supported temperature range. The individual transducer values at this point are still unsuitable for direct use because even with this compensation applied, the maximum and minimum values are still different for each one. The next step is to normalize the signal so they are all uniform in scale. In this case, the desired scale is 0 to 16383. An example of the raw transducer signals is shown below (Figure 6).

Typical raw transducer signal levels (101 transducers)

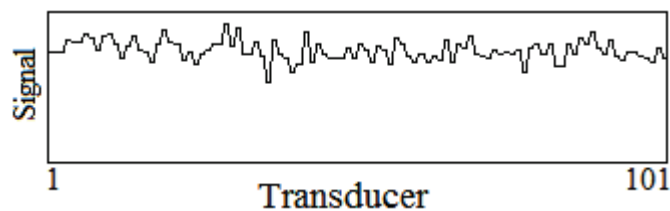

Figure 6 – Typical raw signal level from all transducers

Normalization is accomplished in a calibration step where each transducer is evaluated in its fully covered and fully uncovered state. This is typically an automated process. The maximum and minimum values are collected during this process and used to produce a gain factor. The gain and the minimum value are then stored in non-volatile memory and used during operation to normalize each transducer individually after each scan. The normalization gain is calculated as follows:

$$Gain_{Norm} = \frac{16383}{\max - \min} \quad \{1\}$$

Using the stored normalization data, the temperature compensated transducer values are normalized according to the formula shown below. Each transducer signal at this point produces a signal value of 0 when covered, and a value of 16383 when uncovered.

$$Signal_{Adj} = (Signal - min) \times Gain_{Norm} \quad \{2\}$$

Figure 7 shows transducer signal levels after normalization (101 transducers)

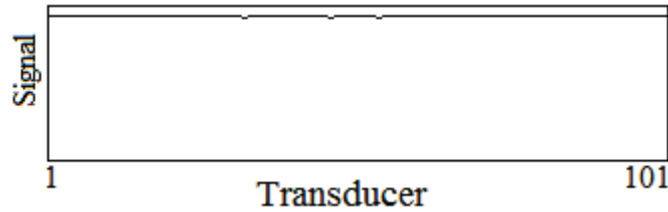

Figure 7 – Normalized transducer signal level

Normalized signal levels with a single web in place (Figure 8)

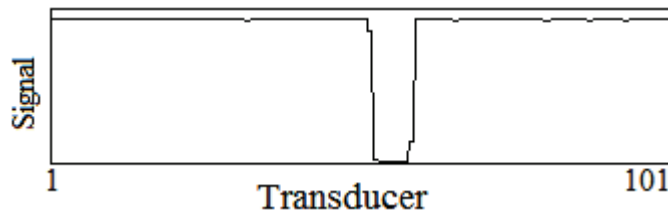

Figure 8 – Normalized signal levels with one web in place

with the scanning hardware active on all transducers every cycle, multiple web sensing becomes feasible. The graph below represents the normalized transducer profile with two webs in the field of view. Many webs can be sensed up to the limitation of available processing capacity.

Figure 9 shows normalized signal levels with 2 webs in place

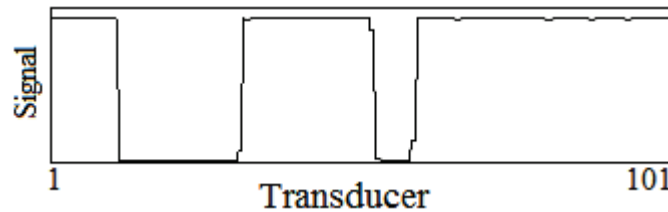

Figure 9 – Normalized signal levels with 2 webs in place

Coarse Edge Location and Type Identification(Layer 3): To examine normalized transducer data to identify which transducers contain edge transitions and determine their associated edge polarity. Because all transducer values are updated on each cycle, multiple edge tracking is possible. The adjusted transducer values are scanned from the closed end of the sensor toward the open end. The scanning methodology is designed to identify which transducers should be interrogated more closely for actual edge position(s).

A useful side effect from the chosen algorithm also identifies the edge polarity for the transition, which can be of further use later in the edge processing logic. For the purpose of this discussion, web edge polarities shall be described relative to the scan direction. For instance an “on-web” transition is considered the change from an uncovered state to a covered state as shown below. The “off-web” change is the opposite state change (Figure 10).

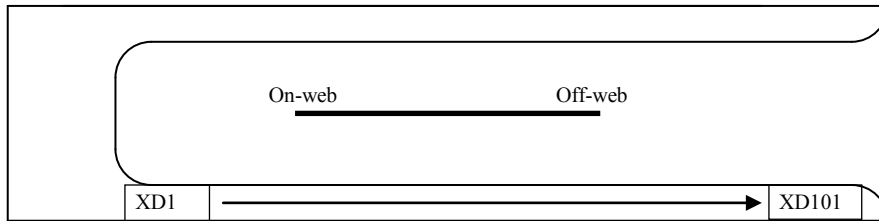

Figure 10 – Web edge polarity with respect to scan direction

The transducers of interest for edge location are identified by assigning an edge confidence factor using the following formula.

On-Web edge confidence factor calculation:

$$XD_{OnWebConf} = (XD_{n-1} - XD_n) + (XD_n - XD_{n+1}) \quad \{3\}$$

$$\text{If } XD_{OnWebConf} < 0 \text{ then } XD_{OnWebConf} = 0$$

Off-Web edge confidence factor calculation:

$$XD_{OffWebConf} = (XD_n - XD_{n-1}) + (XD_{n+1} - XD_n) \quad \{4\}$$

$$\text{if } XD_{OffWebConf} < 0 \text{ then } XD_{OffWebConf} = 0$$

Next, an array of potential “edge handles” (Figure 11) are built for all transducers, which have a confidence factor above an established threshold. An “edge handle” contains information about the edge polarity and identifies a primary and alternate transducer (if applicable) involved with each edge. A primary transducer is declared when its confidence factor is above a predetermined threshold, and is greater than the confidence factor of either of its adjacent transducers. The adjacent transducers of each primary edge are then tested for qualification as an alternate edge transducer. The adjacent transducer with the next highest confidence factor that is above an adjustable “blending factor” is then considered the alternate edge transducer. The result of this process produces a 16-bit “edge handle” identifying the primary transducer, alternate transducer, and the edge polarity (on-web or off-web).

Edge Handle Format															
15	14	13	12	11	10	9	8	7	6	5	4	3	2	1	0
Alternate Transducer(if not 0xFF)								Type 1=Onweb 0=Offweb	Primary Transducer						

Figure 11 – Web edge handle format

Each edge (Figure 12) detected has a corresponding edge handle in the edge array.

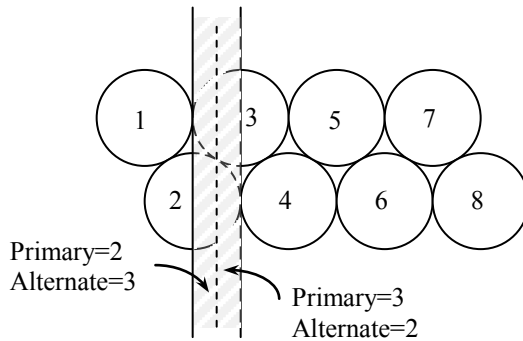

Figure 12 – Primary/alternate transducer area designation

After one or more edges have been identified and placed in the array of edge handles, their actual position relative to the entire sensor field of view must be determined. Before describing this process, some other related details must be presented.

Fine Edge Position Determination (Layer 4): To Process signals from transducers with edge transitions to determine absolute edge location(s) relative to entire sensor field of view. Since a sensor of this type is constructed using arrays of transducers, the field of view changes based on the number of transducers used in its construction. For signal generation purposes, it is desirable to have a common signal magnitude so some form of scaling must be employed to account for the various field of view sizes produced. The following formula produces the required scale based on the transducer count.

$$Scale = \frac{Output_{max}}{XDCount \times XD_{norm}} \quad \{5\}$$

A 16-bit value is a common compromise in signal handling to provide resolution versus processing bandwidth. Application of 16-bit handling to the above formula provides the following scaling assuming a 101 transducer sensor...

$$Scale = \frac{65535}{101 \times 16383} \quad \text{or...} \quad Scale = 0.03960577$$

As each transducer contributes roughly 5.1mm of bandwidth, this translates to

$$Fov_{mm} = 101 \times 5.1 \quad \text{or...} \quad 510.1mm$$

16-bit resolution applied to a 510mm field of view provides sensor resolution of 0.007mm/bit. Sensor configurations shorter than 101 transducers increase the resolution proportionally.

To determine the side effect of edge polarity, the next step involves converting the edge handle to a scaled number ranging from 0 to 65535 representing a relative position within the entire sensor bandwidth. As described before, this provides sensor resolution of about 0.007mm on a 510.1mm sensor. Multiple edge handling provides another obstacle to complicate this process. The conversion must be handled differently depending on the

polarity of the detected edge. This is required because of the difference between signal levels that occur naturally between the two edge polarities. Consider the effect on transducer number 7 in the two illustrations below. The edge of interest on transducer 7 is an “off-web” transition on the top example while it is an “on-web” transition on the bottom. It would be desirable for the edge position relative to the entire sensor field of view to be identically reported in both of these situations (because it is actually the same location relative to the FOV). Notice however that the signal produced on transducer 7 will be quite different for both of these conditions as on the top it is mostly uncovered, while on the bottom, it is mostly covered. Transducer 6 would likely be the alternate in this case and also suffers from the same condition. For this reason, the edge polarity must invoke one of two different conversion formulas when converting the primary and alternate transducer signals to an absolute position.

The following Figure 13 shows the handling the same location for each edge polarity

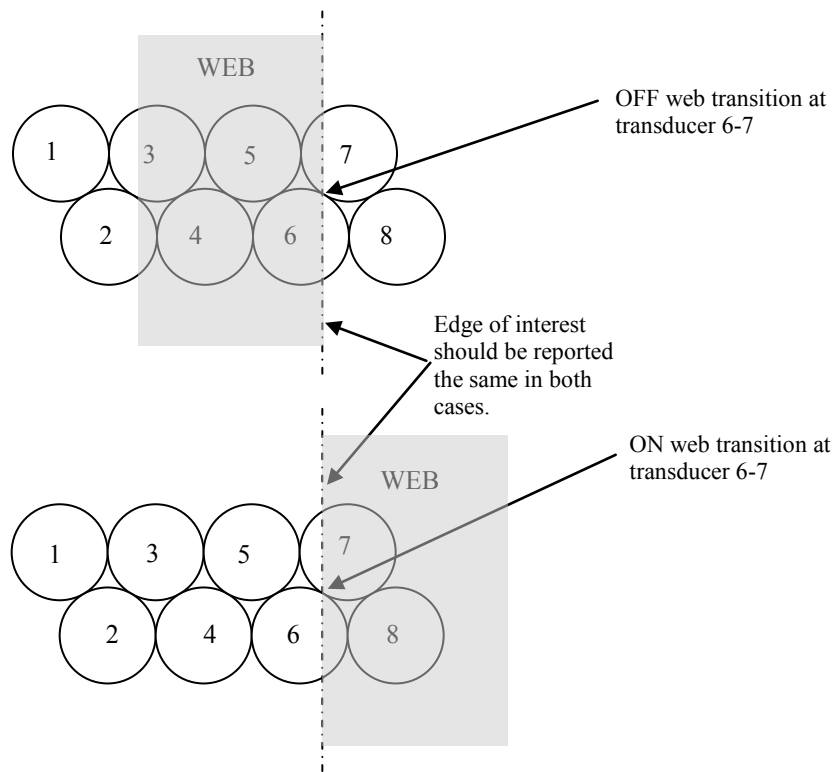

Figure 13 – Handling the same location for edge polarity

The explanation of the linearity process helps to highlight another signal handling aspect in the area of noise reduction. In the linearity example, the sensor output signal was created through the summation all the individual transducer signals. Since ultrasonic technology is inherently noisy, this has the disadvantage of adding the noise of every transducer into the final output signal. As more transducers are added to the array, the noise only increases. As described previously, the actual signal is generated using at most, only two transducers at any given time. By using the transducer position in the array as a

multiplier, a noise-free “offset” is applied before combining the actual transducer signals of interest.

Linearization (Layer 5): To translate the absolute edge location through linearization adjustment to produce a linear-adjusted absolute edge location for each edge in the field of view. The calculated position obtained above provides a signal that is adequate for guiding applications but with some additional signal processing the signal linearity can be improved. During an optional calibration procedure, a simulated web can be made to traverse the sensor field of view at a precisely controlled speed. The position information obtained during this process along with the knowledge that the speed of movement was constant can then be applied to generate a compensation profile capable of improving the output linearity. This process works by waiting for the calibration web to enter the sensor field of view. Arrival of the web starts recording the edge position information until the web traverses the complete field of view. A linear line can then be mathematically generated to project the desired performance between the beginning and end points. Each actual recorded value is then used to build a compensation offset required to track the desired profile. In practice, even though samples are collected at high speed, some points will be missing from the recorded data. To complete the compensation profile, the missing data are constructed by interpolating between adjacent samples.

Linearization helps to overcome the “personality” that exists when constructing a sensor of many transducers with each having a unique profile along with the complex behavior that exists in the overlapping areas between transducers. The on-web and off-web profiles are typically unique, so the calibration process builds and stores compensation for both edge polarities. When translating the calculated edge to the compensated edge, once again the polarity information becomes useful to access the correct compensation array.

The Figure 14 and 15 shows sensor linearity before and after compensation. For the purpose of showing the linearity concept, in the figures shown below, each transducer has been normalized and scaled to a range of 0 to 1000, and the combined output is simply the sum of all transducer signals.

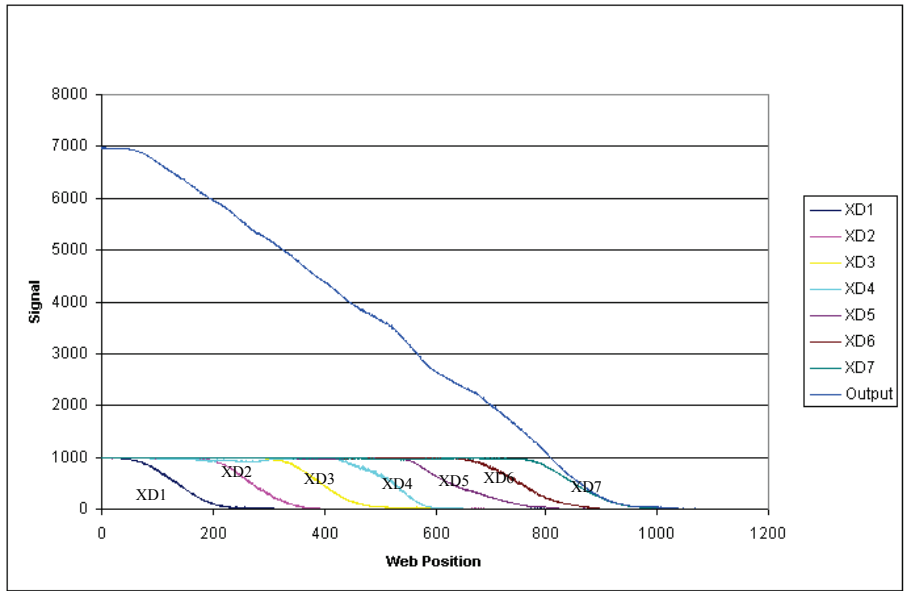

Figure 14 – Linearity plot without linear compensation

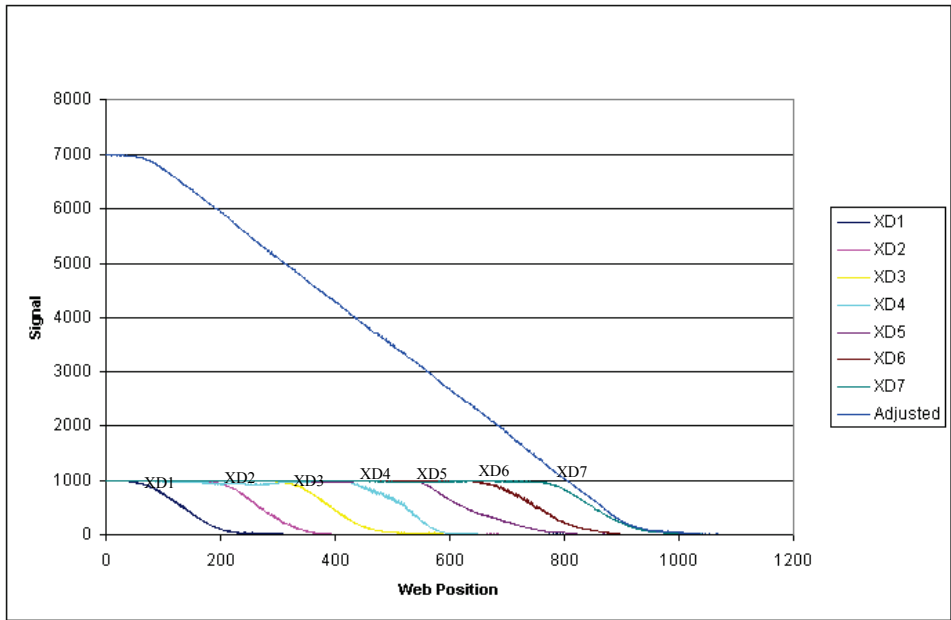

Figure 15 – Linearity plot with linear compensation

Virtual sensor handling (Layer 6): To update virtual sensor outputs using the absolute edge information for each qualified edge found in each virtual sensor. At this point, the edge processing logic has produced the polarity and relative position of all

edges in the sensor field of view. These signals are suitable for many types of guiding applications but with the addition of yet another layer of signal processing some additional capabilities can be realized. A virtual sensor is simply a configurable layer, which describes mathematical sensor boundaries that exist within the entire field of view. A virtual sensor can utilize the entire bandwidth of the sensor or a subset thereof. Boundaries are defined in the sensor field of view using the same resolution as the sensor signals so they can be positioned at the highest resolution of the sensor (not limited by the physical transducer boundaries). This opens the possibility to use virtual sensors to slowly reposition webs by slowly shifting them to the desired location. As these sensors exist only mathematically they can overlap in any conceivable manner to produce many varieties of output signals. Virtual sensors in their simplest form can provide center guiding using two overlapping opposing polarity virtual sensors (Figure 16):

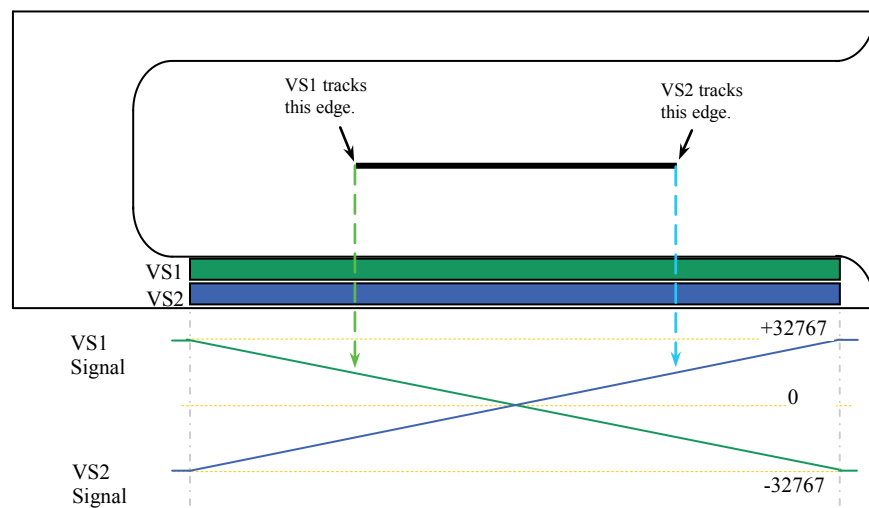

Figure 16 – Virtual sensors using one web

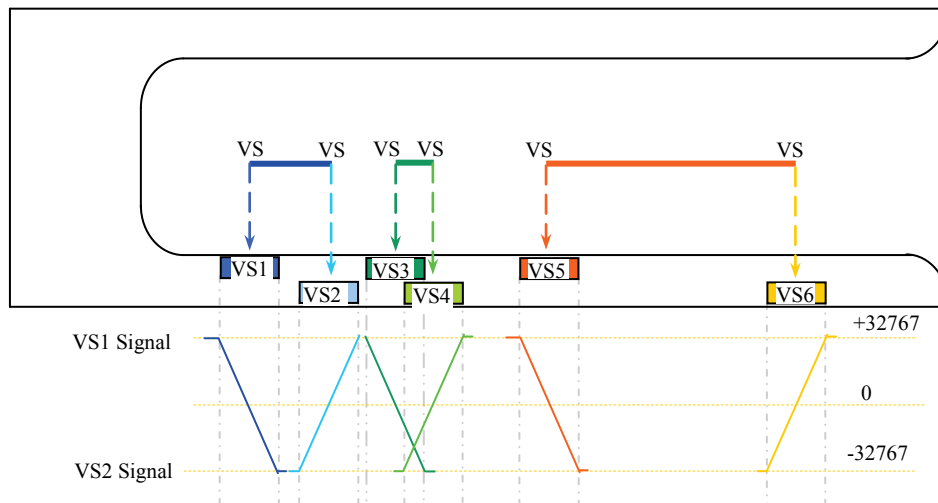

Figure 17 – Virtual sensors using multiple webs

(a) Advantages of edge polarity awareness

Another important property of the virtual sensor is edge polarity awareness. As shown in Figure 18, edge polarity awareness has advantages in crowded web conditions. A minimum spacing of at least one transducer width must be maintained to allow edge polarity detection to function.

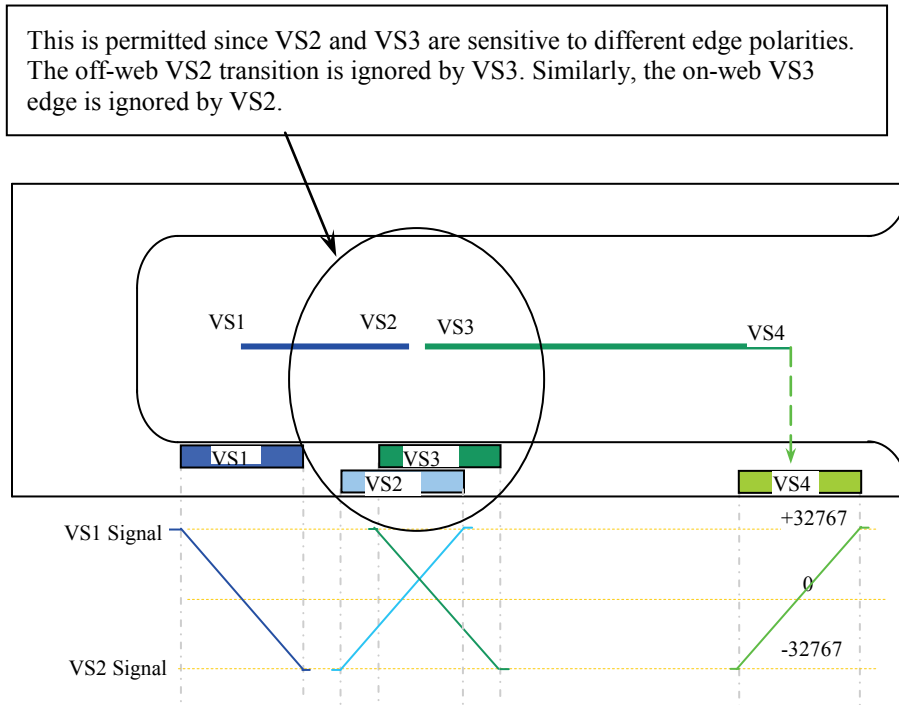

Figure 18 – Edge polarity awareness

Even though virtual sensor signals are generated based on the edge information present in their limited field of view, the processing logic can also “look outside” this field of view as needed to make decisions if a desired edge polarity is missing. For example if VS1 is expecting an on-web edge, but has only an off-web edge, it will maintain a “fully covered” signal intended to cause web correction that will bring the on-web edge (of this web) back into its field of view. The same is true of the opposite edge.

(b) Automated Edge Learning

Since the scanning process produces all the web edge locations and their respective polarities, it is but a simple matter to automate the processes of building virtual sensors on command. This is typically accomplished by placing one or more webs in the sensor at their desired locations and initiating the appropriate command. This process builds a virtual sensor at each edge and automatically assigns appropriate edge polarity. Furthermore, as the virtual sensors are simply a set of parameters that are fed to the virtual sensor layer, it is a natural step to organize this information in array form to allow multiple job configuration save/recall capability.

(c) User programmability

Virtual sensor handling in layer 6 provides the opportunity to insert some useful programmability into the system. Since the virtual sensors control the eventual final output signals, adding a method to command the parameters in this layer provides control of the sensor behavior without exposing the inner details of individual transducer and edge processing. Using fieldbus connectivity is the best way to implement such control.

(d) Sensor linking

Another concept made possible by virtual sensors is that of dynamic sensor linking. This technique supports logically “linking” one or more virtual sensors together so that commands to shift one virtual sensor causes all of them to move the same direction and speed. Sensor linking is implemented dynamically so it can be turned on and off controlled as needed.

Signal outputs (Layer 7): To scale and direct all uniquely configured signals to their destinations through software multiplexing. With the possibility to track many edges comes the dilemma of how to represent so many signals.

The Figure 19 and Table 2 below indicate what signals can be produced from the signal processing methods described thus far.

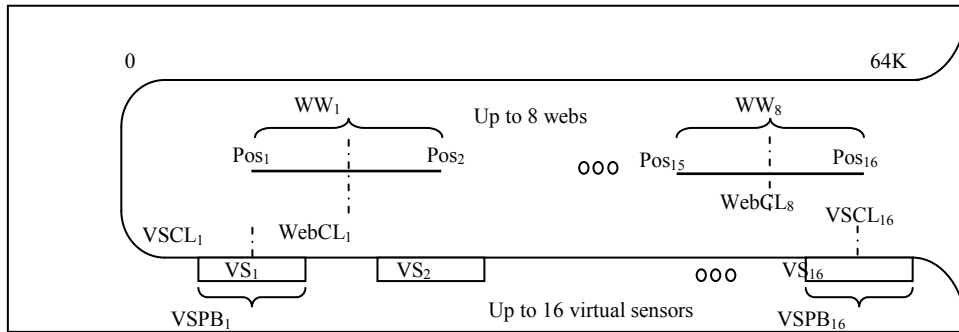

Figure 19 – Available sensor signals

Signals	
Signal	Description
Pos ₁ - Pos ₁₆	Absolute edge position within sensor complete field of view.(Note 1)
VS ₁ - VS ₁₆	Output from virtual sensor with respect to its programmed proportional band size, polarity, and edges detected within its field of view.
VSPB ₁ - SPB ₁₆	Virtual sensor proportional band.
VSCL ₁ - VSCL ₁₆	Virtual sensor absolute locations relative to the sensor complete field of view.
WW ₁ - WW ₈	Web width.
WebCL ₁ - WebCL ₈	Web center location relative to sensor field of view.

Table 2 – Available sensor signals description

Note1: Another signal that could easily be derived from two or more of these signals is the distance between webs (lane measurement).

(a) Signal formats

Decisions are also required concerning signal formats. In some cases a unit of measurement makes sense. For example web width in inches would be useful but the output of a virtual sensor in inches would not be very applicable.

(b) Signal Routing

So many signals and scaling possibilities make for some interesting configuration problems. To address the multitude of combinations, software can be organized in a way to allow signals to be routed and scaled according to user requirements. Often an analog output is needed but since this requires hardware support it, the number of output analog channels is often limited. A workable solution for this problem is to provide a software multiplexing scheme which directs configured signals to the desired analog output. In this method the end user decides which edges are needed in advance, and those edge signals are “mapped” or routed to the appropriate analog channel. Having mapping configuration unique for each job could also provide multiple job support.

This same technique can also be employed to handle signal scaling. A programmable scaling block can be inserted between a source and destination to scale a value on its way through. This allows the original signal delivered by the basic sensor processing logic to stay unchanged while derivatives of it can be generated as needed by configuration.

EXPERIMENTAL RESULTS

The experiments were conducted by using a sensor with a 20.28 inch proportional band. Using output collected in real time from this device over an Ethernet link, a PC-based application can graphically represent the information provided. The following images (Figure 20 through 25) represent screen captures from such an application. This information is provided in the following format:

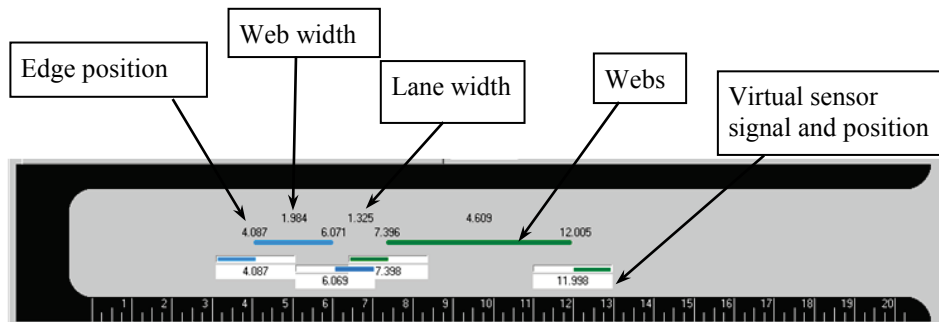

Figure 20 – Sensor Screen capture data identification

Some virtual sensor application examples using a sensor with a 20.28 inch proportional band:

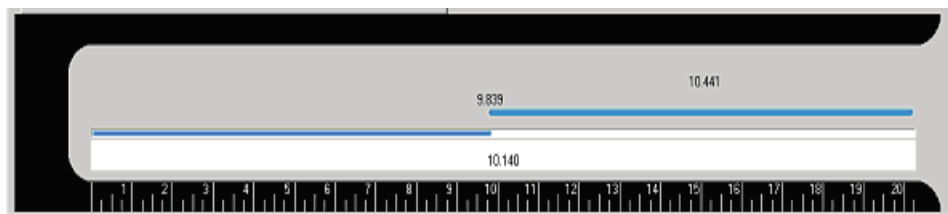

Figure 21 – Data for conventional single edge guiding



Figure 22 – Center-guiding a single web with two overlapping 20.28 inch virtual sensors

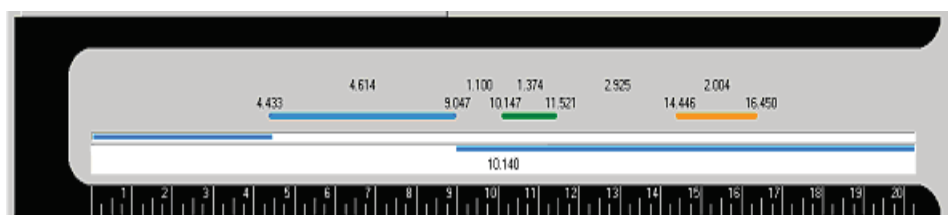

Figure 23 – Guiding on either edge of “first web”



Figure 24 – Two webs with overlapping 2 inch virtual sensors (edge polarity)



Figure 25 – 8 webs with 16 1.0 inch virtual sensors

CONCLUSION

Arrayed sensors typically perform some type of sequential scan in order to provide detection of a single edge. Once the edge is located, it can be tracked from one transducer to another and rescanning the array is only needed if the edge is lost. This method has been used successfully in many single-edge sensing applications. Depending on the requirements, the scanning algorithm could identify the first edge, the last edge, or if sophisticated enough, possibly a specific edge count but in the end only a single edge is involved. Scanning all transducers on every scan cycle provides several benefits that are not possible otherwise.

No specific rescan needed to find edges: Since all transducers are active every cycle, the entire array is effectively rescanned on every cycle, thus providing the most up to date information for all edges at the sensor cycle rate.

Edge polarity awareness: One might think edge polarity awareness is not significant, but it is this capability that makes overlapping virtual sensor techniques possible. Knowledge of edge polarity, allows a sensor to be selective about the edges that are present in its field of view so it may track one edge while ignoring another. This is essential for proper implementation of virtual sensors. Edge polarity can only be obtained with information from adjacent transducers near the actual edge position, which again requires all transducers to be scanned on each cycle.

Multiple concurrent edge sensing: Using this technique, a single sensor can guide or measure many webs. With the entire array active on each scan, the individual sensor update rates are all at the same speed. This permits:

- Guiding multiple webs with a single sensor
- One or more web widths with a single sensor
- One or more lane measurements with a single sensor

All of these features are made possible by scanning every transducer on every scan cycle.

ACKNOWLEDGEMENT

The authors would like to thank Ron Suenram, Product Manager, Fife Corporation for his assistance with the illustrations pertinent to this paper.

REFERENCES

1. Haque, M., Winter, D., Hueppelsheuser, D., Newton, J., and Storie, G., "Linear Edge Sensor," Proceedings of the Fifth International Conference on Web Handling, Oklahoma State University, June 1999, pp 491-507.

*Ultrasonic Based Multiple Web Sensing
for Lateral Control Application*

**J. Haque, D. Winter, & W.
Ploetz, Fife Corporation, USA**

Name & Affiliation

Ming Yang, Xerox
Corporation

Name & Affiliation

Jami Haque, Fife
Corporation

Name & Affiliation

Aravind Seshadri,
Oklahoma State University

Name & Affiliation

Jami Haque, Fife
Corporation

Name & Affiliation

Aravind Seshadri,
Oklahoma State University

Name & Affiliation

Jami Haque, Fife
Corporation

Name & Affiliation

Aravind Seshadri,
Oklahoma State University

Name & Affiliation

Jami Haque, Fife
Corporation

Name & Affiliation

Aravind Seshadri,
Oklahoma State University

Name & Affiliation

Jami Haque, Fife
Corporation

Name & Affiliation

Dan Perdue, Goss
International

Name & Affiliation

Jami Haque, Fife
Corporation

Question

What is the resolution? I see slippage on the order of
1/1000 of an inch?

Answer

The resolution is like .007 mm. It is a 16-bit resolution of a
20 inch proportional band (0.0003 in). Accuracy is a
different thing.

Question

What is your rate of output?

Answer

200 times per second or every 5 milliseconds.

Question

You said you had some 101 transducers. Each of those
transducers allow a proportional band, is that right?

Answer

Yes. This is correct.

Question

So you are basically looking at the amount of accumulation
based on each transducer?

Answer

Yes. We are monitoring each transducer all the time.

Question

What if there is some kind of discontinuity in the web, like
there is a hole or something like that?

Answer

We are updating the information in 5 milliseconds. So all
the information is available, all the transducers are active.
If you have a hole, you will know within 5 milliseconds.

Question

This may not be very good question. If you have two webs
and you are tracking both, and there is an upset in the
systems and the edges overlap momentarily, will that
confuse the sensor in any way?

Answer

Definitely, because it looks like one web.

DISCUSSION III

Leaders: N. Michal,
Kimberly-Clark Corp., and
R. Lynch, Procter & Gamble,
USA

Name & Affiliation

Neal Michal, Kimberly-
Clark Corporation

Question

We have had five papers this morning. Keith led with his talk on predicting wrinkles; Ron Swanson followed with lateral dynamics of a cambered web; Jan Erik Olsen with lateral displacements of nonuniform webs; Jerry Brown with 2D behavior of thin webs on rollers; Tim Walker on taxonomy of wrinkles; and Jami Haque with ultrasonic web sensing.

I'll start this off with a question for Keith – will we use the same expression to determine a buckling force for an actual roll of material? Say if you stack several rolls on top each other?

Name & Affiliation

Keith Good, Oklahoma
State University

Answer

I think you are saying would you use the Timoshenko shell buckling stress to look at the case of the roll, which is wound with multiple layers. If it is a layer that is deep in the roll, and it has pressure on both sides of it, then that is more like a beam supported by an elastic foundation; it has support on either side of it. The support that is on either side of it are other web layers whose stiffness is dictated by the radial modulus of the wound roll. If you are compressing all the layers at the same time and they all want to pop out of plane at the same time, that support will not help you. Probably Timoshenko's equation is pretty accurate at that point.

Name & Affiliation

Bob Lucas, Winder
Science

Question

I have been in press rooms where they have stored rolls 6-8 rolls end on end, and I have seen rolls that have failed with a diamond pattern failure at the bottom roll. It failed due to all the weight on top of the rolls on top of it. It failed all the way through the whole roll.

Name & Affiliation

Neal Michal, Kimberly-
Clark Corporation

Answer

I have the seen the same thing.

Name & Affiliation

Tim Walker, T. J. Walker
& Associates

Comment

John Shelton showed tin canning on wound roll data.

Name & Affiliation

Keith Good, Oklahoma
State University

Comment

That is correct. In that case, that is only the outer lap of the roll. You couldn't see the wavelength of what was beneath.

Name & Affiliation

Bob Lucas, Winder
Science

Comment

If you unwound it, you did.

Name & Affiliation
Keith Good, Oklahoma
State University

Answer
The data was taken on the outside of the roll. I was making the point the buckling may not have pervaded the entire wound roll.

Name & Affiliation
Ron Lynch, Procter &
Gamble

Question
A lot of our discussions this morning were on wrinkles. A lot of that has to do with friction. I can remember a while back trying to explain normal entry rules to a new hire engineer. You know, right angle to the axis of the roller. He promptly started correcting me on that. He had come out of the tire industry, so he used the example of tires on a roll. He then proceeded to explain to me that angle may be affected by the properties of the materials, the road surface, etc. Maybe there is already some work done in the tire industry on how webs steer just from the different point of view on what's rolling and what's not. There may be some similarity between the tire contact patch and the web in contact with a roller. Perhaps this might help us understand the web boundary conditions. I don't know if anyone here has worked in tire research, but there might be something there for web handling. Got any experiences or knowledge?

Name & Affiliation
John Shelton, Oklahoma
State University

Answer
I was working for a car company from 1957-1959 and I was quite interested in racing. Of course coefficient of friction is the ultimate problem to be solved with tires. I didn't foresee the impact of the width of tires that we would have on race cars. This stiffened them up – just a lower slip angle for a given force. Force is limited by friction. Back in the 1920s and 1930s, you saw cars crab around curves in road racing. Today you see this in NASCAR racing. The only way that the rear end can get a slip angle and develop its force is for the whole car to be at an angle.

Name & Affiliation
Ron Lynch, Procter &
Gamble

Comment
There is certainly continued interest in slipping and the contact path between the web and the rollers. I hope we see papers which focus on this at the next IWEB.

Name & Affiliation
Keith Good, Oklahoma
State University

Answer
The normal entry law has carried us a long way. There is a class of problems where there is some slip involved at the first point of contact or exit with a roller. Let's remember that we've been able to solve a large portion of our problems with the normal entry law.

Name & Affiliation
Ron Lynch, Procter &
Gamble

Comment
I don't disagree with that. That is certainly true. Perhaps we are moving from being able to make the Model T to being able to make the Model A. We need to learn a little more detail about the processes.

Name & Affiliation
Neal Michal, Kimberly-
Clark Corporation

Question
Ron Swanson: Is there any difference between a web that you cut out to look like a cambered web versus the genuine article?

Name & Affiliation

Ron Swanson, 3M
Company

Answer

I hope there is not a difference between a genuine cambered web and one that is cut out of a flat web. In fact, I think what we made was a true perfect cambered web. I think what we did is probably more accurate than what we had previously done by adding shims during winding and employing viscoelasticity to stretch the edge of the web. Cutting the camber definitely made a flatter web.

Name & Affiliation

Paul Weber, Kimberly-
Clark Corporation

Question

Ron, did you consider making a continuous sinusoidal cut versus a straight followed by a half sine? I noticed in that transition you had a lot of noise and I thought a continuous sinusoid might help reduce the noise.

Name & Affiliation

Ron Swanson, 3M
Company

Answer

I thought of that later after the experiment was run. A big sine wave really has a large transition to make into the straight section. A continuous sine probably would have been a good pattern to make. However what was important was that our cambered section was long enough for transient lateral behavior to die out and achieve steady state behavior. We adjusted the length of the cambered section to ensure steady state behavior was achieved. It was obvious from our output data that we achieved steady state.

Name & Affiliation

Keith Good, Oklahoma
State University

Comment

It was a dynamic experiment so it was nice to have the straight section so that we could ensure the web in the test span returned to zero deformation before the next half sine disturbance was introduced. It wasn't the nicest web to run through the machine because the transitions had to run through. There were times when we had to smooth wrinkles out when the straight to cambered web transition occurred.

Name & Affiliation

Dan Carlson, 3M Company

Answer

If you look at the webs you see that they have constant camber. If you run them out, all the webs I have seen have constant curvature, a sign of the angle of constant change. I would argue that the constant radius more closely matches the webs that we see.

Name & Affiliation

Paul Weber, Kimberly-
Clark Corporation

Comment

Because of that constantly changing radius, you would see that transition through as well.

Name & Affiliation

Dan Perdue, Goss
International

Comment

There's not a lot of time for the transient to stabilize into a nice steady state.

Name & Affiliation

John Shelton, Oklahoma
State University

Comment

In analysis, I don't know what to do other than look for a steady state condition which means a constant radius of curvature. Otherwise you have the curvature changing. Benson assumed the web shape was parabolic. A parabola is a very good approximation to a constant radius of curvature for many purposes. But a parabola can only withstand differentiation twice before it yields zero. The

third or fourth derivatives are zero, so there is really nothing to analyze if you assume the web is shaped like a parabola. I am arguing, as other people have, that the arc of a circle is the shape of a cambered web – a constant camber, a constant radius of curvature.

Name & Affiliation

Steve Lange, Procter & Gamble

Answer

I have handled webs that are traverse wound, or some people call a scatter wind, approach. There is yielding in the web because of the traversing at the end. If you cut that web out at the edges and lay it flat, it's a semi-circle and it does track to the wrong side of the web. Just when it's on one side of the roll, it tracks to that side and when it moves to the other side of the roll, it tracks to the other. It is not something I like – like Ron made it that way – I could prove that it didn't come to me that way. Generally, tensioning it highly helps with the tracking of that. I haven't quantified it, but I do believe friction is an effect that Ron saw. It is something I'll be trying to quantify myself.

Name & Affiliation

Neal Michal, Kimberly-Clark Corporation

Question

I have a question for my customer, Paul Weber. We make materials and then we ship them to Paul. Do you want webs that actually camber both directions?

Name & Affiliation

Paul Weber, Kimberly-Clark Corporation

Answer

No, you already give me that in the traverse winds. I think the random camber that you give me is good enough.

Name & Affiliation

Tim Walker, T. J. Walker & Associates

Question

Ron & Keith – one of the issues with the cambered web is its wrinkle sensitivity. You can imagine that if you try to bend it a certain direction, it's more wrinkle sensitive; you try to bend the opposite direction, the less wrinkle sensitive. I think maybe some work was done at one point in that area. Did you try to wrinkle the web, or is it something you are leading to? Really, that is the type of problems we fight in industry. It's not a misaligned roller, or a tapered roller, it is a baggy web on a misaligned roller that gets us in trouble and causes wrinkles to happen on one day and not another day.

Name & Affiliation

Ron Swanson, 3M Company

Answer

The shear forces are quite low.

Name & Affiliation

Keith Good, Oklahoma
State University

Answer

We did some experiments several years ago on some cambered webs here at OSU. It just so happened that we unwound the roll and the camber was there. We ran some shear wrinkle experiments on this web, the traditional roll misalignment type of thing. The result was that we found the camber wasn't the major effect. It was the roller misalignment that was inducing the wrinkles. The camber did have a slight effect, but the bigger factor was what you were doing to the web with the misaligned roll. We would run the shear wrinkle test and misalign a roller in a clockwise direction followed by a second test where we would misalign the same roller but in a counter clockwise direction. There was some offset due to the camber but the significant input variable was the roller misalignment and not the camber. I suppose a web with enough camber might increase the offset to where camber would appear more important for wrinkles but thankfully there are some limits to the non-uniformity (camber) that exist in webs.

Name & Affiliation

Neal Michal, Kimberly-
Clark Corporation

Question

Jerry Brown: You commented on that the web edge wasn't skewing. You thought the web was slipping the entire way around the roll. I didn't hear you mention anything about changing tension. Did you try that as well?

Name & Affiliation

Jerry Brown, Essex
Systems

Answer

No, I didn't. With my machine setup it is difficult to manipulate tension. That would be a good thing to do. Maybe I ought to go back and repeat that.

Name & Affiliation

Ron Swanson, 3M
Company

Question

A general question especially for the students: We had several talks today that talked about friction, microslip and contact patches. I wanted to solicit some ideas on how do we model the web going over a roller. The web can be stuck in one spot on the roller surface and not on others.

Name & Affiliation

Jerry Brown, Essex
Systems

Question

The cause maybe differences in the coefficient of friction?

Name & Affiliation

Ron Swanson, 3M
Company

Answer

The cause is probably boundary conditions. The webs are probably partially slipping there. Some of it's stuck, some of it's not.

Name & Affiliation

Jerry Brown, Essex
Systems

Answer

I hope you will read my paper because I really think that is the beginning. The stick zone part, I am very confident of. The microslip is a little tougher because you have this transition from stick to slip. You don't know where that demarcation line is on the roller. I hope people will read that and build on it. There's a few more ideas needed in order to be able to model this accurately. I believe all the basic concepts are there. The particle paths, think of them like streamlines in fluid flow, are certainly going to

determine the direction of motion in the web when you model it. That is the elastic deformation of the web itself and then you have the interaction with friction which you have to bring into the model. I think all the basic concepts are there.

Name & Affiliation

Ron Swanson, 3M
Company

Question

I have thought of this previously in terms of a strip model. Does it account for the neighboring material that is stuck while the outside material is slipping?

Name & Affiliation

Jerry Brown, Essex
Systems

Answer

No. The equations that I developed can apply. You have to decide which set of equilibrium equations apply in a given spot. That is the problem in the modeling. It is kind of like Keith's work in the wrinkling analysis, it has to be an iterative process where eventually the solution converges to a point where you can see where that line of demarcation is. I think the curve that divides the slip and microslip zones can be pretty complicated. It is not a straight line. You can actually have retrograde slipping on one side. It is complicated, but I think all the fundamental concepts are there. There are only two conditions that you can have.

Name & Affiliation

Dilwyn Jones, Emral Ltd.

Comment

Jerry referred to a paper of which I was a co-author that was given at the third IWEB conference in 1995. The paper was done with a colleague at ICI where I used to work. It used a finite element model using ABAQUS. It was just a tension change over a plain roller. While looking at the stress contours you could infer the zones of stick and slip. We could also track the directions of movement and show that the relative movement between the web and the roller was greater toward the web edges. I think using ABAQUS is quite a job. You have to set up the model properly with contact and run enough web through to reach a steady state. There is no way you can right away get steady state condition. You can make models as well for a concave roller, a misaligned roller and so on.

Name & Affiliation

Jerry Brown, Essex
Systems

Comment

I absolutely agree with that. I think a tool like ABAQUS in the university environment could really be put to good use. I am using a PDE solver and it is pretty good, but it is really, really pushing it – I have to think of clever fixes to make it work. I think Dilwyn's work made that point. I think a lot more good results could come out of this to give us the clues we need to build simpler models.

Name & Affiliation

Jan Erik Olsen, SINTEF
Materials & Chemistry

Comment

I think 8-10 years ago, there was a very good presentation by some of the students of Richard Benson. They had taken ABAQUS and they'd rewritten its source codes. They could basically track the web going over forces and lift friction properties and where there were stick and slip zones. I think it was a very good paper, but I haven't seen

anything more come out of it. I think that research group disintegrated. If you don't have the source code, that is going to be a big job to redo the whole thing, but at least it is something worth looking into.

Name & Affiliation

Jerry Brown, Essex Systems

Comment

I agree with you. That is the sort of thing that I think should be going on at OSU. The thing that Benson was trying to do, I don't know how good it was or if it really worked. But the approach to modeling the web with ABAQUS or some way of providing a source and a sink to create a short web so that you don't have to model a long web and require 14 days to get an answer. Some tools like that are badly needed.

Name & Affiliation

Neal Michal, Kimberly-Clark Corporation

Question

So what you are really asking for is a simplified membrane model that would be easy for someone who's not practiced to use?

Name & Affiliation

Jerry Brown, Essex Systems

Answer

I think ABAQUS could be used like an electron microscope to see and understand web behaviors that could benefit simpler models.

Name & Affiliation

Ron Lynch, Procter & Gamble

Question

On Tim Walker's talk on the taxonomy of wrinkles a scheme of applications was discussed. Are there any others that people use or are willing to talk about?

Name & Affiliation

Dave Roisum, Finishing Technologies, Inc.

Answer

I proposed a taxonomy a little bit different than Tim based on observation rather than mechanics because you may receive a wrinkle that is at an angle and know nothing about the history, nothing about the mechanics, yet you already make the conclusion that something is crooked. We ended up approaching it from a different direction based on a user being in a plant as opposed to being a user who is an engineer familiar with web handling and an expert in the subject. But I really struggle, just like Tim is, in language. As authors and teachers, we probably struggle more than any others. Maybe the biggest struggle is the word *buckling*. In fact, all wrinkles are buckled already. That takes in a huge amount of territory, so we have such overlap that it's not just taxonomy. It is actually language itself that is getting in the way. We may need a Carl Linnaeus of web handling to help fix the problem that those of us who have worked in web handling have created.

Name & Affiliation

Ron Lynch, Procter & Gamble

Question

Are there any other categories of wrinkles that were not covered in Tim's presentation?

Name & Affiliation

Tim Walker, T. J. Walker & Associates

Comment

I am definitely collecting wrinkle cause, so if you have a cause I haven't heard about, I would like to hear about it.

Name & Affiliation

Neal Michal, Kimberly-

Question

Tim Walker: What are your thoughts about going forward?

Clark Corporation

Are you publishing this on your website? Will you write a book? Is this something that you are going to publish through AIMCAL?

Name & Affiliation

Tim Walker, T. J. Walker
& Associations

Answer

I am in the midst of finishing a document on taking the causes, going to the root cause and proposing the most common solutions. Before I go too far and publish that, I want to get a little bit of blessing or review that my taxonomy made sense to other people. That is partly the motive of this paper – to check on the structure that I am going to hang a lot of meat on. I have about a 60-page document written, not all on wrinkling, but what happens in buckling.

Name & Affiliation

Bob Lucas, Winder
Science

Comment

In the process of putting together the latest TAPPI book on Roll and Web Defect Terminology, we found you can get really confused because in one part of North America they will have a totally different language for what they call certain defects compared to another part of the country. It might vary from mill to mill, so when you go in these mills, production plants, you suddenly have to become accustomed to a whole new vocabulary because they have their own contrived names for various defects. Part of the effort was to try to collect some of these names if only to create some kind of lexicon to allow people to cross-reference and recognize some of these names. It takes time to sort these names out. When I go into a plant I have to shift vocabularies to suit the local environment because that's what they call it. Not everyone knows what a crow's foot wrinkle is but that's what one mill calls something. It can be both interesting and frustrating.

Name & Affiliation

Neal Michal, Kimberly-
Clark Corporation

Comment

You definitely have to use their language; otherwise you have to re-explain yourself every time.

Name & Affiliation

John Shelton, Oklahoma
State University

Comment

I agonized when presenting a paper to the Web Handling Research Center and later presenting it to IWEB about something as simple as corrugations and troughs. I was calling web buckles in a free span *troughs*. Then I got to thinking about the old fashioned corrugated sheet metal is what we were looking at – what we've been making for more than 100 years. So *corrugations* could be used to describe web buckles in free spans as well.

Name & Affiliation

Dave Roisum, Finishing
Technologies, Inc.

Comment

That may be the most common laymen's language use of the word corrugation. The most common use in the web industries at large is for a wound roll defect which is also called tin canning which is different buckling defect. It is a really big mess.

Name & Affiliation

Tim Walker, T. J. Walker

Comment

On corrugations in sheet metal you are talking about a

& Associates

permanent shape change. In general, web troughs are not a permanent shape change. It is a temporary affect that when you leave the web alone, it returns to its flat or cambered state. When a wound roll has tin can buckles sometimes it is a permanent defect and sometimes it is not. The word corrugation, if you look it up in the dictionary or engineering textbook, it doesn't necessarily define it as being a permanent feature. No one says that the shirt I am wearing is corrugated – but I don't say it's troughed either.

Name & Affiliation

Ron Lynch, Procter & Gamble

Name & Affiliation

Paul Weber, Kimberly-Clark Corporation

Comment

You can have one trough, but I don't know if you can have one corrugation.

Question

Dr. Good: You presented Poisson's ratios for 3 materials in Table 1 of your paper. The one that jumps out at me is for the spun bond nonwoven with a Poisson's ratio of 0.3. We see a wide variety of Poisson's ratios in the materials that we run from .1 to 3-4. Where did the .3 for your spun bond come from? How do you think the differences that some of these higher or lower Poisson's ratios will affect these results?

Name & Affiliation

Keith Good, Oklahoma State University

Answer

First of all, regarding that table, when I presented those properties I was developing orthotropic theory for troughs and for shell buckling. If you look at how Poisson's ratio enters those relationships, for webs that have Poisson's ratios of .4 and less, they have little impact on trough and wrinkle stresses and wavelengths. Now, how did we come to the values that are in the table? It is really hard to measure Poisson's ratios for any of those materials, whether they are nonwoven or not because they are prone to trough in testing. So it is not apparent how much of the lateral deformation is the in-plane deformation that is related to Poisson's ratio and how much of it is a width reduction due to out-of-plane deformation that occurred due to the trough. For the properties we introduced in Table 1 we made an assumption of 0.3 for one of the Poisson's ratios. Then the constitutive relationships demand symmetry, Maxwell's relation states $\nu_{yx}/E_y = \nu_{xy}/E_x$. That is where the Poisson's ratio ν_{yx} came from that was in Table 1. For the web materials that have apparent Poisson's ratios that are large, there are expressions that have terms like $(1 - \nu_{yx} \nu_{xy})$ in the denominator that can become ill conditioned and violate physical reality. If this occurs the traditional constitutive relations that you used in the past are no good for your particular material. When you have a web exhibiting a severe lateral contraction in the CMD due to an MD strain, it might appear that the web has a Poisson's ratio of 3 or 4. But in fact you may be mistaking a structural effect with a material property. In nonwovens you

have a lot of fibers that are distributed in various directions, you are putting machine direction tension on them, and yes, they collapse sideways. If you took one of those individual fibers and pulled on it, it would have the Poisson's ratio of .3-.4, approaching .5 when it goes plastic.

Name & Affiliation

Bob Lucas, Winder
Science

Comment

I was associated with a fellow named Jan Bergstrom who worked long ago for STFI. He made a macro model of paper made up of hoses and hose clamps to try to simulate the structure, a hypothetical structure of paper. He put it under tension as if he was simulating paper under tension and the caliper thickness increased when he put it under tension. All the fibers were realigning as each of them came under load. It does adapt for low tension as everything came under load. It was a very tedious effort on his part to try to structurally simulate fiber orientations and fiber bonds that exist inside the thickness of paper.

Name & Affiliation

John Shelton, Oklahoma
State University

Comment

Bob Lucas: Dave Roisum and I (when he as a student here) picked up a collator and talked about the apparent Poisson's ratio of a collator. This is strictly a mechanical and not a material behavior. It is nonlinear, its height varies nonlinearly as you extend it. I may have circumvented this problem though in my narrow field of work in recent years in using E/G for defining the change in width with the change in length. That eliminates division by zero and I think it is a usable thing for the lateral behavior that I have been dealing with in recent years.

Name & Affiliation

Keith Good, Oklahoma
State University

Question

John Shelton: Wouldn't you say that in most cases it is as hard to measure the shear modulus for the web as it to measure Poisson's ratio? If the web troughs the shear modulus will appear artificially low.

Name & Affiliation

John Shelton, Oklahoma
State University

Answer

It may be. I never have tried.

Name & Affiliation

Tim Walker, T. J. Walker
& Associates

Comment

I was talking to Keith Good earlier about an observation I had made a while ago on a lot of equations where you see stress and modulus. Sometimes the equations are simpler if left in terms of strain. Keith said that it really does not solve the problem because in a web line people often infer strain from web tension and modulus. Many web behaviors are easier to understand if you start with strain and eliminate tension and modulus.

Name & Affiliation

Ron Lynch, Procter &
Gamble

Comment

I agree with that. It is very helpful to think about strain and displacements rather than the forces that created them. You can have an example of a tapered web running on a tapered roller. You would have unusual stress profile, but you may have the same strain profile across the width of that web. It

would seemingly run straight through the machine. Take that as an example.

Regarding the troughs and waves that form in nonwovens when you try to measure the web properties: This is related to the measurement method and the method of constraint. Often property measurement involves clamping the ends of a web coupon and subjecting it to tension. That creates the stress profile that causes that waviness. A web in a free span running over aligned rollers has no lateral clamping and there are no troughs, but you do still see large strain changes.

Name & Affiliation

Tim Walker, T. J. Walker
& Associates

Question

Wouldn't that be the way to measure Poisson's ratio in these materials? Don't make measurements in the middle of the span where the troughing is, but on rollers where the web has contracted but troughs are eliminated. Would that not yield the correct Poisson's ratio?

Name & Affiliation

Keith Good, Oklahoma
State University

Answer

Tim Walker: Theoretically you are correct but now you have added the complexity of making dynamic measurements of strain in a web crossing a roller to infer Poisson's ratio.

Paul Weber: Maybe a better answer to your question is that you really need to change your modeling methods at some point. Yes, you can measure this apparent Poisson's ratio that looks bigger than .5 and maybe is as big as 5, but you are still stuck when you start trying to use a D matrix (relating the vectors of stress versus strain) in a finite

element that has a factor $\frac{E}{1-\nu^2}$. What this tells us is that

when we move to these materials that those simple plain stress constitutive properties that are integral in the stiffness matrix development are inadequate and that you have to have a different kind of stiffness matrix now that incorporates the properties of the nonwoven and are allowed to contract more than the old plane stress equivalent would.

Name & Affiliation

Balaji Kandadai,
Kimberly-Clark
Corporation

Comment

There was a great dissertation that was published 10-15 years ago at NC State. They had used a completely different approach in modeling nonwovens. They used a composite theory. They would model a nonwoven structure as a layer of fibers oriented in different directions. They were able to get pretty good results in terms of how much the final measurement would be when you strain it. The challenge was that all their models were static models. How do we apply that to dynamic cases? That is a challenge for the next IWEB.

Name & Affiliation
Ron Lynch, Procter &
Gamble

Comment
Part of the problem is most of those materials are based on the assumption that the material is a solid and has a relatively constant volume and that is not the case for nonwovens. They have different properties. You can measure those properties and come up with numbers for them, but in a lot of cases, they don't fit in the classic equations because of the assumption that they were solid materials. We need an extra set of models that deals with some of those.