

1964R/M61  
2945

Name: Gordon Ryan Meyers

Date of Degree: May 24, 1964

Institution: Oklahoma State University Location: Stillwater, Oklahoma

Title of Study: MECHANISMS INVOLVED IN THE ABSORPTION OF IONIZING RADIATIONS IN BIOLOGICAL SYSTEMS

Pages in Study: 32

Candidate for Degree of Master of Science

Major Field: Natural Science

Scope and Method of Study: This report is intended as a brief survey of the physical mechanisms involved as ionizing radiations are absorbed within a biological system. It is a survey of the recent literature as presented by radiation biologists, physicists, and chemists. Although the survey is not intended to be a comprehensive treatise, it cites examples of the various mechanisms involved. Both primary and secondary ionizations are discussed as well as the effects which they may have on specific body compounds. The radiation mechanisms are traced from incident photons to the ionization of organic compounds. Within the scope of the study are the mechanisms of direct and indirect action. In addition, discussions of the oxygen effect and temperature effect are included. Brief recognition is given to the nature and value of protective chemical compounds.

Findings and Conclusions: Ionizing radiations would appear to create disturbances within the living organism which are extreme, considering the amount of energy absorbed. Consideration of the sequence of events which occur following the energy absorption, however, will reveal the cause for the dramatic effects which result. Although the energy absorbed seems insignificant, its action is directed toward the ionization of body compounds. It is this series of ionizations and the chemical events following the ionizations which account for the characteristic radiation syndrome. Chemical changes which occur due to the ionizations produced, result in structural changes which may range from short-lived reversible reactions to those which are so drastic as to be totally irreversible. When this is considered in terms of the possible structural changes in the cellular components we begin to see the reasons for the pronounced disabilities manifested in the organism. The recipient of this energy may be as simple as the water molecule or as complex as the nuclear proteins. Thus the results may range from an undetected change to the death of the organism. Even the undetected alterations may appear symptomatically in the future of the organism or the organism's descendants.

ADVISER'S APPROVAL

L. Herbert Benson

MECHANISMS INVOLVED IN THE ABSORPTION OF IONIZING  
RADIATIONS IN BIOLOGICAL SYSTEMS

By

GORDON RYAN MEYERS

Bachelor of Arts

State College of Iowa

Cedar Falls, Iowa

1958

Submitted to the faculty of the Graduate School of  
the Oklahoma State University  
in partial fulfillment of the requirements  
for the degree of  
MASTER OF SCIENCE  
May, 1964

MECHANISMS INVOLVED IN THE ABSORPTION OF IONIZING  
RADIATIONS IN BIOLOGICAL SYSTEMS

Report Approved:

*H. Herbert Brunson*

---

Report Advisor

*Robert C. Fite*

*James MacLinn*

---

Dean of the Graduate School

## PREFACE

By 1909 scientific evidence had been gathered that indicated pathological effects due to repeated exposures to X-rays. Pioneer radiologists, frequently exposed to X-rays, developed a dermatitis condition. More disturbing evidence followed as the dermatitis was linked to the appearance of warts which eventually became malignant. Even when all exposure to the radiations was stopped the changes continued and the malignant cells were found to appear up to thirty years later.

With the development of nuclear research leading to man's control of nuclear fission came an increasing interest in the phenomena associated with ionizing radiation and its effect on life. Both corpuscular and electromagnetic radiations, when absorbed by the body, were found capable of causing profound changes in the environments of the cell as well as modifying the structure and nature of the cellular components.

The fact that ionizing radiation will be generally harmful to biological systems is now common knowledge. Not so common, however, is the understanding of the mechanisms involved as the radiations are absorbed and cause the damage.

It is the purpose of this report to explore and illustrate the most modern scientific thinking on the mechanisms involved in the absorption of ionizing radiation by the living organism. A study of these mechanisms should then allow application of these concepts to facilitate a

better general understanding of the reasons for the changes which occur and are manifested in the radiation syndrome.

Indebtedness is acknowledged to Dr. L. H. Bruneau for his guidance in the formulation and completion of the study.

## TABLE OF CONTENTS

Chapter	Page
I. TYPES OF RADIATION . . . . .	1
II. THE IONIZING EFFECTS OF X-RAYS OR GAMMA RAYS . . . . .	4
III. STAGES OF ABSORPTION AND EFFECT. . . . .	8
IV. DIRECT AND INDIRECT ACTION . . . . .	10
V. THE ACTIVATION OF WATER. . . . .	12
VI. THE OXYGEN EFFECT. . . . .	16
VII. ADDITIONAL FACTORS ALTERING EFFECTS. . . . .	19
VIII. ENERGY ABSORPTION BY ORGANIC MOLECULES . . . . .	22
IX. SUMMARY. . . . .	30
BIBLIOGRAPHY. . . . .	32

## LIST OF FIGURES

Figure	Page
1. Types of Ionization Mechanisms as Produced by X or Gamma Radiation. . . . .	5
2. Alpha Particle . . . . .	13
3. Enzymes Containing Sulfhydryl Groups (SH). . . . .	27
4. Changes in the Macromolecular Properties of DNA Brought About by ionizing radiations . . . . .	29

## CHAPTER I

### TYPES OF RADIATION

Alexander (1959), for the purpose of their discussion, divides ionizing radiations into two categories: electromagnetic, including X-rays and gamma-rays; and corpuscular, including beta rays (electrons), alpha rays (helium nuclei), protons (hydrogen nuclei), and neutrons. The distinction is made at this point to emphasize the particulate nature of corpuscular radiation which in some cases greatly limits its ability to penetrate the external surface of an organism.

X-rays, gamma rays, and neutrons represent the most commonly employed external sources of radiation. Gamma rays may be a hazard either from an internal or external consideration since they are highly penetrating electromagnetic radiation associated with the decay of radioactive elements. Alpha and beta particles are also associated with the decay of radioactive elements but due to their inability to penetrate the body covering are generally only of concern when ingested or inhaled.

All of the above examples of radiations, whether corpuscular or electromagnetic can be considered to exert an ionizing effect. Their energies are absorbed by the electrons present in the body compounds, enabling the electrons to escape from the parent compound. This in turn forms ions and radicals which will be of importance in the discussion at a later point.



X-rays and gamma rays are almost entirely absorbed by transferring their energies to electrons. The electrons thus energized have an increased kinetic energy which enables them to escape from the parent compound or atom. If their kinetic energy is sufficient, these electrons may then be capable of ejecting other electrons - a process referred to as a secondary ionization. The subsequent ionizations following the primary ionization are of course dependent on the amount of energy which the ionizing radiation imparts to the electron which it initially strikes. The energy of the ionizing radiation is generally much greater than that necessary to ionize an atom, so the excess energy is either stored in the first electron as excess kinetic energy or the ionizing radiation may distribute its energy over several electrons before being dissipated. Thompson (1962) points out that as much as 75 per cent of the total energy of the absorbed radiation may be dissipated as heat. He also stresses, however, that from a quantitative point of view the temperature increase in mammals following the absorption of a lethal dose of radiation is only a few thousandths of a degree. This would seem to indicate a tremendous chemical activity due to the irradiation being the cause of lethality.

The corpuscular radiations, according to Alexander (1959) have a similar tendency to ionize elements and compounds by ejecting electrons from the parent compounds. In this case, however, we are dealing with the kinetic energy of one particle being transferred to another particle through collision. Since the corpuscular radiation energies are due to the kinetic energy which they possess, their mass must be considered as a factor. In short, if two particles of unequal mass are traveling at the same velocity, the larger will possess more kinetic energy than the smaller. This will in turn effect the number of ionizations which these

particles will produce. For a more complete understanding of all of the ramifications of particulate masses and energies associated with ionization the reader is directed to the topic of linear energy as described by Thompson (1962).

The neutron is a corpuscular radiation which due to its unique properties merits special consideration. The particle is of neutral electrical charge with approximately the same mass as the hydrogen nucleus. Since the particle is neutral in its electric charge, it is neither attracted nor repelled by nuclei or their orbital electrons. (Lapp and Andrews, 1963)

Neutrons do not produce ionizations directly. High energy neutrons may eject protons from the nuclei which they strike. Slower neutrons are frequently absorbed by atomic nuclei and create unstable nuclei. The unstable nuclei then release their excess energy as beta particles or gamma rays. The resultant products in either case may then act in their characteristic manner to produce ionizations. (Thompson, 1962)

## CHAPTER II

### THE IONIZING EFFECTS OF X-RAYS OR GAMMA RAYS

Although the corpuscular radiations can be important from the standpoint of ingestion or inhalation of radioactive materials and also from the standpoint of neutron irradiation from an external source, they are somewhat secondary in importance to the electromagnetic radiations. The reasoning behind such a determination of course lies in the fact that X-rays and gamma rays do more damage because of the relative frequency with which they are encountered. Both types are an external radiation hazard, being able to penetrate the body covering. Although the neutron is also capable of such penetration, it is not frequently encountered other than in research which entails the use of a free neutron source.

It is probably worthwhile at this point to discuss the known mechanisms by which the radiant or photon energy of the electromagnetic radiations is transformed to the kinetic energy of the free electrons. Lapp and Andrews (1963) divide these mechanisms into three important types. They are: photoelectric effect, Compton effect, and pair production. Although other types of mechanisms are known, these are the most frequently encountered.

The photoelectric effect occurs when an X-ray or gamma ray photon strikes an atom. When it impinges on an orbital electron, the energy of the photon is transferred to that electron. A portion of the energy of

## Photoelectric Effect

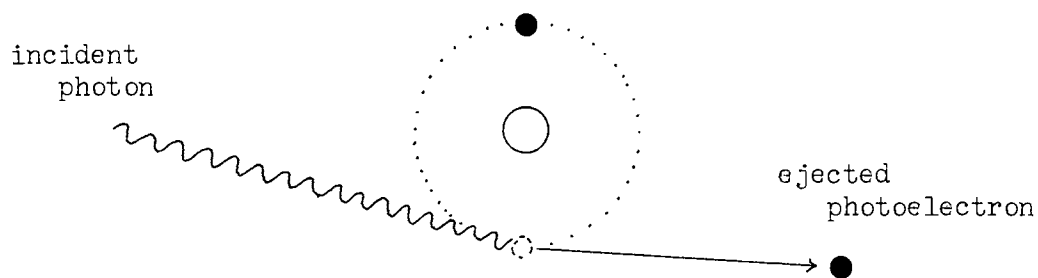

## Compton Effect

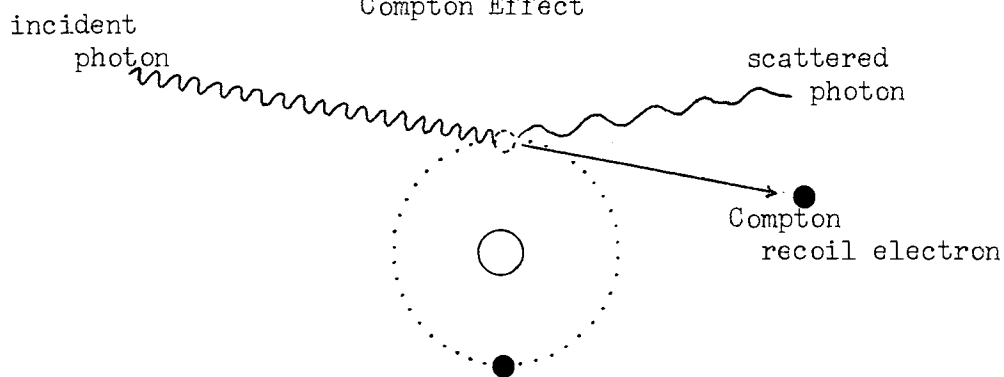

## Pair Production

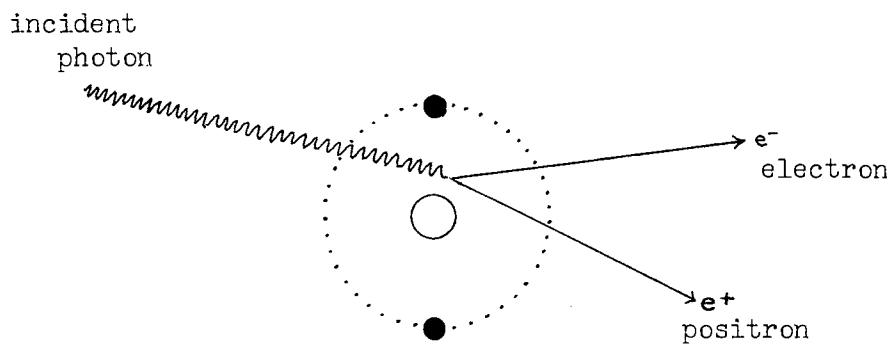

Fig. 1. Types of Ionization Mechanisms as produced by X or gamma radiation. (Lapp and Andrews, 1963)

the photon is utilized to eject the electron from its orbit. Energy of the photon in excess of the amount needed to eject the electron from its orbit is imparted to the free electron as kinetic energy. Electrons ejected in this manner are called photoelectrons. These electrons, being produced by a process which completely absorbs the energy of the incident photon, may possess considerable kinetic energy. The photoelectrons then become a source of ionization and will strip electrons from neighboring atoms.

The Compton effect differs from the photoelectric effect primarily in the tendency of the incoming photon to yield only a portion of its energy to the electron which it initially strikes. The photon strikes the electron giving up a part of its energy and continues on as a lower energy photon which may repeat the process until the energy of the photon is dissipated. The electrons removed from their atoms in this way are called recoil or Compton electrons. The discoverer of this phenomenon, A. H. Compton, considered the collision between the original photon and an electron to be an elastic collision between two masses.

Pair production is an effect which will occur when the incident photon is above a 1.02 Mev threshold. Since this represents a high energy photon value it only occurs with a very high energy electromagnetic waves. This effect illustrates a very short-lived conversion of energy to matter with the almost immediate reversal of the process wherein the particles are converted back to photons. The incident high-energy photon entering the charged field of an atom's nucleus or its orbital electrons may disappear, yielding its energy to the creation of a positron-electron pair. Almost the total energy of the photon is given up to the pair production. The positron and the electron then may cause ionizations

until their kinetic energy drops to a lower level. When the kinetic energy of the positron drops off to a low level, the positron will be attracted to and combine with an electron and go through a process which is the reverse of that by which it was created. The positron and the electron combine and are annihilated. In their place are created two gamma rays which move off in opposite directions and produce ionizations as they are dissipated.

It would seem to the casual observer of this process that this might result in a chain type reaction where photons produce pairs and pairs produce photons which in turn produce more pairs. Attention should be directed therefore to the consideration of the energies involved. A 1.02 Mev photon gives rise to a pair production, this pair in turn at a maximum gives rise to two annihilation photons of .51 Mev each moving off in opposite directions. Therefore neither of the gamma rays produced will have sufficient energy to initiate another pair production.

Pair production, since its discovery, has given some impetus to the anti-matter theories espoused of late by a number of theoretical physicists.

Although photoelectric effect, Compton effect, and pair production can be contrasted on the basis of energy of the incident photon and the consequent ionization activities, emphasis should be pointed to the fact that all three types of activity have as their product, ionizations of the matter into which they have been absorbed.

## CHAPTER III

### STAGES OF ABSORPTION AND EFFECT

To this point the chief concern has been pointed toward the physical mechanisms which will produce ionizations. Now, however, it is well to focus attention on the broad spectrum of events which will follow these ionizations.

Platzman (1959) divides the events into four stages: the physical stage, the physicochemical stage, the chemical stage, and the biological stage.

The physical stage corresponds to the previous discussion of the ionizing radiations and their methods of producing ions and free electrons.

The physicochemical stage is a period during which the primarily ionized products will undergo secondary reactions. The ions collide and react with normal molecules, forming excited molecules which spontaneously dissociate. During the very brief time span of this stage, physicochemical changes will yield stable molecules, some of which may differ chemically from the original molecules, and molecular fragments, which are called free radicals.

The third or chemical stage finds the free radicals reacting with themselves and also with other molecules present to produce the final chemical products formed by the foregoing series of events.

The fourth stage, occurring only in biological systems, is the stage in which the biological organism responds to the foreign chemical substances which are the products of the chemical stage. This stage may persist for days or even years.

The time span of the first three stages is extremely short. In biological tissues Platzman (1959) estimates the physical stage to require  $10^{-13}$  second, the physicochemical stage about  $10^{-11}$  second, and the chemical stage to range between  $10^{-6}$  and  $10^{-9}$  second.



## CHAPTER IV

### DIRECT AND INDIRECT ACTION

Platzman's (1959) description of the various stages of activity due to the absorption of radiation in biological systems is of considerable value as a broad overview. It must be scrutinized more closely, however, to yield an understanding of the processes involved.

In order to consider some of the fundamental reactions taking place during the physicochemical, chemical, and biological stages, the concepts of direct and indirect action are presented at this point.

Alexander (1959) explains that it is probably safe to assume that equal weights of the many compounds making up the body of the living organism take up the same amount of energy from a given dose of radiation. Since the water content of the organism will make up as much as 85 per cent of the body weight, most of the energy will be initially deposited in the water. Lesser amounts of the energy will be absorbed by the other various substances which are present in lesser amounts.

The energy taken up in the water serves to activate the water, forming ions and radicals, which in turn will then react with dissolved substances or other materials with which they come in contact.

Chemical changes produced by the reactions of activated water molecules is referred to as indirect action. Since water is found in rather high concentrations around the essential structural and metabolic components of the cell, this action is of considerable significance.

The same structural and metabolic components of the cell may of course be changed by direct action. In this case the ionizing radiations are absorbed directly and ionize the substances they strike.

Although either direct or indirect action may create the same effect, it should be emphasized that the indirect action is more probable since the water presents a much greater target area.

## CHAPTER V

### THE ACTIVATION OF WATER

Alexander (1959) emphasizes the importance of the absorption of ionizing radiations by the water of a biological system. The reasons for its importance have been stated previously.

Since the indirect action of the activated water is of such importance it will be treated here in some detail. Platzman's (1959) diagrams will be utilized to allow a greater ease of understanding of the verbal description.

The theories concerning the mechanisms involved in the activation of water were established as early as 1929 and have now been confirmed. Alexander (1959), Dainton (1955) and Bacq (1961) seem to be in general agreement on the mechanisms involved.

As the water is radiated, it splits into free radicals.

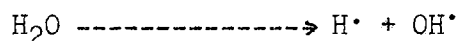

These products are highly reactive because they lack the stable electron which they possessed in the water molecule. To become stable the  $\text{H}\cdot$  must lose an electron to become  $\text{H}^+$ , the hydrogen ion, and  $\text{OH}\cdot$  must gain an electron to become  $\text{OH}^-$ , the hydroxyl ion. The hydrogen ion and the hydroxyl are relatively stable and non-reactive.

The great reactivity of the radiated water is due to the radicals formed. These radicals will attack most organic molecules in order to

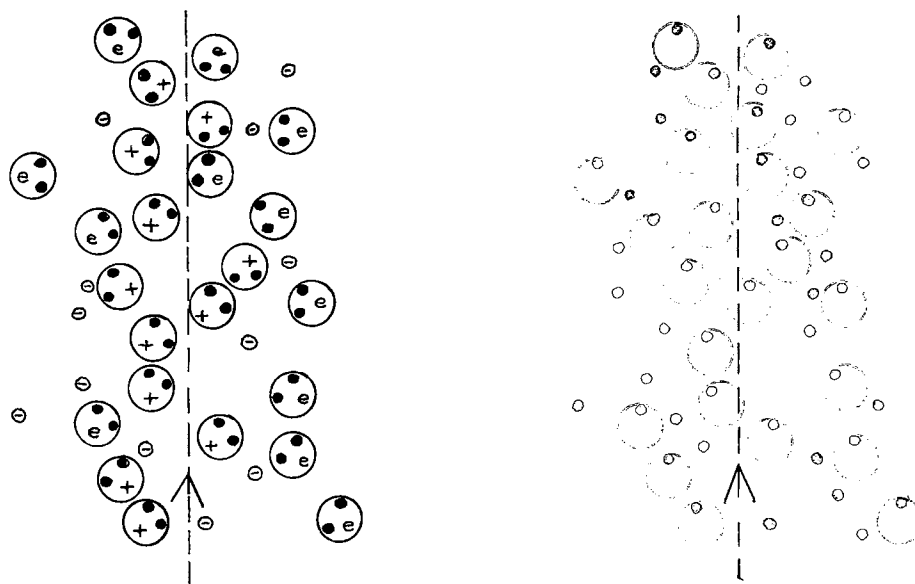
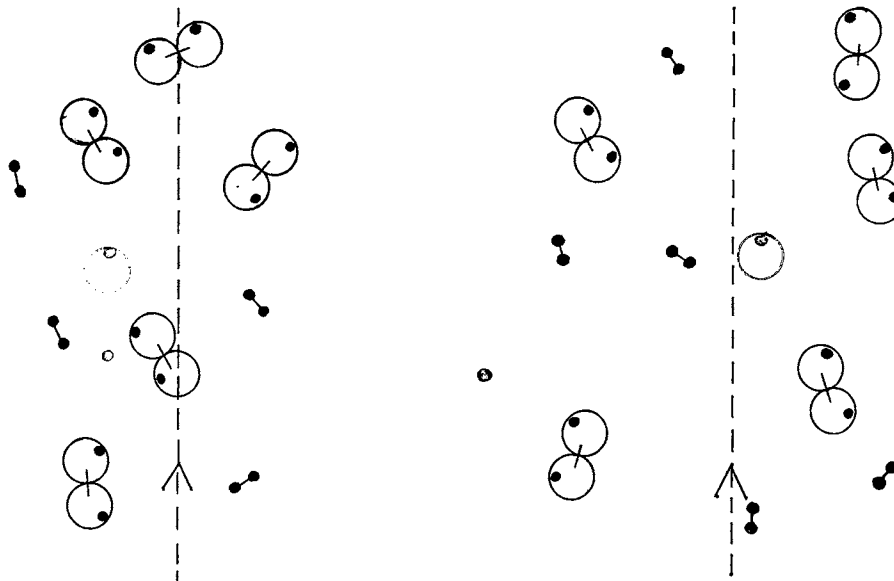
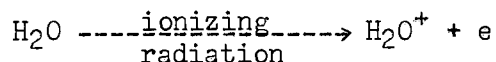

Fig. 2. ALPHA PARTICLE with an energy of six million electron volts decomposes water according to this scheme. The first drawing depicts the end of the "physical" stage, lasting about  $10^{-13}$  second. In the wake of the particle are excited water molecules (e), positive water ions (+) and electrons (-). Normal molecules are not shown. The second drawing depicts the end of the "physicochemical" stage, lasting about  $10^{-11}$  second. Hydrogen atoms (colored dots) and hydroxyl radicals (colored



circles with dot inside) are now in the wake. The third and fourth drawings depict the "chemical" stage, which may last  $10^{-9}$  to  $10^{-6}$  second. Some of the hydrogen atoms and hydroxyl radicals have recombined into normal water molecules (not shown); others have formed hydrogen molecules (paired dots) and hydrogen peroxide molecules (paired circles with dots inside). (Platzman, 1959)

attain a stable electron configuration. Of course, the radicals may also combine with each other. The radical formation takes place as the ionizing radiation passes through the water ejecting an electron from a water molecule.



The electron is then captured by another water molecule to produce a negative ion,

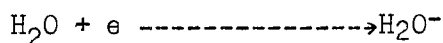

and this completes the formation of an ion pair. Neither of these ions is stable and they decompose almost immediately according to the following pattern:

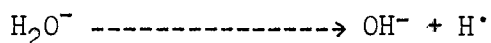
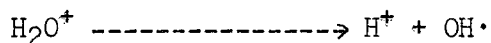

This decomposition yields two free radicals and two stable ions. The ions will recombine to form water.

Indirect action for the most part is the result of the reactions of the  $\text{H}\cdot$  and the  $\text{OH}\cdot$  radicals with organic molecules. Of course the reactions with the organic molecules are in competition with the recombination of the radicals to form water, hydrogen gas, or hydrogen peroxide. Neglecting the reactions with the organic molecules for the present, the reactions of the radicals are of the following possibilities:

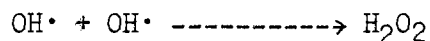
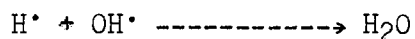

The hydrogen peroxide is a stable molecule but can nevertheless react with many substances. Therefore its formation within the sensitive cell structures will contribute to the possibility of radiation damage.

Thompson (1962) makes an interesting observation on the time consumed by the reaction of the radicals. It has been estimated that within  $10^{-2}$  second after the passage of a particle or photon induced electron through an aqueous medium, the free radicals  $H\cdot$  and  $OH\cdot$  are formed. In less than a microsecond these radicals have either recombined to form water, combined with identical radicals to yield molecular hydrogen and hydrogen peroxide, or reacted with solutes present in the system. As might be expected, a high concentration of solutes within the system will reduce the probability of water, hydrogen, and hydrogen peroxide formation.

## CHAPTER VI

### THE OXYGEN EFFECT

According to Alexander (1960) the changes produced by X-rays and gamma rays in all kinds of living matter are much greater in the presence than in the absence of oxygen. There seems to be no question among radiation research specialists that this phenomenon occurs. However, considerable disagreement and understanding exists as regards the mechanism or mechanisms by which oxygen exerts its effect.

Thompson (1962) generally leans toward the theories of Hallaender, Bacq, and Alexander which support rather strongly the utilization of oxygen in indirect action. These proposals indicate that if molecular oxygen is present in the tissues during irradiation, it will react very quickly with the  $H\cdot$  radical of activated water.

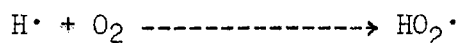

The product of this reaction ( $HO_2\cdot$ ) is the hydroperoxyl radical. This radical is extremely reactive and will contribute to the total action of the other radicals in activated water by reacting with organic molecules.

There seems to be an optimum point for the oxygen effect. Increasing the oxygen content of the normal atmosphere does not increase sensitivity to the radiation. Reducing the oxygen content in the organism's environment, however, decreases the sensitivity to the radiation. Most studies therefore on oxygen effect are actually studies dealing with the contrasts

in sensitivity to radiation between organisms with normal oxygen tension in the tissues and organisms that are rendered anoxic.

A great number of studies have been made concerning anoxia and its effects in decreasing sensitivity. Typical statistical data and experimental design are well presented in the proceedings of the International Conference on Radiobiology which met in England during 1955. The research data presented at that time is published under the title Progress In Radiobiology and this publication is included in the bibliography of this report.

Alper (1960) has formed an hypothesis which considers the oxygen effect to be a predominant part of a direct action. He postulates that the energy of the radiation is absorbed by a cellular component and the fate of this component is then determined by its environment.

If molecular oxygen is available in the environment, it may combine with the structural component and irreversibly alter its composition. Alper further states that if the oxygen were removed or the structural component were protected from the oxygen by protective chemical compounds, the oxygen would not combine with the component. Thus the ionized cellular component would be favored to return to its original state.

At present, the proponents of both hypotheses admit the lack of a clear cut proof. However, even in the absence of proof for either or both mechanisms certain generalizations are substantiated by research. Alexander (1959) summarizes them as follows:

1. The remarkable feature of the oxygen effect is its universality; it applies equally to the lethal dose for animals, the production of chromosome breaks in bean root or pollen grains, the killing of tumor cells or bacteria, and the production of mutations in fruit flies.



2. The oxygen must be present during the irradiation itself, and the radio-sensitivity is unaffected by changes in oxygen immediately after irradiation.
3. The biological effect from densely ionizing radiations such as alpha rays or neutrons is independent of oxygen. The effect is only observed with sparsely ionizing radiations such as X-rays, gamma rays, or beta rays.

## CHAPTER VII

### ADDITIONAL FACTORS ALTERING EFFECTS

In addition to the variation of effect produced by the relative concentrations of oxygen which may be present in the tissues, there may be other factors which should be considered when assaying the total damage.

According to Cronkite (1960), these factors may or may not be allied with the oxygen effect. Presumably one of the factors which is related to the oxygen effect is the temperature at which the tissues are irradiated. Irradiating biological tissues at reduced temperatures seems to delay the biological effect until the tissues are returned to room temperature. In some cases, it would appear that when tissues are radiated at reduced temperatures the amount of biological damage is actually reduced.

Alexander (1959) cites experiments with small mammals in which the mammals were cooled to a temperature of two to three degrees Centigrade and were irradiated at that temperature. They were found in these cases to be truly radiation resistant, even for a time after being warmed to normal temperatures. Sensitivity to radiation was so reduced as to allow these animals to tolerate two to three times the usual lethal dose.

The reason for the apparent resistance in these cases of extreme hypothermy or for periods shortly thereafter is generally credited to the fact that the oxygen tension in the tissues is significantly reduced when

the tissues are at reduced temperatures. This resistance is actually an indication of the prominent role which oxygen can play in radiation damage.

Another important consideration as stated by Cronkite (1960) is the relative proportion of non-essential materials present which substitute as targets for the essential cellular components. It has been shown that amino acids, sugars, and proteins as well as a wide variety of inorganic substances may prevent damage to enzymes. This protection is presumably afforded through a mechanism of competitive inhibition.

Competitive inhibition is simply the mechanism involving the added molecules actively competing for the active radicals formed by the radiation. With this competitive molecule present, the number of radicals available to damage the molecule of primary interest is reduced.

Competitive inhibition has been the basis for exhaustive studies concerning the value of various chemicals to be used as protective agents. Thompson (1962) explores the possibilities of chemical protection rather thoroughly. He explains that a number of chemical compounds have been found which may serve as an internal shield or absorbing mechanism for the activated products and thus reduce the number of chemical lesions or repair them. Among the most successful have been a number of the thiol compounds.

According to Cronkite (1960), a chemical protective agent should possess two chemical properties. It should be easily oxidized by the free radicals in order to remove the free radicals from the medium. It should not, however, be easily oxidized by the oxygen existing in the environment since this would obviously reduce its availability for free radical capture.

In general the hope for a practical application of the competitive inhibition action of chemical agents has been somewhat dimmed. Thompson (1962) cites two limiting factors in their use. First, these agents are preventatives and as such must be administered to the organism prior to the absorption of the radiation. Second, a number of the chemical agents when administered in amounts which would significantly reduce the sensitivity to radiation have in practice been found to be relatively toxic.

In consideration of the experimental results, the value of chemical inhibitors is rather limited.

## CHAPTER VIII

### ENERGY ABSORPTION BY ORGANIC MOLECULES

In discussing the ionization of water, disagreements begin to arise on the mechanisms involved. These controversies concern themselves primarily with the role of oxygen and its involvement with the direct or indirect paths of action. At this point the reader sees an indication that although much has been observed, much is also left to be determined.

If this is disconcerting, the following discussion may create some dismay. It was possible during the previous discussions to rather accurately describe the mechanisms involved. Such accuracy was possible primarily due to the relative simplicity of the substances involved.

Now, however, it becomes necessary to carry the mechanisms into the organic components of the cell. This will involve a myriad number of compounds of varying complexity.

Cytological investigations have not completely established the actual composition and physiological functions of a number of the cellular structures. The concern for this lack of understanding at this point is due to the need for such knowledge in order to recognize changes in structure and function which may be induced by radiation damage.

Bacq and Alexander (1961) point out the fact that a great deal of information has been accumulated concerning the physico-chemical changes which occur in macromolecules due to both direct and indirect action.

They hasten to admit, however, that the chemical reactions which lead to these changes have rarely been established.

A simplified approach to the effect of energy absorption in organic molecules is presented by Thompson (1962). Indirect action, according to this author, is due to the free radicals formed when water is activated. As stated previously, these radicals are extremely unstable and short-lived. Their method of disturbing the cell is not fully understood. They may either react directly with vulnerable cell components to initiate the chain of events leading to radiation injury, or they may oxidize some intermediate compound such as a fatty acid. In the event of fatty acid oxidation, although the fatty acid does not constitute an irreplaceable cellular component, such an oxidation gives rise to a peroxide. Despite the peroxides tendency to be less reactive than the radical, it is capable of diffusing a greater distance from the site of ionization to produce a damaging effect.

In contrast to the indirect action, as described by Thompson, the direct action would amount to a direct ionization of the vulnerable cellular component. Naturally, either or both types of action are possible in biological systems.

Although generalizations such as given above have a value in presenting a broad overview, a glimpse into the recent research reveals that terminating the discussion with such an overview might result in a lack of appreciation for the complexities involved.

Bacq and Alexander (1961) make a more detailed explanation involving only the complex macromolecules of the cell. They justify the consideration of macromolecules specifically on the basis that due to the proportion of damage inflicted they are the most significant target.

Consider the relatively small ATP molecule and the large myosin molecule. Both must be present for normal muscle contraction. They are present, however, in greatly different proportions, the ATP molecules being far more numerous. Since the ATP molecules exist in greater numbers than the macromolecules of myosin, a given amount of radiation will change a much greater proportion of all the macromolecules than of the total smaller molecules. Therefore, the proportion between the myosin and ATP molecules will be increased in favor of the ATP, but the result will be a lack of function due to shortage of myosin.

Hollaender and Stapleton (1959) emphasize the need for consideration of relative numbers of a specific molecule or structure present in the cell. It is their observation that the cytoplasm's tendency to be more resistant to radiation than the nucleus is probably related to the fact that it contains many multiples of each of its important structures. The nucleus, in contrast, rarely possesses more than one or two sets of chromosomes, its most important components.

In the interests of at least presenting a pattern of chemical reactions which might be expected to occur, it is probably worthwhile to present Bacq and Alexander's (1961) general discussion of the action of ionizing radiations on the organic compounds.

The principal initial reaction is the abstraction of hydrogen from the molecule due to the presence of the  $\text{OH}^\bullet$  radical.

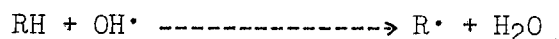

In the absence of oxygen,  $\text{R}^\bullet$  can react with another radical ( $\text{X}^\bullet$ ) and if ( $\text{X}^\bullet$ ) is a hydrogen, restoration has occurred.



Another situation arises if the organic radicals join with each other in a dimerization.

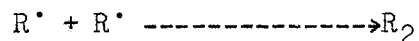

The radicals may also rearrange by joining with one another and following such a rearrangement give rise to two or more new products.



In biological tissues, however, where oxygen is present, one of the prominent reactions is:

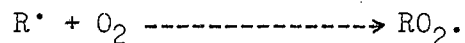

In many cases the fate of the  $RO_2^{\cdot}$  radical is quite different from the  $R^{\cdot}$  radical. One important difference in chemical activity is that the  $RO_2^{\cdot}$  cannot dimerize. The peroxyradical ( $RO_2^{\cdot}$ ) may be reduced to form a hydroperoxide which is often quite stable.

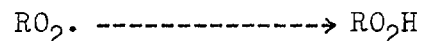

In addition to the chemical changes brought about by ionizing radiations, these radiations also have the capability of altering the physical properties of aqueous colloids. The mechanisms by which these changes are effected, however, are yet unknown.

Some insight into chemical and colloidal changes might be gained by discussing the principal macromolecular changes effected by ionizing radiations. Bacq and Alexander (1961) review three major changes which they class as main chain scission, crosslinking, and disruption of secondary structure.

Main chain scission leads to a molecular weight reduction. It is primarily a process of breaking the long chain of repeating structural components of the macromolecule at random points along its length. This will in effect produce a non-uniform or polydisperse product.



Cross linking is the process by which the macromolecules may form new connecting links within the macromolecule or between macromolecules. Generally as radiation is increased the crosslinking becomes more evident and may produce a gel.

The disruption of secondary structure of the macromolecules is probably exemplified by the action of ionizing radiation on protein. Proteins are normally maintained in a rigid configuration by secondary valence forces. The main chains are held in these rigid configurations by hydrogen bonds. Radiation tends to disrupt these bonds as has been observed with proteins and with DNA.

Some of the more dramatic results of the changes in the macromolecules are discussed by Hollaender and Stapleton (1959). The protein structure of the enzymes seems to be rapidly attacked by radicals and direct radiations. This is of considerable importance especially with the enzymes containing sulfhydryl groups (SH) which seem to be extremely sensitive to radiation. These enzymes are responsible for many of the energy exchange functions in the cytoplasm. Relatively small doses of radiation will significantly reduce their activity. The inactivation seems to result from the oxidation of the sulfhydryl groups which are easy prey to the reactive intermediates liberated by the radiation of water.

The lipid-protein complex of the cell membranes and endoplasmic reticulum are also effected by changes in their structure. This will of course contribute to changes in the permeability the membranes. In addition since these membranes also provide some of the containers for the enzymes and substrates, damage to the structural integrity of these portions will result in a release of enzymes from their normal locations.

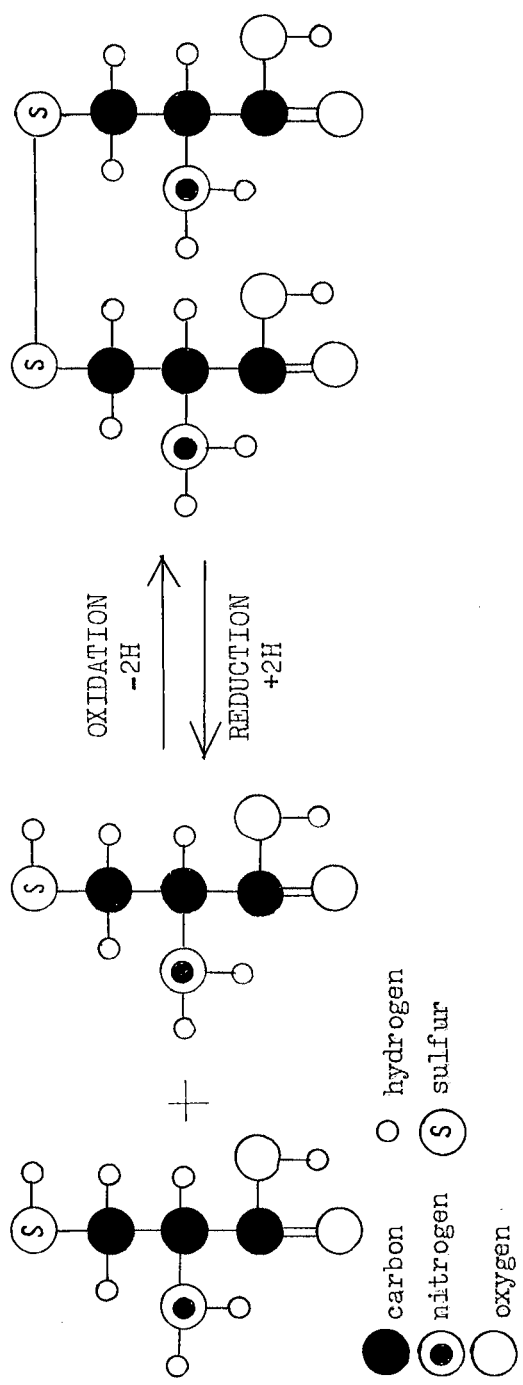
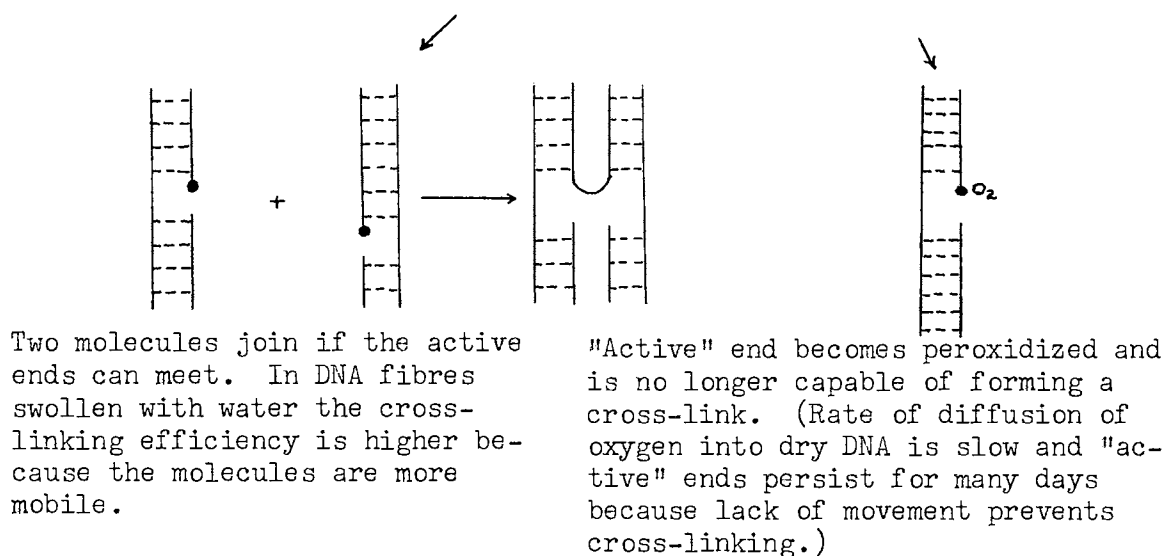
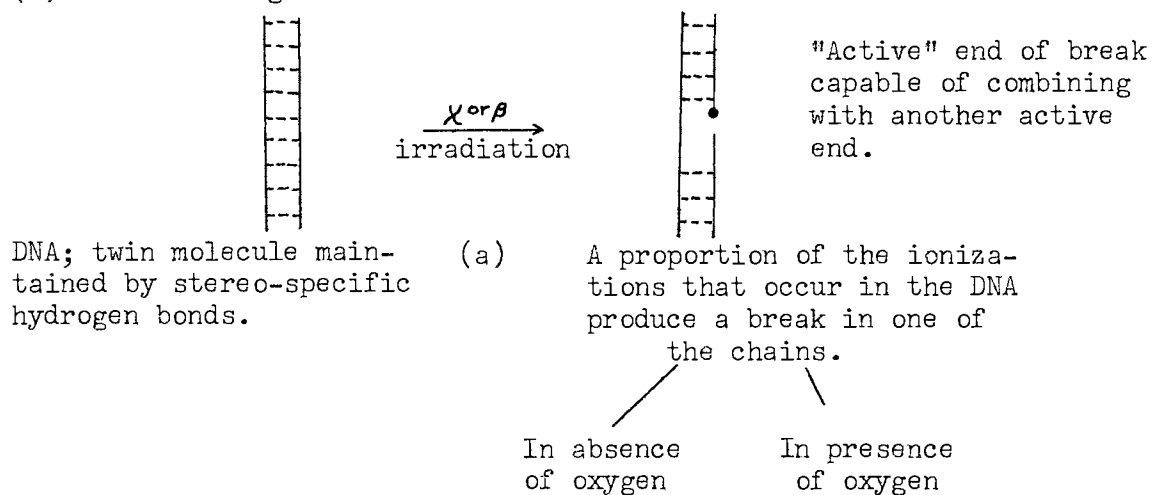

Fig. 3. ENZYMES CONTAINING SULFHYDRYL GROUPS (SH) are especially sensitive to ionizing radiation. Such enzymes are apparently inactivated by the oxidation of sulfhydryl groups in their cysteine amino acid units. At left are two molecules of cysteine. When their sulfhydryl groups are oxidized (lose hydrogen atoms), their sulfur atoms join to form a disulfide bridge in the enzyme. The process is reversed by reduction (adding hydrogen). (Hollaender and Stapleton, 1959)

Thus the released enzymes may traverse the cytoplasm inactivating other enzymes which they encounter.

Of the changes occurring in structure to macromolecules, none can be considered more far-reaching in effect than those occurring in the nuclear protein. Bacq and Alexander (1961) present the observations of molecular changes caused by direct action of radiation on DNA. A diagrammatic representation of this activity as presented by these authors is included herein. Although the diagram is self-explanatory from a standpoint of mechanisms, it should be emphasized that structural changes in these macromolecules may grossly effect the cells which fall heir to this DNA. Since the genetic coding is considered to be located in this material, any structural changes may result in an altered genetic make-up. The end product of such a change may then range from an undetected mutation to lethality. This is significant of course in somatic cells, but takes on added import when it involves the germinal cells.

## (a) Cross-linking



## (b) Main-chain Scission

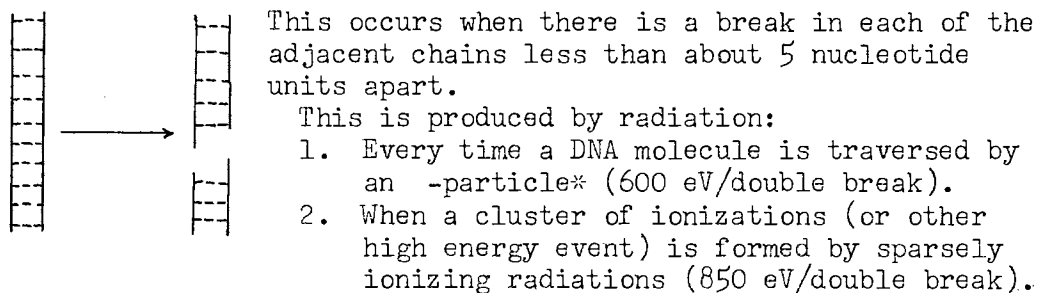

\*Some cross-links are produced at the same time as main-chain scission by  $\alpha$ -rays due to the relatively sparsely ionizing  $\delta$ -rays.

Fig. 4. Changes in the macromolecular properties of DNA brought about by ionizing radiations. (Alexander, 1961)

## CHAPTER IX

### SUMMARY

The preceding pages have been an attempt of the part of the author to condense into a short discussion the mechanisms which are active in the absorption of ionizing radiations into a biological system.

As can easily be discerned by the reader, the great gaps in knowledge of this series of mechanisms lies in the chemical processes relating to the energy absorption by the organic compounds. The macromolecules become exceedingly complex in their structures. Added to the structural complexity is the consideration of their dynamic state of flux within the cell. Therefore it seems that before many of the questions on the mechanisms of radiation damage can be answered, considerably more knowledge will have to be available on the structure and the function of the cellular components and their relationships with one another.

Probably one of the most difficult concepts to grasp is the fact that such a seemingly small amount of energy when absorbed by a living organism can create such change within the system. Platzman (1959) explains this phenomenon in the following manner:

The potency of ionizing radiations in chemistry and in life processes is a consequence of the extreme reactivity of the energy-rich, chemically active molecules. If the energy were merely degraded into heat, instead of augmenting their electronic energy, ionizing radiations would have little significance outside of physics.

An activated molecule may, but need not, lead to a permanent effect. The evolution of the action of radiation,

from the primary exciting or ionizing event to the end product, is the most exciting front now being explored by investigators.

In terminating this discussion, the statement of Hollaender and Stapleton (1959) seems especially well suited to a summation:

The processes of life involve a relatively low turnover of energy and a high degree of selfregulating harmony. In contrast, ionizing radiation conveys huge packets of energy and upon interaction with living matter, provokes anarchy. The consequences may run, in extreme circumstances, to the dearrangement of the hereditary mechanism or to the death of the organism. In every case the ultimate damage arises from the injury done to individual cells. But injury to the cell itself, must be understood in terms of the events that occur in the substance of the cell along the paths of the ionizing ray or particle. Like the ionizations that mark the track of a particle in a cloud chamber, these are discrete and specific events in which particular molecules are involved. The biological outcome thus depends not so much on the amount of energy impinging on the cell as on the energy absorbed by the molecules caught in the track of ionization.

## BIBLIOGRAPHY

- Alexander, Peter. Atomic Radiation And Life. London: Whitefriars Press Ltd., 1959.
- Alexander, Peter. Radiation Protection And Recovery. Ed. Alexander Hollaender. New York: Pergamon Press, 1960.
- Alexander, Peter, and Z. M. Bacq. Fundamentals of Radiobiology. 2nd ed. New York: Pergamon Press, 1961.
- Alper, T. and N. E. Gillies. Immediate and Low Level Effects of Ionizing Radiations. London: Taylor and Francis, 1960.
- Cronkite, E. P., and V. P. Bond. Radiation Injury In Man. Springfield, Illionis: Charles C. Thomas, 1960.
- Dainton, F. S. "Some Aspects of Radiation Chemistry Which Are Relevant to Some Radiobiological Problems." Progress In Radiobiology. Birmingham, England: Kynoch Press, 1955.
- Harris, R. J. C. The Initial Effects of Ionizing Radiations. New York and London: Academic Press, 1961.
- Hollaender, Alexander, and G. E. Stapleton. "Ionizing Radiation and the Living Cell." Scientific American. September, 1960.
- Lapp, Ralph E. and H. L. Andrews. Nuclear Radiation Physics. 3rd ed. Englewood Cliffs, New Jersey: Prentice-Hall, 1963.
- Platzman, R. L. "What Is Ionizing Radiation." Scientific American. September, 1959.
- Schubert, J. and R. E. Lapp. Radiation: What It Is And How It Affects You. New York: Viking, 1957.
- Thompson, John F. Radiation Protection In Mammals. New York: Guinn Co., 1962.

VITA

Gordon Ryan Meyers

Candidate for the Degree of

Master of Science

Report: MECHANISMS INVOLVED IN THE ABSORPTION OF IONIZING RADIATIONS IN  
BIOLOGICAL SYSTEMS

Major Field: Natural Science

Biographical:

Personal Data: Born in Le Roy, Minnesota, February 27, 1932, the  
son of Clarence M. and Edith Rebecca Meyers.

Education: Attended grade school in Le Roy, Minnesota; graduated  
from Le Roy High School in 1950; received the Bachelor of Arts  
degree from State College of Iowa, with a major in science, in  
August 1958; attended graduate school of State College of Iowa  
during the summers of 1959 and 1961; attended graduate school  
of Wayne State University during summer of 1960; completed re-  
quirements for the Master of Science degree at Oklahoma State  
University in May, 1964.

Professional Experience: Entered the teaching profession in August,  
1958 and employed since that time as science instructor and  
science department chairman in the Rochester Public Schools of  
Rochester, Minnesota; presently on leave of absence from this  
position to study under a National Science Foundation Grant.