

ZOOGEOGRAPHY OF OUACHITA HIGHLAND

FISHES

By

MICHAEL R. SCHWEMM

Bachelor of Science in Zoology
Arizona State University
Tempe, Arizona
1998

Master of Science in Biology
Arizona State University
Tempe, Arizona
2006

Submitted to the Faculty of the
Graduate College of the
Oklahoma State University
in partial fulfillment of
the requirements for
the Degree of
DOCTOR OF PHILOSOPHY
December 2013

ZOOGEOGRAPHY OF OUACHITA HIGHLAND
FISHES

Dissertation Approved:

Anthony A. Echelle

Dissertation Adviser

Ronald A. Van Den Bussche

James M. Long

Andrew N. Doust

ACKNOWLEDGEMENTS

I would like to thank my major advisor, A. A. Echelle, for significant encouragement throughout the completion of my dissertation. I consider our many discussions, both formal and as dear friend, the most important contribution to my education. His efforts and patience in my training was invaluable. I also thank my committee members R. A. Van Den Bussche, J. M. Long and A. N. Doust for their time and critical review of this work. I am particularly grateful for R. A. Van Den Bussche for providing an excellent opportunity to conduct laboratory aspects of my research.

I also thank D. T. Lynch for considerable efforts in the field, as well as J. B. Lack and C. Stanley for technical aspects in the laboratory. Additionally, I am especially thankful for J. M. Barkstedt, whose efforts contributed substantially to all aspects of this research and my success at Oklahoma State University.

Additional collections and support were provided by the *Percina pantherina* annual monitoring crew from the U. S. Forest Service and the U.S. Fish and Wildlife Service. These include R. Bastarache, B. Bristow, K. Collins, D. Fenner, and R. Standage, and personnel from the Oklahoma Department of Wildlife Conservation. Funding was provided by the U. S. Forest Service and the Oklahoma Chapter of The Nature Conservancy, and administered by the Oklahoma Cooperative Fish and Wildlife Research Unit and the Department of Zoology at Oklahoma State University.

Name: MICHAEL R. SCHWEMM

Date of Degree: DECEMBER, 2013

Title of Study: ZOOGEOGRAPHY OF OUACHITA HIGHLAND FISHES

Major Field: ZOOLOGY

Abstract: Knowledge about species distributions in space and time is a central goal of comparative phylogeography, and essential to understanding evolution, ultimately providing the mechanisms for the origin and maintenance of biological diversity. The Ouachita Highlands of central North America, together with the Ozark and Eastern Highlands, comprised a once continuous upland region now separated by intervening lowland habitats unsuitable for most highland species. These disjunct upland habitats now support exceptional richness in aquatic taxa. The complex biogeographic history of the Ouachita Highlands provides an excellent opportunity to investigate taxa with distinctive distributional patterns. In this dissertation I use mtDNA and microsatellite variation to assess the phylogeographic history, demographic changes and conservation status of small-bodied fishes of the Ouachita Highlands. The first study examines phylogeographic history of *Notropis suttkusi* (rocky shiner) to infer historical factors governing the composition of the fish assemblage. My second study investigates the impacts of reservoirs on the genetic structure of *Percina pantherina* (leopard darter), a federally threatened species of the Little River system. My third study examines how intrinsic life-history attributes mediate patterns of genetic variation and gene flow in two syntopic darters, *P. pantherina* and *P. caprodes* (logperch). Last, my final two chapters are methodological notes describing the development of microsatellite markers used to conduct the above investigations.

TABLE OF CONTENTS

Chapter	Page
I. INTRODUCTION.....	1
References.....	4
II. HISTORICAL DEMOGRAPHY AND PHYLOGEOGRAPHY OF THE ROCKY SHINER: DO EXTIRPATIONS EXPLAIN PATTERN OF OCCURRENCE OF OZARK FISHES IN THE RED RIVER, OKLAHOMA, USA?	8
Introduction.....	10
Materials and Methods.....	13
Results.....	18
Discussion.....	22
References.....	26
Tables.....	34
Figures.....	38
Appendices.....	44
III. GENETICALLY EFFECTIVE POPULATION SIZES AND ANTHROPOGENIC RANGE FRAGMENTATION IN THE THREATENED LEOPARD DARTER: THE ROLE OF LARGE-RESERVOIR CONSTRUCTION	53
Introduction.....	54
Materials and Methods.....	56
Results.....	61
Discussion.....	64
References.....	69
Tables.....	77
Figures.....	84
Appendices.....	88

Chapter	Page
IV. LIFE-HISTORY DIFFERENCES PREDICT PATTERNS OF GENETIC VARIATION IN TWO CO-OCCURRING DARTERS, <i>PERCINA PANTHERINA</i> AND <i>P. CAPRODES</i>	92
Introduction.....	93
Materials and Methods.....	94
Results.....	96
Discussion.....	98
References.....	101
Tables.....	107
Figures.....	112
Appendices.....	115
V. ISOLATION AND CHARACTERIZATION OF 10 POLYMORPHIC MICROSATELLITE MARKERS FOR THE OUACHITA HIGHLANDS ENDEMIC <i>NOTROPIS SUTTKUSI</i> (TELEOSTEI: CYPRINIDAE)	116
Results.....	117
References.....	119
Tables.....	120
VI. DEVELOPMENT AND CHARACTERIZATION OF EIGHT POLYMORPHIC TETRA-NUCLEOTIDE MICROSATELLITE MARKERS FOR THE THREATENED LEOPARD DARTER (<i>PERCINA PANTHERINA</i>).....	122
Results.....	123
References.....	125
Tables.....	128

CHAPTER I

INTRODUCTION

Knowledge about species distributions in space and time is a central goal of comparative phylogeographic study. Such insights are essential to understanding evolution, ultimately revealing the mechanisms for the origin and maintenance of biological diversity. A multi-species comparison of genetic variation permits investigation of specific hypotheses of how geologic and climatic forces influence patterns of genetic variation in co-distributed taxa (Avice 2000). Often, such concordance yields replicate patterns among species and implicates the role of historical biogeographic factors that simultaneously influence multiple taxa (Avice 1992, 2009). However, the expectation of congruent patterns across diverse taxa has shifted to allow independence due to differences in evolutionary response to vicariant events (Sullivan 2000, Carstens et al. 2005, Steele and Storfer 2007). Another cause of genetic incongruence among co-distributed species include differences in life-history traits affecting levels of gene flow (McDonald et al. 1999, Turner et al. 1996; Harris et al. 2012) and genetic effective population size (Turner et al. 2006).

Understanding patterns of genetic diversity across landscapes and the processes maintaining such diversity is also crucial for informed conservation management decisions (Echelle 1991; Avise 1992, 2000). The comparative approach maintains advantages over single-species considerations in informing conservation decisions because pertinent traits (e.g., geographic scale of gene flow) may vary considerably among species (Whiteley et al. 2006, Blanchet et al. 2010). At present, many aquatic ecosystems are in serious jeopardy. Estimates of imperiled fishes from North America range from 27% to 34% of all species (Helfman 2007). Extinction rates for freshwater animals are up to four percent per decade (Dudgeon et al. 2006). Key factors driving such declines include introductions of non-native fishes and alteration of flow regimes by damming, channelization, and overmining of groundwater (Minckley et al. 1991; Poff et al 2006).

The Ouachita Highlands, together with the Ozark Plateau, comprise the Interior Highlands province of central North America. The Ouachita Highlands harbor considerable species richness in aquatic taxa (Mayden 1985, 1988; Cross et al. 1986, Matthews and Robison 1982). Geologic history and species assemblages suggest that, prior to the Pleistocene, the Interior Highlands was a continuous uplifted region with a distinctive aquatic fauna of upland species (Cross et al. 1986; Taylor et al. 2004; Bonett and Chippindale 2004). Vicariance separating the Ozark and Ouachita aquatic faunas occurred during headward downcutting of the lower Arkansas River sometime prior to the last (Sangamon) interglacial period (Thornbury 1965; Mayden 1985), which began about 125 kya. This formed the present Arkansas River and associated lowlands that separate the upland aquatic fauna of the Interior

Highlands into Ozark and Ouachita highland components (Mayden 1985; Miller and Robison 2004; Robison 1986).

The biogeographic history of the Ouachita Highlands provide an excellent opportunity to investigate taxa with distinctive distributional patterns. The fish fauna of the region includes endemic species, some species shared with the Ozarks, and others widespread in central and eastern North America (Cross et al. 1986). Among the Ouachita Highlands endemics, some occur in most tributaries across the region, but others are restricted a few or even single streams (Miller and Robison 2004). Additionally, most of the tributary streams are impacted by anthropogenic modifications that threaten various components of the fish fauna, especially species restricted to upland stream habitats. These factions include large-reservoir dams, agriculture, and silviculture (James et al. 1991).

In this dissertation, I use mtDNA and microsatellite variation to assess the phylogeographic history, demographic changes and conservation status of small-bodied fishes of the Ouachita Highlands of central North America. The first study (Chapter II) is a detailed examination of the phylogeographic history of *Notropis suttkusi* (rocky shiner), an abundant endemic of south-flowing tributaries of the Red River (Humphries and Cashner 1994). Its abundance and distribution in upland habitats make this species well suited to infer historical factors governing the composition of the fish assemblage in the Ouachita Highlands. My second study (Chapter III) investigates the impacts of reservoirs on the genetic structure of *Percina pantherina* (leopard darter), a federally threatened species of the Little River system. In

contrast to chapters II and III, which focus on extrinsic factors (i.e., natural and anthropogenic factors affecting genetic structure), my third study (Chapter IV) examines how intrinsic life-history attributes mediate patterns of genetic variation and gene flow. Here, I compared two sympatric species, *Percina pantherina* and *P. caprodes* (logperch), with life-history differences expected to influence genetic structure. My final two chapters (V and VI) are methodological notes describing the development of the microsatellite markers used in chapters II and III.

References

- Tamura K, Peterson D, Peterson N, Stecher G, Nei M, Kumar S (2011) MEGA5: molecular evolutionary genetics analysis using maximum likelihood, evolutionary distance, and maximum parsimony methods. *Molecular biology and evolution* 28 2731-2739
- Avise JC (1992) Molecular population structure and the biogeographic history of a regional fauna: a case history with lessons for conservation biology. *Oikos* 63, 62-76
- Avise JC (2000) *Phylogeography: the history and formation of species*. Sinauer Associates, Sunderland
- Avise JC (2009) Phylogeography: retrospect and prospect. *Journal of Biogeography* 36, 3-15.
- Blanchet S, Rey O, Etienne R, Lek S, Loot G (2010) Species-specific responses to landscape fragmentation: implications for management strategies. *Evolutionary Applications* 3, 291-304

- Bonett RM, Chippindale PT (2004) Speciation, phylogeography and evolution of life history and morphology in plethodontid salamanders of the *Eurycea multiplicata* complex. In: *Molecular Ecology*, Blackwell Publishing Limited, pp. 1189-1203
- Carstens BC, Brunsfeld SJ, Demboski JR, Good JM, Sullivan J (2005) Investigating the evolutionary history of the Pacific Northwest mesic forest ecosystem: Hypothesis testing within a comparative phylogeographic framework. *Evolution* 59, 1639-1652
- Cross FF, Mayden RL, Stewart JD (1986) Fishes in the Western Mississippi Drainage. In: Hocutt CH, Wiley EO (eds) *The Zoogeography of North American freshwater fishes*. John Wiley and Sons, New York, pp363-412
- Dudgeon D, Arthington AH, Gessner MO, Kawabata ZI, Knowler DJ, Leveque C, Naiman RJ, Prieur-Richard AH, Soto D, Stiassny MLJ, Sullivan CA (2006) Freshwater biodiversity: importance, threats, status and conservation challenges. *Biological Reviews* 81, 163-182
- Echelle AA (1991) Conservation Genetics and Genic Diversity in Freshwater Fishes of Western North America. In: Minckley WL DJE (ed) *Battle against extinction: native fish management in the American West*. University of Arizona Press, Tucson, pp141-154
- Harris L, Taylor E, Tallman R, Reist J (2012) Gene flow and effective population size in two life-history types of broad whitefish *Coregonus nasus* from the Canadian Arctic. *Journal of Fish Biology* 81, 288-307
- Helfman G (2007) *Fish conservation :a guide to understanding and restoring global aquatic biodiversity and fishery resources*. Island Press, Washington

- James PW, Maughan OE, Zale AV (1991) Life-history of the leopard darter *Percina pantherina* in Glover River, Oklahoma. *American Midland Naturalist* 125, 173-179
- Matthews WJ, Robison HW (1982) Addition of *Etheostoma collettei* (Percidae) to the fish fauna of Oklahoma and of the Red River drainage in Arkansas. *Southwestern Naturalist* 27, 215-216
- Mayden RL (1985) Biogeography of Ouachita Highland fishes. *Southwestern Naturalist* 30, 195-211
- Mayden RL (1988) Vicariance biogeography, parsimony, and evolution in North-American fresh-water fishes. *Systematic Zoology* 37, 329-355
- McDonald DB, Potts WK, Fitzpatrick JW, Woolfenden GE (1999) Contrasting genetic structures in sister species of North American scrub-jays. *Proceedings of the Royal Society of London Series B: Biological Sciences*, 266, 1117-1125.
- Miller RJ, Robison HW (2004) *Fishes of Oklahoma*. University of Oklahoma Press, Norman
- Minckley WL, Deacon JE (1991) *Battle against extinction: native fish management in the American West*, University of Arizona Press, Tucson
- Poff NL, Olden JD, Vieira NKM, Finn DS, Simmons MP, Kondratieff BC (2006) Functional trait niches of North American lotic insects: traits-based ecological applications in light of phylogenetic relationships. *Journal of the North American Benthological Society* 25, 730-755
- Robison HW (1986) Zoogeographic implications of the Mississippi River basin. In: Hocutt CH, Wiley EO (eds) *The Zoogeography of North American freshwater fishes*. John Wiley and Sons, New York, pp267-286

- Steele CA, Storfer A (2007) Phylogeographic incongruence of codistributed amphibian species based on small differences in geographic distribution. *Molecular Phylogenetics and Evolution* 43, 468-479
- Sullivan J, Arellano E, Rogers DS (2000) Comparative phylogeography of Mesoamerican highland rodents: concerted versus independent response to past climatic fluctuations. *The American Naturalist* 155, 755-768
- Taylor CA, Jones SN, Bergey EA (2004) Crayfishes of Oklahoma revisited: new state records and checklist of species. *Southwestern Naturalist* 49, 250-255
- Thornbury WD (1965) Regional geomorphology of the United States. John Wiley and Sons, New York
- Turner TF, Robison HW (2006) Genetic diversity of the caddo madtom, *Noturus taylori*, with comments on factors that promote genetic divergence in fishes endemic to the Ouachita Highlands. *Southwestern Naturalist* 51, 338-345
- Turner TF, Trexler JC, Kuhn DN, Robison HW (1996) Life-history variation and comparative phylogeography of darters (Pisces: Percidae) from the North American central highlands. *Evolution* 50, 2023-2036
- Whiteley AR, Spruell P, Allendorf FW (2006) Can common species provide valuable information for conservation? *Molecular Ecology* 15, 2767-2786

CHAPTER II

HISTORICAL DEMOGRAPHY AND PHYLOGEOGRAPHY OF THE ROCKY SHINER: DO EXTIRPATIONS EXPLAIN PATTERN OF OCCURRENCE OF OZARK FISHES IN THE RED RIVER, OKLAHOMA, USA?

Extirpation of species is a widely recognized factor in the evolution of contemporary stream faunas, but the mechanism of extirpation has rarely been explicitly evaluated beyond assuming some kind of area effect or related factor, such as habitat diversity. In this paper, I evaluate the role of extirpation in explaining differences among fish faunas in upland streams of the Ouachita Highlands in southcentral Oklahoma, USA. The upper reaches of these streams support several species representing disjunct populations of species most commonly associated with the Ozarks. In particular, I focus on the observation that Blue River supports four such populations, whereas other Red River tributaries in the Ouachita Highlands of Oklahoma support only one or two or none of these species. This might reflect greater environmental stability in Blue River through evolutionary time. The prediction is that Ouachita Highlands endemics with wide distributions will show molecular signals of fluctuations in population size that are not seen in Blue River. To test this, I assayed mtDNA (*cytb*) and 10 microsatellite loci from populations encompassing the entire range of the small cyprinid *Notropis suttkusi*, a

widespread endemic of the Ouachita Highlands. The results indicate stability for the Blue River population, whereas other populations show evidence of late Pleistocene (Wisconsin) expansion and a Holocene decline in effective population sizes. Population stability in Blue River likely reflects the fact that the upper reach of the river is the largest springfed environment in southern Oklahoma. Geographic structure in *N. suttkusi* is weak with only 1.2 and 14.3% of genetic diversity in, respectively, microsatellites and mtDNA associated with differences among populations. The low level of divergence is attributed to relatively recent (Holocene) fragmentation of the range and transfers across drainage divides.

Introduction

A tenet of biogeography is that harsh abiotic environments support fewer species than benign environments (Brown and Lomolino 1998). Abiotic harshness can be defined in two ways, one based on stress imposed by physicochemical variables, and one based on factors affecting the potential for demographic extirpation and recolonization, for example amount of living space and degree of isolation (Brown and Lomolino 1998). All else being equal, small, isolated living space is harsh because populations are smaller, more susceptible to demographic extirpation, and re-colonization is less likely. A corollary is that harshness fluctuates in evolutionary time, with greater chances of extirpation during times of reduced living space. For example, the shrinking size and increasing isolation of many bodies of water during late Cenozoic desertification in western North America contributed to the low diversity of fishes in the region (Smith 1981). Similarly, smaller, unglaciated upland areas of North America have lower fish diversity than larger upland areas (Mayden 1988), presumably because of isolation and the effect of habitat size on demographic extirpation, not as a result of stress imposed by the habitat.

For many fishes, upland streams are isolated islands of suitable conditions separated by unfavorable downstream habitats. Consequently, the Central Highlands of North America support the highest diversity of freshwater fishes on the continent, with many species endemic to relatively small watersheds (Cross et al. 1986; Hocutt et al. 1986; Mayden 1988). Phylogeographic studies demonstrate that Quaternary dispersal between the Eastern Highlands (east of the Mississippi River) and the Interior Highlands (Ozark and Ouachita uplifts) and in situ diversification both are important contributors to aquatic biodiversity of the Central Highlands (Strange and Burr 1997; Crandall and

Templeton 1999; Near and Keck, 2006). However, there has been no explicit assessment of the role of extirpation as a contributor to fish assemblage structure among highland streams.

Extirpations should contribute significantly to the composition of highland fish assemblages in highland streams. Extirpations are suggested by post-Pleistocene distributions of a variety of fishes that would have been more widespread during cooler periods of the Pleistocene and now show disjunct patterns with a northern distribution in the Upper Midwest and a more southerly distribution in the Ozarks (Burr 1978; Burr and Page 1986). Also, extirpations of highland fishes have been inferred to reconcile conflicts between observed distributions of individual species and expectations from consensus area-cladograms based on multispecies occurrences (Mayden 1988). Although extirpations are often mentioned, mechanisms generally are not assessed except at the scale of local variation in species richness in ecological time (Matthews et al. 1994; Taylor 1997) or assumptions of relative extirpation rates based on area effects or related factors such as habitat structure (Angermeir and Schlosser 1989; Matthews and Robison 1998).

In this paper I assess the possibility that habitat stability through evolutionary time has played a role in assemblage composition of fishes in upland reaches of the Red River system in southern Oklahoma. My focus is on a long-recognized biogeographic feature, the presence in Blue River of persistent populations or several components of Ozark fauna (Lachner and Jenkins 1971; Burr 1978; Mayden 1985): *Phoxinus erythrogaster* (southern redbelly dace), *Nocomis asper* (redspot chub), *Etheostoma microperca* (least darter), and *Percina fulvitaenia* (Ozark logperch). Other Red River

tributaries support only one or two of these four species, if any. My hypothesis is that conditions in Blue River have been more stable through evolutionary time. The assumption is that Blue River and nearby upland streams had the same historical access to the regional fauna. A prediction is that the historical demography of wide-ranging upland species in the region will show genetic signals consistent with greater stability in Blue River than in other streams.

The species chosen for this analysis is a small cyprinid, the rocky shiner, *Notropis suttkusi*, endemic to upland reaches of south-flowing Red River tributaries from the Little River in southeastern Oklahoma westward to Blue River in southcentral Oklahoma. The sister species is an undescribed form in the Ouachita River of Arkansas, *N. cf. percobromus* (Berendzen et al. 2008). The two species might have had a common ancestor in Mayden's (1985) Pre-glacial Ouachita River, a hypothetical system extending from the Ouachita River west to the headwaters of the present Blue River and connecting upland portions of what now are tributaries of Red River. Later, the modern Red River developed by headward erosion, capturing portions of the Pre-glacial Ouachita River and, farther west, portions of Metcalf's (1966) preglacial Plains Stream, a hypothetical system that extended from Kansas to the Gulf of Mexico (Mayden 1985; Cross et al. 1986).

The Pre-glacial Ouachita River hypothesis arose to explain the present occurrence of upland fishes isolated in separate tributaries of the Red River by inhospitable downstream reaches of the system (Mayden 1985). Isolation of ancestral *N. suttkusi* from *N. cf. percobromus* is estimated to have occurred about 3 Ma b.p. (Berendzen et al. 2008), possibly as an early result of the capture of western portions of the Pre-glacial Ouachita River by the headward eroding Red River. Based on this timing and evidence of

restricted gene flow among upland fishes in the Red River system (Moore and Rigney 1952; Echelle et al. 1975), I expected to find marked phylogeographic breaks among populations of *N. suttkusi* in different tributaries of the system.

Materials and Methods

Sampling and DNA isolation—I collected *N. suttkusi* from six sites during summer 2009, one in each of the major rivers supporting the species (Fig. 1; locality abbreviations in parentheses): 1) Blue River (BR) 34°27' 16.07" N, 96° 38' 6.46" W; 2) Clear Boggy Creek (CB) 34° 18' 32.51" N, 96° 16' 47.74" W; 3) McGee Creek tributary of Muddy Boggy Creek (MB) 34° 18' 36.54" N, 101° 52' 35.24" W; 4) Kiamichi River (KR) 34° 26' 50.88"N, 95° 33' 44.47" W; 5) Little River (5) 34° 19' 31.60" N, 95°11'57.63" W; and 6) Glover River (GR) 34° 5' 50.55" N, 94° 54' 9.80" W. Forty individuals from each site were preserved in 95% ethanol in the field. The DNeasy® blood and tissue kit (Qiagen, Valencia, CA) was used to extract DNA from a portion of the caudal fin (~5 x 5 mm) of each specimen.

Molecular markers—Mitochondrial sequence diversity was assessed using the complete cytochrome *b* (*cytb*) gene (1140 bp). Sequences were amplified and sequenced in both directions using PCR primers LA (5'-GTGACTTGAAAAACCACCGTT-3') and HA (5'-CAACGATCTCCGGTTTACAAGAC-3') (Schimdt et al. 1998). Amplification was done in 25- μ L PCR reactions: 0.125- μ L (5 U/ μ L) Promega GoTaq ® Flexi DNA polymerase (Madison, Wisconsin); 5- μ L (5X) Promega PCR buffer; 2.5- μ L (25 mM) MgCl₂; 1.25- μ L (0.5 μ M) each, forward and reverse primers; 0.2- μ L (25mM) dNTPs;

13.7 μL ddH₂O; 1- μL (1-4 ng) DNA. The thermal profile used in both reactions included 35 cycles of 94°C, 30 s; 53°C, 30 s; 72°C, 90 s; plus an initial denaturing of 94°C at 60 s and final extension of 7 m at 72°C. The products were cleaned for sequencing with either the Wizard SV PCR cleanup kit (Promega, Madison, Wisconsin) or EXOSAP (USB Corp., Cleveland, Ohio) with a modified temperature profile of 37° C for 30 min, 80° C for 15 min and 12° C for 5 min. I used the amplification primers in sequencing reactions and resolved the sequences with an ABI model 3130 sequencer (Applied Biosystems, Foster City, California). I used Geneious ver. 5.6.4 for manual sequence editing and alignment (Biomatters Ltd., New Zealand).

Microsatellite variation was characterized with 10 tetra-nucleotide loci (A1, A4, A103, B9, B106, C109, D3, D102, D108 and D111) developed for this species (Schwemm et al., *in press*). The following PCR parameters were used for all loci: 95°C for 12 min, 35 cycles of 94°C for 40 s, 57°C for 40 s, 72°C for 30 s, and 72°C for 4 min. The reaction mix (15 μL total volume) contained 1-3 ng of template DNA in 1 μL ddH₂O, 0.5 μL of each primer (10 μM), 4 μL ddH₂O, and 9 μL True Allele PCR mix (Applied Biosystems, Inc.). Capillary electrophoresis using an ABI 3130 Genetic Analyzer was performed on solutions containing the combined post-amplification reaction mixes from 2-3 loci (0.5 μL each locus), 0.5 μL 400HD ROX size standard (Applied Biosystems, Inc.), and 9 μL formamide (Applied Biosystems, Inc.). Length variants were visualized and genotyped using GeneMarker 1.91 (SoftGenetics LLC, State College, Pennsylvania, USA). Errors in genotyping were evaluated by rescoring 5% of individuals.

Data Assumptions—I tested nuclear microsatellite loci for deviations from Hardy-Weinberg expectations (HWE) and gametic disequilibrium using exact tests in GENEPOP 4.2 (Raymond and Rousset 2004; Rousset 2008) with the Markov-chain approach and 5000 dememorizations, 500 batches, and 5000 iterations. (Guo and Thompson 1992). Significance was determined by sequential Bonferroni correction for $\alpha = 0.05$ (Rice 1989). I assessed the presence of null alleles using MICRO-CHECKER (van Oosterhout et al. 2004). For *cytb*, I evaluated the potential impact of selection by assessing the number of synonymous and non-synonymous substitutions.

Variation within populations—Microsatellite variation within populations was summarized for number of alleles and allelic richness (A_R) using FSTAT v. 2.9.3.2 (Goudet 1995), and private alleles (A_P) adjusted by rarefaction using HP-RARE (Kalinowski 2005). Observed and expected heterozygosities were calculated in GENEPOP 4.2 and significance Bonferroni adjusted for number of tests.

For *cytb*, I used HAPLOTYPE ANALYSIS 1.04 (Eliades and Eliades 2009) to compute number of haplotypes and haplotype richness, and I used ARLEQUIN v. 3.5.1.3 (Excoffier and Lischer 2010) to compute gene diversity (h ; Nei 1987) and nucleotide diversity (π ; Tajima 1993). I used the median-joining method in NETWORK 4.5.1.6 (Bandelt et al. 1999) to obtain a haplotype network. Ambiguities in the network (loops) were few, and resolved by joining haplotypes through the most common haplotype and preferring transitions to transversions.

Historical population demography was assessed from mtDNA in three ways. First, I used ARLEQUIN, to assess past change in population size by computing Tajima's D

(Tajima 1989a, 1989b) and Fu's F_S (Fu 1997) to test the hypothesis, under a neutral Fisher-Wright model, that population size has been constant. Second, demographic history was assessed using mismatch distributions (Rodgers and Harpending 1992), the frequency histograms of pairwise nucleotide differences among haplotypes in a population. The distribution is typically multimodal for populations at demographic equilibrium and unimodal in populations that have experienced demographic expansion or range expansion (Rodgers and Harpending 1992, Excoffier 2005). The mode of pairwise differences between sequences (τ) was used to estimate the population parameter $\tau = 2ut$ in ARLEQUIN (Rogers and Harpending 1992, Excoffier and Lischer 2010), where u is mutation rate for the sequence and t is time in generations following a population expansion event. The parameter τ is time (generations) in mutation units since expansion. To convert to time in years, I used a generation time of one year and the divergence rate ($2.0 \pm 0.2\%$ per million yrs) previously applied to *cytb* in the *N. percobromus* species group, which includes *N. suttkusi* (Berendzen et al. 2008). In the absence of a cyprinid fossil record for calibration of divergence rate, Berendzen et al. (2008) used the fossil-calibrated rate estimated by Near and Bernard (2004) from concatenated *cytb*-ND2 sequences in logperches (Percidae: *Percina*).

Finally, I estimated long-term change in female effective population size using skyline plots in BEAST 1.5.4 (Drummond and Rambaut 2007). Skyline plots use a Bayesian coalescence approach without a pre-specified parametric model of demographic history (Drummond et al. 2005). Individuals were pooled across populations exhibiting signatures of demographic expansion in mismatch distributions and neutrality tests. I used a coalescent tree prior and a molecular clock enforced with a uniform prior of 2%

per million yrs as above. The MCMC parameters of each analysis included 10,000,000 iterations sampled every 10,000. The model of nucleotide substitution was GTR+I+ Γ ($I = 0.31$, $\Gamma = 0.36$), as selected by AICc in MEGA 5.2 (Tamura et al. 2011).

Variation among populations—Geographic structure was evaluated using a hierarchical analysis of molecular variance (AMOVA) in ARLEQUIN for both microsatellite and mtDNA (Excoffier and Lischer 2010) with tests of significance calculated from 10,000 permutations. Pairwise tests of F_{ST} (microsatellites) and Φ_{ST} (mtDNA) were also performed in ARLEQUIN with 10,000 permutations. To facilitate comparisons between markers with different modes of inheritance (Buonaccorsi et al. 2001) and account for sometimes spurious behavior of F_{ST} for hypervariable markers (Hedrick 2005), I used Jost D (Jost 2008) to calculate actual pairwise divergence (D) among populations. Jost's D is an unbiased analog of F_{ST} that increases linearly with population divergence. Significance of pairwise values were estimated using the permutation approach in the R package DEMETics (R Development Core Team 2009, Gerlach et al. 2010). To test for isolation by distance, I used Mantel tests (Mantel 1967) in R to assess correlation between D matrices and two types of geographic distance matrices, straight-line and stream kilometers separating sites. Straight-line distances were assumed to reflect isolation by distance via headwaters.

With microsatellites, I used STRUCTURE 2.3.4 (Pritchard et al. 2000, Hubisz et al. 2009, <http://prich.bsd.uchicago.edu/structure.html>) with the population sampling information (LOCPRIOR option) to assist clustering of individuals into k groups (Hubisz et al. 2009). When populations are only recently diverged and structuring relatively weak,

LOCPRIOR incorporates the probability that most individuals sampled from a specific locality likely cluster genetically. This option (STRUCTURE 2.3.4) improves the ability to cluster individuals of recent ancestry without bias (Hubisz et al. 2009). With the admixture model and assuming uncorrelated allele frequencies across groups, I estimated Bayesian posterior probabilities for $k = 1$ to 6 by performing four independent runs for each k -value (150,000 iterations, first 50,000 = burn-in). I used STRUCTURE HARVESTER (Earl et al. 2012) to combine replicate runs and calculate ΔK (Evanno et al. 2005) between prospective clustering arrangements, revealing the model (k) most likely to explain the data. Replicate runs for the most likely number of groups were subsequently combined using the software CLUMPP (Jakobsson and Rosenberg 2007) and visualized using DISTRUCT (Rosenburg 2004).

Finally, I evaluated the possibility of ongoing migration among populations using the test for migrants algorithm (MIGRPRIOR option; STRUCTURE 2.3.4). This assumes that sampling locations correspond almost exactly to genetic clusters and requires a strong signal before an individual is classified as a recent migrant or hybrid (Prichard 2000).

Results

Mitochondrial DNA—I detected 67 haplotypes from the 211 *N. suttkusi* sequenced for *cytb* (Fig. 2; Appendix A). There were no fixed differences among the six populations examined. Divergence among haplotypes was low with a mean of 4.00 substitutions (0.35% divergence; range = 1-19). There were 83 variable sites, with 81% (67) synonymous and 19% (16) nonsynonymous substitutions.

Two haplotypes (C and E) were widespread (Fig. 2; Appendix A). Both were common in BR, and present at low levels in KR; otherwise haplotype C occurred only in the west populations (CB, MB) and haplotype E only in the east (LR, and GR). Blue River had relatively few haplotypes (7), whereas the other populations had 13 to 25, all of which were relatively uncommon (Table 1; Fig. 2; Appendix A).

Genetic variation within populations—Indices of mtDNA diversity were lowest for MB, which was nearly fixed for the widespread haplotype C (Fig. 2). Among the remaining populations, haplotype richness, haplotype diversity, and nucleotide diversity were markedly lower for Blue River (Table 1), reflecting the large numbers of haplotypes in the other populations (Fig. 2). In the latter populations, haplotype diversity ranged from 0.89 to 0.97 due to the presence of numerous private haplotypes. Additionally, the transition to transversion ratio varied markedly from 8:3 in BR and 26:1, 38:0 and 46:1 in, respectively, GR, KR and LR. Only 6 substitutions were present among the three haplotypes in MB (Ts:Tv = 6:0).

For microsatellites, significant HWE deviation occurred only in a single population at one locus (GR; locus *C109*) and there was no evidence of linkage disequilibrium or scoring discrepancies. All loci were polymorphic in all populations, and the mean number of alleles for individual loci across populations ranged from 3.5 to 25.0. The loci used were chosen at random based on ease of scoring, independently of level of polymorphism. Six of 10 loci showed greater than nine alleles per population. Measures of microsatellite diversity did not differ appreciably across populations (Table 2).

Variation among populations—For both mtDNA and microsatellites, variation occurred primarily within populations, although a significant, albeit small, percentage was explained by among-population differences for both mtDNA (14.3%, $P < 0.001$) and microsatellites (1.2%; $P < 0.001$). For mtDNA, all pairwise D and Φ_{ST} values were significant, except in two instances (Jost D for LR-GR and Φ_{ST} for KR-LR; Table 3). Microsatellite loci showed much weaker levels of divergence in all comparisons, but particularly among the four eastern-most populations (MB, KR, LR, and GR), which showed only one instance of statistical significance (Jost D for KR-GR).

The tests for isolation by distance (Jost D versus straight-line distances and stream distances) were not significant for either mtDNA ($P = 0.10 - 0.12$) or microsatellites ($P = 0.11 - 0.28$). There was, however, some tendency for eastern (KR, LR, GR) and western (BR, CB) populations to group as two separate clusters for both types of marker (Fig. 3), with the MB collection being the only source of discrepancy. For microsatellites MB grouped with KR, whereas for mtDNA it grouped with BR, reflecting its near fixation for haplotype C, which is more common in BR than in the remaining populations. The Structure analysis of microsatellites gives yet another perspective on groupings. The Evanno et al. (2005) method selected $K = 4$ as the number of populations represented. With $K = 4$, the resulting plot of q -values for each individual (likelihoods of belonging to each of the four populations) shows the following groups: (1) BR, (2) CB, (3) MB-KR, and (4) LR-GR (Fig. 4). The microsatellite-based STRUCTURE test for migrants and recent hybrids among the six collection sites showed no evidence of ongoing gene flow, with every individual classified according to site of collection.

Historical Demography—All populations except BR had significant negative values for Fu's F_S or Tajima's D or both (Table 4), indicating population expansions. In contrast, neither index was significantly different from zero for BR, failing to falsify the hypothesis of constant population size. These results were consistent with the mismatch distributions, which, except for BR, did not deviate significantly from unimodality (Fig. 5; Table 4). The distribution for BR showed a significant raggedness index ($r = 0.25$; $P = 0.02$), as expected from constant population size (Rogers and Harpending 1994), and the sum of squared deviations from the model of expansion was marginally significant ($P = 0.07$). The other populations did not approach significance for these two indexes ($P = 0.31$ - 0.59).

The mean of the modes (τ) for the mismatch distributions among the populations showing evidence of expansion (CB, KR, LR, and GR) was used in estimating time since expansion. If unimodal distributions result from expansion, τ is equal to mutation-scaled time in generations ($\tau = 2\mu t$, Rodgers and Harpending 1994). With the mean $\tau = 4.9$ for the four populations, an evolutionary rate of 0.90–1.10% per lineage (Berendzen et al. 2008), and a generation time of one year, the estimated time since expansion is 213,000 (194,000–236,000) years b.p. The Bayesian skyline plots provide a Bayesian perspective on population expansion. Results from pooling the four populations showing mismatch-distribution signals of expansion indicated that female effective size began increasing about 200,000 years B.P., with a marked increase during the last glacial interval (Fig. 6). The lower bound of the 95% credibility interval did not exceed the upper bound of earlier times until about 50,000 years b.p., which was preceded by an abrupt expansion that

began about 70,000 years b.p. In addition, the plot suggests a possible late Pleistocene-Holocene decline.

Discussion

Several lines of evidence from the genetic structure of *N. suttkusi* are consistent with the hypothesis that Blue River has been more stable through evolutionary time than other Ouachita Highlands streams, offering an explanation of the relatively high representation of Ozark fishes in Blue River: (1) The mtDNA mismatch distributions showed signals of population expansion in all populations except Blue River, (2) The Bayesian skyline plot for those populations identified expansion starting at about the same mutation-scaled time period indicated by the mismatch distributions, and (3) The transition to transversion ratio in Blue River is 10 to 17 times lower than in the other streams. Transitions are considerably more likely than transversions (Lanavae et al. 1986) and are expected to be more common in expanding populations than in stable populations at mutation-drift equilibrium. Finally (4), the *F_s* and *D* tests of neutrality (i.e., genetic structure reflects mutation-drift equilibrium) was not falsified for Blue River, but all other populations showed significant deviation, with negative values for one or both statistics. Negative values can reflect either natural selection or population expansion, but the former is unlikely here because 81% of the substitutions were synonymous and not subject to selection.

The expansion of *N. suttkusi* in Red River tributaries exclusive of upper Blue River appear to have occurred in the late Pleistocene, based on the mtDNA analyses. The coalescence-based Bayesian skyline plot (BSP) and the computation based on the

mismatch distributions both indicate expansion beginning about 200,000 years b.p. However, the lower bound of the 95% credibility interval in the BSP did not surpass the earlier upper bound until about 50 thousand years ago. This followed a pronounced increase that began early in the Wisconsin glacial interval about 75 thousand years b.p.

The indicated Wisconsin glacial increase in size for most populations of *N. suttkusi* is consistent with Burr's (1978) hypothesis for southern populations of cool-water fishes, such as disjunct Ozark populations in the Red River. He suggested that such fishes were more widely dispersed during cooler periods of the Pleistocene and that during warm intervals they contracted into upland, spring-fed habitats with relatively cool summertime temperatures. The detected change in sizes of the remaining populations could reflect either late Pleistocene colonization (for example, from Blue River) and an associated expansion or in situ population decline and expansion. An interesting pattern from the mtDNA haplotype network is the central (ancestral) position of a relatively uncommon haplotype detected only in the Kiamichi River. This haplotype (PP) is one substitution removed from both of the two most widely distributed haplotypes (C and E). Both haplotypes are common (24 - 42%) in Blue River but elsewhere they were uncommon, with one or the other absent except in the Kiamichi River where they occurred in 5 - 8% of the individuals.

Although not pronounced, there is geographic structure to the genetic variation in *N. suttkusi*. Significant, albeit small, proportions of the diversity in mtDNA (14.3%) and microsatellites (1.2%) were attributable to differences among populations. Despite weak microsatellite divergence, the multi-locus assignment tests found no evidence of hybrids or recent migrants among the sampled populations. These results likely reflect isolation

of upland habitats by inhospitable downstream waters, including the mainstem Red River. First, *N. suttkusi* is not recorded from the Red River mainstem (Humphries and Cashner 1994). Second, tests with upland and lowland cyprinids in Oklahoma show that upland fishes, including *N. suttkusi*, are less tolerant of low oxygen concentrations and high temperatures, conditions more frequently encountered in downstream areas than in cooler, upland situations (Matthews 1988). Third, morphological (Moore and Rigney 1952; Matthews and Gelwick 1988) and allozyme (Echelle et al. 1975) variation in another upland species of the area, orangebelly darter *Etheostoma radiosum*, indicate that the Red River is a formidable longterm barrier to gene flow.

The low level of among-population divergence in *N. suttkusi* likely reflects evolutionarily recent (e.g., late Pleistocene) contact among populations in different Red River tributaries. The population from Muddy Boggy Creek (MB) appears to represent relatively recent exchange or continuing periodic exchange through evolutionary time with the Kiamichi River. The STRUCTURE analysis of microsatellites placed MB with the Kiamichi River population rather than with the other population (Clear Boggy) from the Muddy Boggy River. The MB collection site was in McGee Creek, which is separated by a low divide from Buck Creek, a Kiamichi River tributary that crosses an otherwise mountainous divide between the headwaters of the two systems. Similar headwater transfer between McGee Creek and Buck Creek has also been invoked to explain a geographic pattern of allozyme variation in *E. radiosum* (Echelle et al. 1975). The pattern of divergence across the range of *N. suttkusi* suggests more recent exchanges between the Kiamichi and Little river systems than among the other pairwise combinations of Red River tributaries.

Downstream faunal exchanges among Red River tributaries might have been more common during the Wisconsin glacial interval than they are at present. As previously mentioned, the expansion indicated for *N. suttkusi* during this interval is consistent with Burr's (1978) hypothesis that southern populations were more widely distributed during cooler periods. This suggests that late Pleistocene populations of *N. suttkusi* might have extended into downstream areas, including the Red River. The expanded population sizes detected in this analysis might mirror this range expansion. The suggestion from the Bayesian Skyline plot of a late Wisconsin-Holocene decline in population size agrees with Burr's (1978) suggestion that interglacial periods like the present were times when upland fishes contracted into springfed streams with cooler summertime temperatures.

The Blue River population of *N. suttkusi* likely would have expanded downstream during cooler intervals, but if true, the expansion would have left a signal of expansion in upper Blue River. However, the lack of expansion evidenced here may be due barriers to upstream dispersal. These consist of a series of waterfalls 2 - 3 m high about 40 km downstream of the headwaters where the flow passes over limestone ledges (B. Brown, pers. comm.). Perhaps because of these barriers, Blue River supports two endemic species of darter, *Etheostoma cyanorum* and *E. cf. spectabile*. The former is morphologically the most divergent member of what was described as three subspecies of *E. radiosum* (Moore and Rigney 1952; Matthews and Gelwick 1988) and was recently treated as a separate species (Near et al. 2010). The second endemic, *E. cf. spectabile*, is morphologically divergent from its Red River relatives (Linder, 1955; Distler, 1968) and it is sufficiently divergent mitochondrially that it likely represents an undescribed species

(N. Lang 2010; pers. comm.). None of the other Red River tributaries support endemic species except for the relatively expansive uplands of the Little River drainage, where there are two endemic species, the Ouachita Mountain shiner, *Lythurus snelsoni*, and the leopard darter, *P. pantherina* (Page and Burr 2011).

Mitochondrial DNA studies suggest that contact between Ozark and Red River populations might have been contemporaneous with the suggested late Pleistocene contact among populations of *N. suttkusi*. Levels of divergence in the southern redbelly dace, *Phoxinus erythrogaster* (B. Kreiser, pers. comm.), the Ozark logperch, *P. fulvitaenia* (Lynch 2010), and the redspot chub *Nocomis asper* (A. Echelle et al. unpubl.), are no greater between Red River and Ozark populations than among populations of the latter, and this includes haplotype sharing between populations of the two regions. Thus, the population expansion detected in *N. suttkusi* and the postulated late Pleistocene contact among populations in the Red River system might also extend to other upland species of the Ouachita Highlands, including the Ozark representatives.

References

- Angermeier PL, Schlosser IJ (1989) Species-area relationships for stream fishes. *Ecology* 70, 1450-1462
- Bandelt HJ, Forster P, Röhl A (1999) Median-joining networks for inferring intraspecific phylogenies. *Molecular Biology and Evolution* 16, 37-48
- Berendzen PB, Simons AM, Wood RM, Dowling TE, Secor CL (2008) Recovering cryptic diversity and ancient drainage patterns in eastern North America:

- Historical biogeography of the *Notropis rubellus* species group (Teleostei: Cypriniformes). *Molecular Phylogenetics and Evolution* 46, 721-737
- Brown J, Lomolino M (1998) *Biogeography*. Sinauer, Sunderland
- Burr BM (1978) Systematics of the percid fishes of the subgenus *Microperca*, genus *Etheostoma*. Alabama Museum of Natural History, University of Alabama, Bulletin, 53
- Burr B.M., Page LM (1986) Zoogeography of fishes of the Lower Ohio-Upper Mississippi basin. In: Hocutt CH, Wiley EO (eds) *The zoogeography of North American Fishes*. Wiley, New York, pp287-324
- Cross FB, Mayden, RL, Stewart JD (1986) Fishes in the western Mississippi drainage. In: Hocutt CH, Wiley EO (eds) *The zoogeography of North American freshwater fishes*. Wiley, New York, pp413-456
- Distler DA (1968) Distribution and variation of *Etheostoma spectabile* (Agassiz) (Percidae, Teleostei). *University of Kansas Science Bulletin* 48, 143-208
- Drummond AJ, Rambaut A (2007) BEAST: Bayesian evolutionary analysis by sampling trees. *BMC Evolutionary Biology* 7, 214
- Drummond AJ, Rambaut A, Shapiro B, Pybus OG (2005) Bayesian coalescent inference of past population dynamics from molecular sequences. *Molecular Biology and Evolution* 22, 1185-1192
- Earl DA (2012) STRUCTURE HARVESTER: a website and program for visualizing STRUCTURE output and implementing the Evanno method. *Conservation Genetic Resources* 4, 359-361

- Echelle AA, Echelle AF, Smith MH, Hill LG (1975) Analysis of genic continuity in a headwater fish, *Etheostoma radiosum* (Percidae). *Copeia* 1975, 197-204
- Eliades N, Eliades D (2009) Haplotype Analysis: software for analysis of haplotype data. Forest Goettingen (Germany): Genetics and Forest Tree Breeding, Georg-August University Goettingen
- Evanno G, Regnaut S, Goudet J (2005) Detecting the number of clusters of individuals using the software structure: a simulation study. *Molecular Ecology* 14, 2611-2620
- Excoffier L, Laval G, Schneider S (2005) Arlequin (version 3.0): an integrated software package for population genetics data analysis. *Evolutionary bioinformatics online*, 1, 47
- Excoffier L, Lischer HE (2010) Arlequin suite ver 3.5: a new series of programs to perform population genetics analyses under Linux and Windows. *Molecular ecology resources* 10, 564-567
- Fu YX (1997) Statistical tests of neutrality of mutations against population growth, hitchhiking and background selection. *Genetics* 147, 915-925
- Gerlach G, Jueterbock A, Kraemer P, Deppermann J, Harmand P (2010) Calculations of population differentiation based on GST and D: forget GST but not all of statistics! *Molecular Ecology* 19, 3845-3852
- Goudet J (1995) FSTAT (Version 1.2): A computer program to calculate F-statistics. *Journal of Heredity* 86, 485-486
- Guo SW, Thompson EA (1992) Performing the exact test of Hardy-Weinberg proportion for multiple alleles. *Biometrics* 361-372

- Harpending H (1994) Signature of ancient population growth in a low-resolution mitochondrial DNA mismatch distribution. *Human biology* 591-600
- Hedrick PW (2005) A standardized genetic differentiation measure. *Evolution* 59, 1633-1638
- Hocutt CH, Jenkins RE, Stauffer JR, Jr. (1986) Zoogeography of the fishes of the central Appalachians and central Atlantic coastal plain. In: Hocutt CH, Wiley EO (eds) *The zoogeography of North American freshwater fishes*. Wiley, New York, pp 161-212
- Hubisz MJ, Falush D, Stephens M, Pritchard JK (2009) Inferring weak population structure with the assistance of sample group information. *Molecular Ecology Resources* 9, 1322-1332
- Humphries JM, Cashner RC (1994) *Notropis suttkusi*, a new cyprinid from the Ouachita uplands of Oklahoma and Arkansas, with comments on the status of Ozarkian populations of *N. rubellus*. *Copeia* 1994, 82-90
- Jakobsson M, Rosenberg NA (2007) CLUMPP: a cluster matching and permutation program for dealing with label switching and multimodality in analysis of population structure. *Bioinformatics* 23, 1801-1806
- Jost L (2008) GST and its relatives do not measure differentiation. *Molecular Ecology* 17, 4015-4026
- Kalinowski ST (2005) hp-rare 1.0: a computer program for performing rarefaction on measures of allelic richness. *Molecular Ecology Notes* 5, 187-189

- Lachner EA, Jenkins RE (1971) Systematics, distribution, and evolution of the chub genus *Nocomis* Girard (Pisces: Cyprinidae) of eastern US with a description of a new species. *Smithsonian Contributions to Zoology* 85, 1–97
- Lanave C, Tommasi S, Preparata G, Saccone C (1986) Transition and transversion rate in the evolution of animal mitochondrial DNA. *Biosystems* 19, 273-283
- Lang NJ (2007) Systematics of the subgenus *Oligocephalus* (Percidae: *Etheostoma*) with biogeographic investigations of constituent subspecies groups. Dissertation, Saint Louis University
- Linder AD (1955) The fishes of Blue River in Oklahoma with descriptions of two new percid hybrid combinations. *American Midland Naturalist* 54, 173-191
- Lynch DT (2010) Phylogeography of the Ozark logperch, *Percina caprodes fulvitaenia*, in the Red and Arkansas river basins. Thesis, Oklahoma State University
- Mantel N (1967) The detection of disease clustering and a generalized regression approach. *Cancer research* 27, 209-220
- Matthews WJ (1987) Physicochemical tolerance and selectivity of stream fishes as related to their geographic ranges and local distributions. In: Matthews WJ, Heins DC (eds) *Community and evolutionary ecology of North American stream fishes*. University of Oklahoma Press, Norman, pp111–120
- Matthews WJ, Gelwick FP (1988) Variation and systematics of *Etheostoma radiosum*, the orangebelly darter (Pisces: Percidae). *Copeia* 1988, 543-554
- Matthews WJ, Robison HW (1998) Influence of drainage connectivity, drainage area and regional species richness on fishes of the interior highlands in Arkansas. *American Midland Naturalist* 139, 1-19

- Matthews WJ, Harvey BC, Power ME (1994) Spatial and temporal patterns in the fish assemblages of individual pools in a mid-western stream (USA). *Environmental Biology of Fishes* 39:381-397
- Mayden RL (1985) Biogeography of Ouachita Highland fishes. *Southwestern Naturalist*, 30, 195-211
- Mayden RL (1988) Vicariance biogeography, parsimony, and evolution in North American freshwater fishes. *Systematic Zoology* 37, 329-355
- Metcalf AL (1966) Fishes of the Kansas River system in relation to zoogeography of the Great Plains. *Publications of the Museum of Natural History, University of Kansas* 17, 23-189
- Moore GA, Rigney CC (1952) Taxonomic status of the percid fish *Poeciliichthys radiosus* in Oklahoma and Arkansas, with the descriptions of two new subspecies. *Copeia* 1952, 7-15
- Near TJ, Benard MF (2004) Rapid allopatric speciation in logperch darters (Percidae: Percina). *Evolution* 58, 2798-2808
- Near, T. J., and B. P. Keck. 2006. Dispersal, vicariance, and timing of diversification in *Nothonotus* darters. *Molecular Ecology* 14 3485–3496
- Near TJ, Bossu CM, Bradburd GS, Carlson RL, Harrington RC, Hollingsworth PR, Keck BP, Etnier DA (2011) Phylogeny and temporal diversification of darters (Percidae: Etheostomatinae). *Systematic Biology* 60, 565-595
- Nei M (1987) *Molecular evolutionary genetics*. Columbia University Press, New York
- Page L, Burr B (2011) *Peterson field guide to freshwater fishes of North America north of Mexico*. Houghton Mifflin Harcourt, New York

- Petit JR, Jouzel J, Raynaud D, Barkov N, Barnola JM, Basile I, Bender M, Chappellaz J, Davis M, Delaygue G (1999) Climate and atmospheric history of the past 420,000 years from the Vostok ice core, Antarctica. *Nature* 399, 429-436
- Pritchard JK, Stephens M, Donnelly P (2000) Inference of population structure using multilocus genotype data. *Genetics* 155, 945-959
- Raymond M, Rousset F (2004) GENEPOP version 3.4. Population genetics software for exact tests and ecumenicism. Laboratoire de Genetique et Environment, Montpellier, France
- Rice WR (1989) Analyzing tables of statistical tests. *Evolution* 43, 223-225
- Rogers AR, Harpending H (1992) Population growth makes waves in the distribution of pairwise genetic differences. *Molecular biology and evolution* 9, 552-569
- Rosenberg NA (2004) Distruct: a program for the graphical display of population structure. *Molecular Ecology Notes* 4, 137-138
- Rousset F (2008) genepop'007: a complete re-implementation of the genepop software for Windows and Linux. *Molecular Ecology Resources* 8, 103-106
- Schmidt TR, Bielawski JP, Gold JR (1998) Molecular phylogenetics and evolution of the cytochrome b gene in the cyprinid genus *Lythrurus* (Actinopterygii: Cypriniformes). *Copeia* 1998, 14-22
- Schwemm MR, Echelle AA, Van Den Bussche RA. Isolation and characterization of 10 polymorphic microsatellite markers for the Ouachita Highlands endemic *Notropis suttkusi* (Teleostei: Cyprinidae). *Conservation Genetics Resources*, Doi: 10.1007/s12686-013-0057-8

- Smith GR (1981) Effects of habitat size on species richness and adult body sizes of desert fishes. In: Naiman RJ , Soltz DL (eds) Fishes in North American deserts. Wiley, New York, pp125-172
- Strange RM, Burr BM (1997) Intraspecific phylogeography of North American highland fishes: a test of the Pleistocene vicariance hypothesis. *Evolution* 51, 885–897
- Tajima F (1989a) Statistical method for testing the neutral mutation hypothesis by DNA polymorphism. *Genetics* 123, 585-595
- Tajima F (1989b) The effect of change in population size on DNA polymorphism. *Genetics* 123, 597-601
- Tajima F (1993) Unbiased estimation of evolutionary distance between nucleotide sequences. *Molecular biology and evolution* 10, 677-688
- Tamura K, Peterson D, Peterson N, Stecher G, Nei M, Kumar S (2011) MEGA5: molecular evolutionary genetics analysis using maximum likelihood, evolutionary distance, and maximum parsimony methods. *Molecular biology and evolution* 28, 2731-2739
- Taylor CM (1997) Fish species richness and incidence patterns in isolated and connected stream pools: effects of pool volume and spatial position. *Oecologia* 110, 560-566
- van Oosterhout C, Hutchinson WF, Wills DP, Shipley P (2004) Micro-checker: software for identifying and correcting genotyping errors in microsatellite data. *Molecular Ecology Notes* 4, 535-538

Table 1 Summary mtDNA statistics for six populations of *Notropis suttkusi*.

Abbreviations: sample size (N), number of haplotypes by count (H) and rarefaction (H_R), private haplotypes (H_P), gene diversity (h) and nucleotide diversity (π).

Population	N	H	H_R	H_P	h	π
BR	38	7	5.2	5	0.74	0.0023
CB	29	13	12.0	7	0.89	0.0034
MB	34	3	1.7	0	0.12	0.0004
KR	38	25	19.1	17	0.97	0.0041
LR	39	24	19.2	18	0.96	0.0048
GR	31	16	15.6	9	0.93	0.0035
Mean	34.8	14.7	12.1	9.3	0.77	0.0031

Table 2 Summary statistics microsatellite statistics for six populations of *N. suttkusi*.

Averaged over 10 loci. Abbreviations: sample size (N), number of alleles by count (A) or rarefaction (A_R), number of private alleles (A_P), observed (H_O) and expected (H_E) heterozygosity, and inbreeding coefficient (F).

Population	N	A	A_R	A_P	H_O	H_E	F
BR	36.5	13.3	12.6	0.49	0.679	0.729	0.057
CB	37.5	12.2	11.5	0.09	0.632	0.675	0.041
MC	42.9	16.0	14.4	0.68	0.718	0.776	0.068
KR	39.0	15.2	14.0	0.75	0.720	0.739	0.028
LR	37.5	14.6	13.6	0.79	0.662	0.749	0.098
GR	36.8	15.0	14.0	1.06	0.684	0.731	0.045
Mean	38.4	14.4	13.3	0.64	0.683	0.733	0.056

Table 3 Pairwise comparisons of Jost's \overline{D} (D), fixation indices (Φ_{ST} , F_{ST}) and associated significance values (P_D , $P_{\Phi_{ST}}$, $P_{F_{ST}}$) for six populations of *Notropis suttkusi*. Significant comparisons in bold (stepwise Bonferroni adjusted). Values of 0.000 indicate probabilities less than 0.001.

Pair	mtDNA				Microsatellites			
	D	P_D	Φ_{ST}	$P_{\Phi_{ST}}$	D	P_D	F_{ST}	$P_{F_{ST}}$
BR-CB	0.647	0.001	0.147	0.000	0.140	0.001	0.015	0.000
BR-MB	0.309	0.000	0.244	0.000	0.098	0.001	0.006	0.054
BR-KR	0.706	0.000	0.116	0.000	0.095	0.001	0.012	0.009
BR-LR	0.794	0.000	0.116	0.000	0.151	0.001	0.014	0.000
BR-GR	0.711	0.000	0.167	0.000	0.125	0.001	0.018	0.000
CB-MB	0.804	0.000	0.404	0.000	0.156	0.001	0.022	0.000
CB-KR	0.762	0.000	0.081	0.000	0.233	0.001	0.029	0.000
CB-LR	0.923	0.000	0.075	0.000	0.224	0.001	0.021	0.000
CB-GR	0.919	0.000	0.105	0.000	0.194	0.001	0.022	0.000
MB-KR	0.840	0.000	0.251	0.000	0.011	0.347	0.003	0.117
MB-LR	1.000	0.000	0.257	0.000	0.046	0.023	0.003	0.198
MB-GR	0.994	0.000	0.399	0.000	0.043	0.043	0.005	0.072
KR-LR	0.463	0.015	0.018	0.045	0.051	0.018	0.009	0.009
KR-GR	0.602	0.001	0.052	0.000	0.070	0.002	0.003	0.081
LR-GR	0.204	0.071	0.032	0.018	0.053	0.019	0.000	0.702

Table 4 Molecular demographic parameters and significance tests for six populations of *Notropis suttkusi*. Estimated from mtDNA (*cytb*). Abbreviations: mean number of pairwise differences (τ , Rogers and Harpending 1992), sum of squares deviation from model of expansion (SSD_{exp} , Excoffier et al. 2005), Harpending's raggedness index (r , Harpending 1994), neutrality tests of Fu's F_S (Fu 1997) and Tajima's D (Tajima 1989a,b). Significant values in bold.

Population	τ	SSD_{exp}	P_{SSD}	r	P_r	F_S	P_{F_S}	D	P_D
BR	4.1	0.075	0.07	0.25	0.02	0.72	0.673	-0.10	0.515
CB	5.4	0.013	0.31	0.03	0.59	-2.96	0.096	-1.47	0.043
MB	-	-	-	-	-	-0.29	0.330	-2.00	0.001
KR	4.9	0.002	0.50	0.02	0.55	-14.98	0.001	-1.70	0.022
LR	5.8	0.002	0.44	0.02	0.43	-13.15	0.000	-1.83	0.016
GR	3.3	0.007	0.36	0.02	0.50	-7.03	0.003	-1.44	0.065
Overall	4.9	0.005	0.17	0.02	0.31	-25.59	0.000	-2.17	0.000

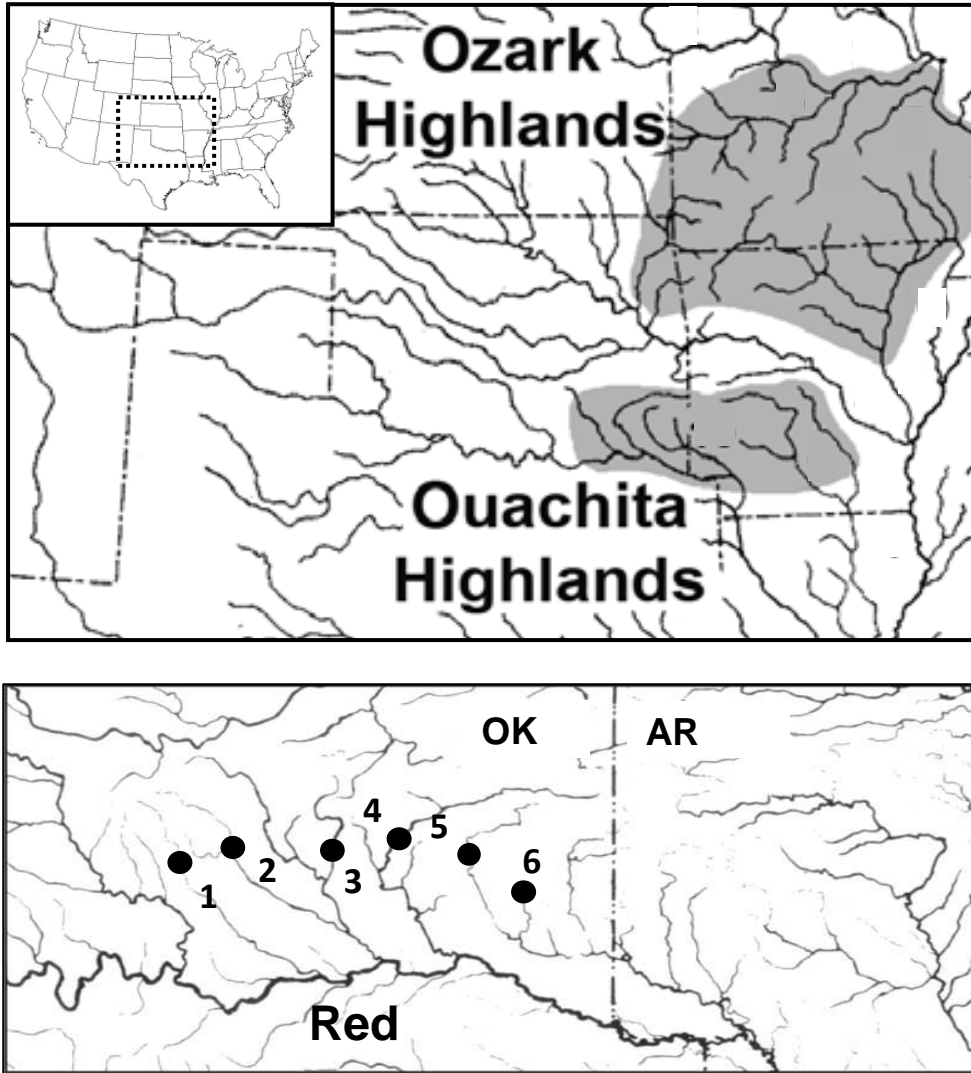

Figure 1 Top Panel, Interior Highlands of North America (shaded). Lower panel, Ouachita Highlands region with sample localities of *Notropis suttkusi* of the Red River basin: 1) Blue River (BR), 2) Clear Boggy River (CB), 3) McGee Creek tributary of Muddy Boggy River (MB), 4) Kiamichi River (KR), 5) Little River (5) and 6) Glover River (GR).

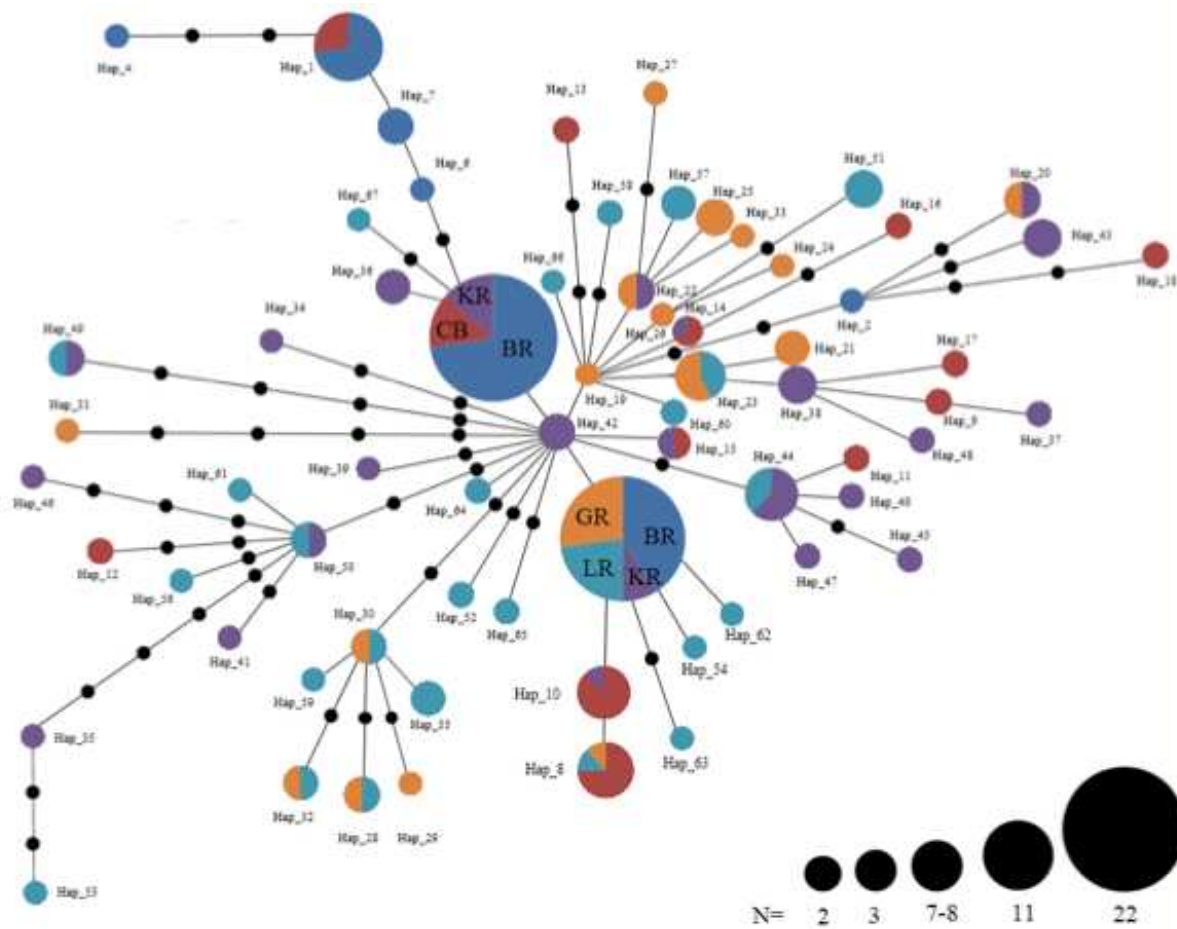

Figure 2 Haplotype network of mtDNA (*cytb*) sequences of five sampled localities of *Notropis suttkusi* (Populations: BR, CB, KR, LR, and GR. Population MB was excluded for clarity due to low haplotype diversity). Colors represent sampled localities and sizes are proportional to haplotype frequency. Black circles represent unsampled haplotypes of one mutational step (base pair)

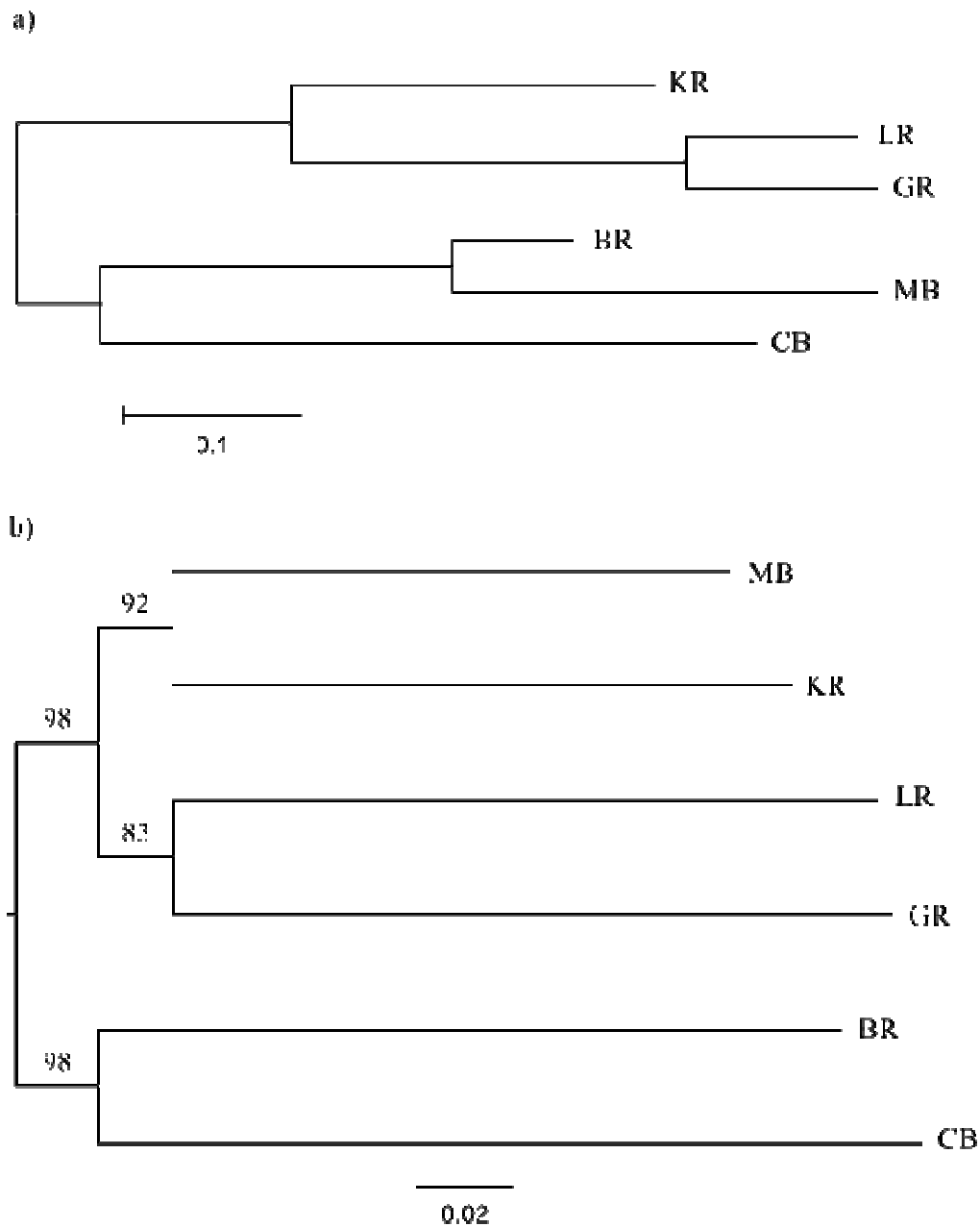

Figure 3 Neighbor-joining trees for *Notropis suttkusi* computed from genetic distances. a) mtDNA tree (Φ_{ST} distance); b) tree based on 10 microsatellite loci (Cavalli-Sforza chord distance, bootstrapped over loci, 1000 rep.) Populations: BR, CB, MB, KR, LR, and GR). Note: MB nearly fixed for common mtDNA of BR.

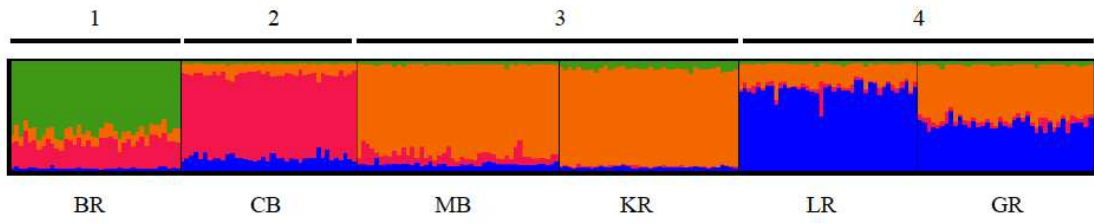

Figure 4 Bayesian genetic clusters ($k = 4$) identified from assignment of 241 individuals scored at 10 microsatellite loci of *N. suttkusi*.

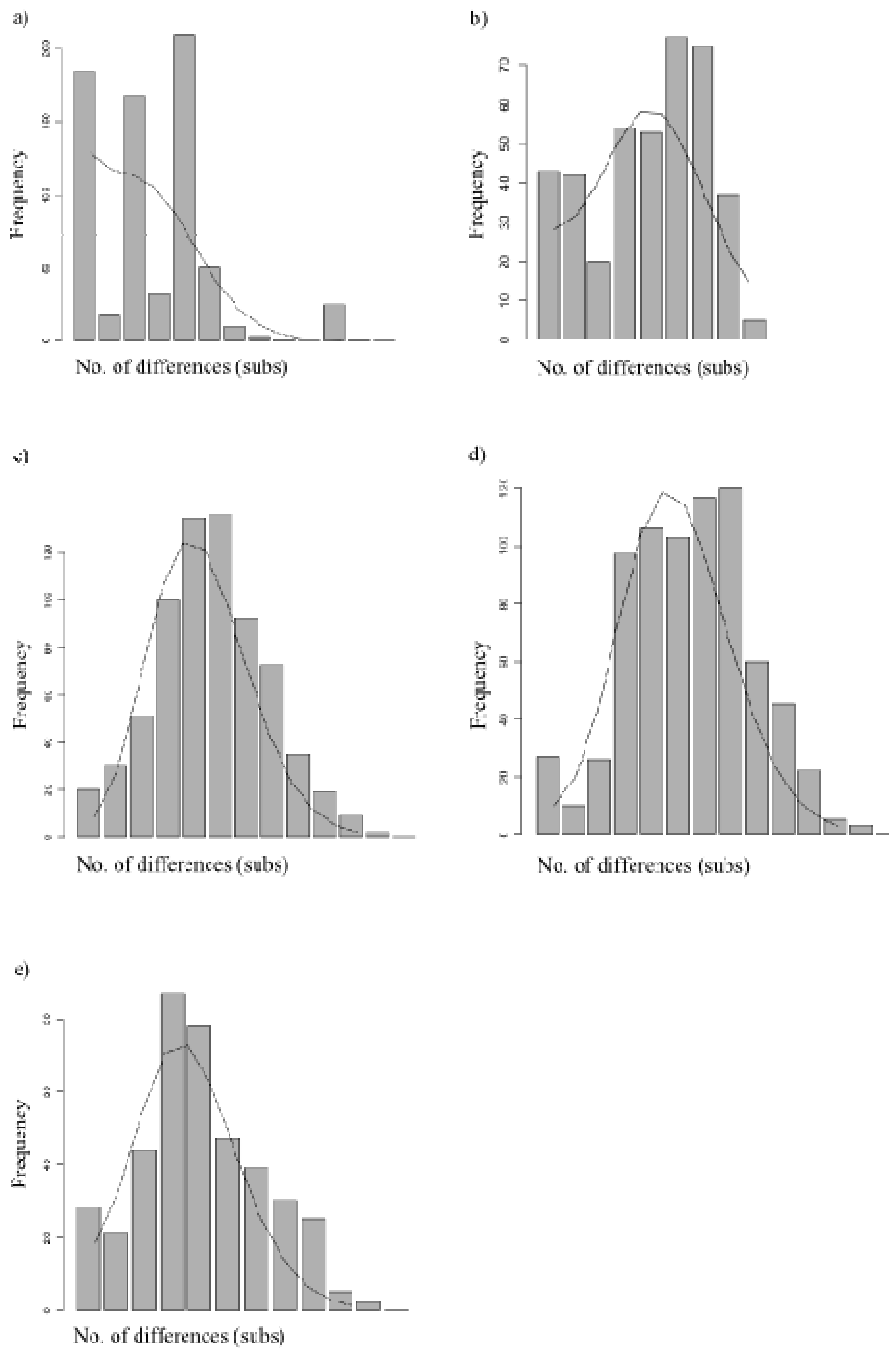

Figure 5 Mismatch distributions for five populations of *Notropis suttkusi*. a) BR, b) CB, c) KR, d) LR, and e) GR]. Superimposed curve indicates expected number of substitutions under a model of population expansion. Sample MB was excluded from this analysis due to low haplotype diversity.

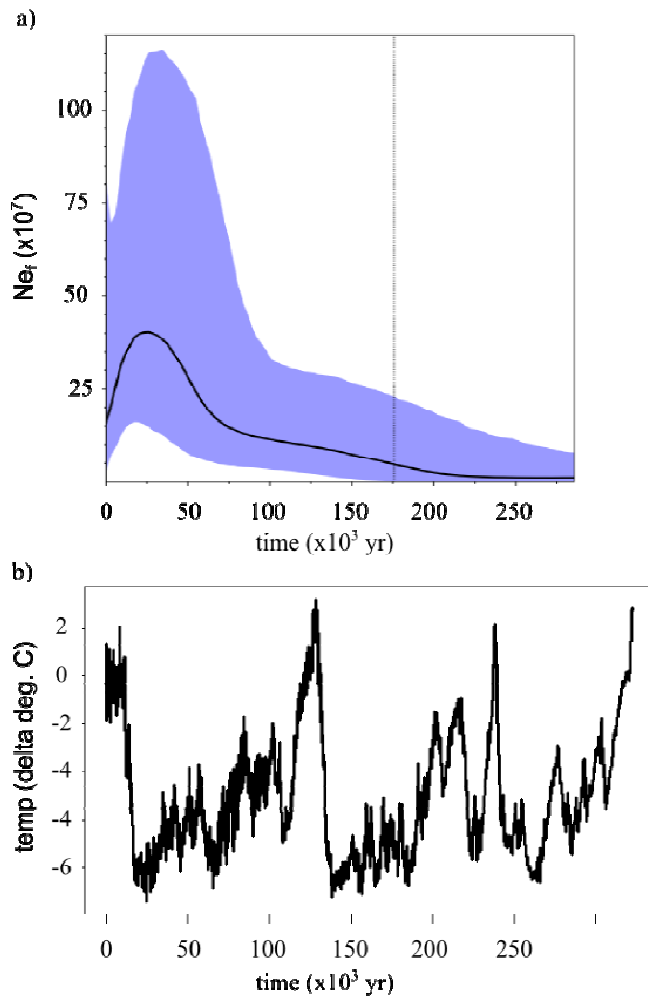

Figure 6 Bayesian skyline plot for pooled individuals of *N. suttkusi* from populations showing mismatch distributions indicative of population expansion (CB, MB, LR and GR). Lower graph = global temperature change from Vostok Ice Cores from present to 250,000 ya. (redrawn from data provided in Petit et al. 2001).

Appendix A MtDNA (*cytb*) haplotypes of *Notropis suttkusi* sampled from six collection sites. Population abbreviations as in Figure 1.

Haplotype	Populations						total
	BR	CB	MB	KR	LR	GR	
A	8	3					11
B	1						1
C	16	3	33	3			55
D	1						1
E	9			2	5	6	22
F	1						1
G	2						2
H		6			1	1	8
I		1					1
J		7		1			8
K		1					1
L		1					1
M		1					1
N		2		1			3
O		1		1			2
P		1					1
Q		1					1
R		1					1
S						1	1
T				1		1	2

Populations							
Haplotype	BR	CB	MB	KR	LR	GR	total
U						2	2
V			1	3		3	7
W			1		3	4	8
X						1	1
Y						3	3
Z						1	1
AA						1	1
BB					1	1	2
CC						1	1
DD				1		1	2
EE						1	1
FF					1	1	2
GG						1	1
HH				1			1
II				1			1
JJ				2			2
KK				1			1
LL				3			3
MM				1			1
NN				1			1
OO				1			1
PP				2			2
QQ				3			3

Populations							
Haplotype	BR	CB	MB	KR	LR	GR	total
RR				5	3		8
SS				1			1
TT				1			1
UU				1			1
VV				1			1
WW				1	1		2
XX				1	1		2
YY					3		3
ZZ					1		1
AAA					1		1
BBB					1		1
CCC					2		2
DDD					3		3
EEE					2		2
FFF					1		1
GGG					1		1
HHH					1		1
III					1		1
JJJ					1		1
KKK					1		1
LLL					1		1
MMM					1		1
NNN					1		1

Populations							
Haplotype	BR	CB	MB	KR	LR	GR	total
OOO					1		1
total	38	29	35	40	39	30	211

Appendix B Marker characteristics for 10 microsatellite loci. Abbreviations include the sample size (N), number of alleles by count (A) and rarefaction (A_R), observed heterozygosity (H_O), expected heterozygosity (H_E), inbreeding coefficient (F), and Hardy-Weinberg probability (P_{HW}).

Locus: A1

	BR	CB	MB	KR	LR	GR	mean
N	35	36	44	40	40	38	38.833
A	5	5	5	5	4	4	4.667
A_R	4.857	4.974	4.652	4.985	3.94	3.992	4.772
H_O	0.657	0.639	0.659	0.8	0.425	0.579	0.627
H_E	0.707	0.707	0.682	0.705	0.589	0.61	0.667
F	0.07	0.096	0.033	-0.135	0.278	0.051	0.066
P_{HW}	0.501	0.879	0.205	0.86	0.132	0.669	0.541

locus: A4

	BR	CB	MB	KR	LR	GR	mean
N	38	39	45	40	39	36	39.500
A	4	5	6	8	6	8	6.167
A_R	3.999	4.885	5.645	6.986	5.718	7.756	5.832
H_O	0.474	0.256	0.667	0.575	0.538	0.611	0.520
H_E	0.491	0.257	0.623	0.577	0.565	0.55	0.511
F	0.036	0.001	-0.07	0.003	0.048	-0.111	-0.016
P_{HW}	0.801	0.851	0.598	0.997	0.864	0.934	0.841

locus: A103

	BR	CB	MB	KR	LR	GR	mean
<i>N</i>	38	39	45	40	40	35	39.500
<i>A</i>	3	3	4	3	4	4	3.500
<i>A_R</i>	2.95	2.949	3.667	3	3.94	3.855	3.394
<i>H_O</i>	0.132	0.179	0.311	0.275	0.4	0.371	0.278
<i>H_E</i>	0.125	0.167	0.326	0.339	0.412	0.318	0.281
<i>F</i>	-0.053	-0.077	0.046	0.188	0.028	-0.167	-0.006
<i>P_{HW}</i>	0.979	0.945	0.895	0.278	0.574	0.935	0.768

locus: B9

	BR	CB	MB	KR	LR	GR	mean
<i>N</i>	31	35	41	37	39	39	37.000
<i>A</i>	16	12	16	18	25	23	18.333
<i>A_R</i>	15.804	11.562	15.097	16.906	22.232	20.771	17.062
<i>H_O</i>	0.871	0.6	0.732	0.811	0.769	0.846	0.772
<i>H_E</i>	0.884	0.791	0.911	0.891	0.93	0.91	0.886
<i>F</i>	0.015	0.241	0.197	0.09	0.173	0.07	0.131
<i>P_{HW}</i>	0.215	0.049	0.006	0.13	0.008	0.925	0.222

locus: B106

	BR	CB	MB	KR	LR	GR	mean
<i>N</i>	37	33	36	34	36	37	35.500
<i>A</i>	6	7	10	8	9	13	8.833
<i>A_R</i>	5.805	6.895	9.803	7.881	8.641	12.043	8.511

H_O	0.622	0.758	0.75	0.794	0.722	0.757	0.734
H_E	0.731	0.671	0.856	0.809	0.83	0.871	0.795
F	0.15	-0.129	0.124	0.019	0.13	0.131	0.071
P_{HW}	0.57	0.828	0.612	0.636	0.161	0.507	0.552

locus: C109

	BR	CB	MB	KR	LR	GR	mean
N	38	38	44	40	32	38	38.333
A	12	9	17	9	7	12	11.000
A_R	11.096	8.276	14.34	7.662	6.812	10.189	9.729
H_O	0.605	0.579	0.545	0.3	0.5	0.289	0.470
H_E	0.628	0.54	0.598	0.294	0.422	0.331	0.469
F	0.036	-0.072	0.088	-0.019	-0.185	0.126	-0.004
P_{HW}	0.817	0.809	0.791	1	1	0.000 *	0.883

locus: D3

	BR	CB	MB	KR	LR	GR	mean
N	38	39	42	40	30	35	37.333
A	20	18	25	28	19	21	21.833
A_R	18.834	16.984	21.38	25.028	19	19.847	20.179
H_O	0.789	0.744	0.833	0.85	0.6	0.771	0.765
H_E	0.93	0.891	0.927	0.943	0.928	0.929	0.925
F	0.151	0.165	0.101	0.098	0.353	0.17	0.173
P_{HW}	0.381	0.067	0.973	0.245	0.039	0.011	0.286

locus: D102

	BR	CB	MB	KR	LR	GR	mean
<i>N</i>	35	39	43	39	40	33	38.167
<i>A</i>	26	23	27	18	26	19	23.167
<i>A_R</i>	24.314	20.704	23.169	16.995	23.36	18.516	21.176
<i>H_O</i>	0.857	0.846	0.837	0.897	0.9	0.879	0.869
<i>H_E</i>	0.938	0.928	0.939	0.923	0.939	0.917	0.931
<i>F</i>	0.087	0.089	0.108	0.027	0.042	0.042	0.066
<i>P_{HW}</i>	0.11	0.62	0.34	0.044	0.58	0.95	0.441

locus: D108

	BR	CB	MB	KR	LR	GR	mean
<i>N</i>	37	39	45	40	39	39	39.833
<i>A</i>	18	19	24	27	20	20	21.333
<i>A_R</i>	16.813	17.197	22.447	25.002	18.486	18.755	19.783
<i>H_O</i>	0.811	0.744	0.844	0.950	0.795	0.846	0.832
<i>H_E</i>	0.915	0.869	0.949	0.950	0.927	0.924	0.922
<i>F</i>	0.113	0.144	0.110	0.000	0.142	0.084	0.099
<i>P_{HW}</i>	0.502	0.445	0.058	0.004	0.506	0.719	0.372

locus: D111

	BR	CB	MB	KR	LR	GR	mean
<i>N</i>	38	38	44	40	40	38	39.67
<i>A</i>	23	21	26	28	26	26	25.00
<i>A_R</i>	21.662	20.113	23.322	25.917	24.079	24.002	23.183

H_O	0.974	0.974	1	0.95	0.975	0.895	0.961
H_E	0.939	0.928	0.946	0.956	0.949	0.948	0.944
F	-0.037	-0.049	-0.057	0.006	-0.027	0.057	-0.018
P_{HW}	0.424	0.86	0.233	0.166	0.852	0.685	0.537

* significant deviation from HWE after sequential Bonferroni correction for 60 tests

P_{HW} values in bold significant before Bonferroni correction ($\alpha = 0.05$)

CHAPTER III

GENETICALLY EFFECTIVE POPULATION SIZES AND ANTHROPOGENIC RANGE FRAGMENTATION IN THE THREATENED LEOPARD DARTER: THE ROLE OF LARGE- RESERVOIR CONSTRUCTION

Reservoir dams increasingly fragment aquatic habitats, and understanding the genetic impacts for threatened species is crucial to informed management. In this study of the federally endangered *Percina pantherina*, a species restricted to the Little River (Oklahoma and Arkansas), estimates of contemporary and historical genetic effective population sizes (N_e) and traditional population genetic measures were used to evaluate effects associated with large-reservoir dam construction in the 1960s. Results from mitochondrial DNA (cytochrome b) and microsatellites (eight loci) showed consistent evidence of historically large effective population sizes and moderate gene flow among populations. Coalescence analyses indicate that contemporary N_e values (5 to 69) are four to five orders of magnitude lower than historic values and the associated estimate of time since decline is consistent with dam construction as the causative factor. The point estimates ranged from 32 to 186 yrs, with lower bounds of the 95% credibility (4-21 yrs) well within the four decades since dam construction. The results of this study emphasize a need for managers to implement a program of artificial gene flow among populations.

Introduction

Understanding the impacts of anthropogenic barriers to gene flow on the genetic structure of natural populations allows assessment of rates of evolutionary change across subpopulations and the potential negative effects for wildlife conservation (Allendorf and Luikart 2007). Lotic systems worldwide are increasingly impacted by dams that subdivide populations and heighten the rate of loss of genetic diversity (Helfman 2007). Low levels of genetic variation have fitness consequences at short and long-term scales by increasing inbreeding and by limiting adaptive potential, respectively (Allendorf et al. 1987). In addition to genetic effects, fragmentation leading to small, isolated populations also heightens the frequency of local extirpations by demographic and environmental stochasticity (Lande 1988; Morita and Yokota, 2002) a factor that can be especially intense in riverine systems (Fagan 2002). Regardless of whether extirpations result from such factors or from genetic deterioration, barriers to dispersal preclude re-colonization, causing a progression toward extinction of the species.

Studies of the genetic consequences of damming rivers have dealt with a variety of fishes, including salmonids (Neraas and Spruell 2001; Yamamoto et al. 2004; Wofford et al. 2005), a percid (Laroche and Durand 2004), several cyprinids (Aló and Turner 2005; Blanchet et al. 2010) and a stickleback (Raeymaekers et al. 2008). Such studies invariably suggest negative genetic effects of damming, but interpretation is confounded by the possibility that earlier historical factors were involved (Yamamoto et al. 2004; Raeymakers et al. 2008). Exceptions directly implicating effects of dams include (1) a negative relationship between diversity and time elapsed since dam construction in white-spotted charr *Salvelinus leucomaenis* (Yamamoto et al. 2004); (2) that populations of

each of four cyprinid species in France showed less genetic diversity in an artificially fragmented river than in an un-fragmented river (Blanchet et al. 2010), (3) the indication that historical effective population size (N_e) in Rio Grande silvery minnow *Hybognathus amarus* was orders of magnitude greater than present N_e (Aló and Turner 2005); and (4) a landscape study of threespine stickleback *Gasterosteus aculeatus* that found a marked relationship between kinds of barriers to gene flow and genetic diversity (Raeymaekers et al. 2008).

In this study, I test the hypothesis that reservoirs and their dams have impacted the genetic structure of the federally threatened (USFWS 1978) leopard darter (Percidae: *Percina pantherina*). My approach is to use molecular based analyses of historical demography to evaluate the prediction that effective population sizes have declined and that the decline is within a timeframe consistent with the hypothesis that dams are the cause. I also use the results of this study to develop recommendations for the conservation of the species. A previous allozyme-based assessment of genetic variation in *P. pantherina* found little divergence among populations ($F_{ST} = 0.10$) of *P. pantherina* (Echelle et al. 1999). This suggests historically high levels of gene flow prior to construction of large reservoirs on the system. This is re-evaluated herein and the results, together with alarmingly small estimates of present effective population sizes, form the basis of a recommendation to implement a program of genetic exchange among populations.

Percina pantherina is a small (~90 mm TL) percid endemic to the Little River basin of southwestern Arkansas and southeastern Oklahoma, USA. It occupies slow-water, upland pools of moderate sized streams in the Ouachita Highlands (Jones et al.

1984; James and Maughan 1989). The species is known from five Little River tributaries (Fig. 1), but annual monitoring by resource agencies suggests that it may be extirpated from the Rolling Fork (D. Fenner, pers. comm.). Threats to the species, in addition to effects of range fragmentation by dams, include silvicultural activity (road building, siltation) and pollution from the mining, poultry and swine industries (Eley et al. 1975; Rutherford et al. 1992, James and Collins 1993, Zale et al. 1994). Reservoirs on Little River tributaries known to support *P. pantherina* were completed between 1966 and 1969 (west to east): Little River, 1969; Mountain Fork River, 1969; Rolling Fork River, 1966; and Cossatot River, 1968. Critical habitat designation and federal listing (USFWS 1978) prevented dam construction on the Glover River in 1978, although congressional authority to construct the dam remains in effect. *Percina pantherina* is not known from reservoirs, indicating they are unsuitable for the species (Zale et al. 1994).

Materials and Methods

Sampling and DNA extraction—Seven collections of *Percina pantherina* ($N = 163$) were made by hand net during summer snorkel surveys of 2008 and 2009 (Fig. 1). Samples include two collections from the upper Little River (LR1, LR2), one from the Glover River (GR), three from the Mountain Fork River (MF, BC, BE) and one from the Cossatot River (CR). Fin clips were removed and preserved in 95% ethanol in the field and the fish were immediately released at site of capture. Genomic DNA was extracted from fin clips with the DNeasy Blood and Tissue Kit (Qiagen Corp.).

Molecular markers—Microsatellite variation was assessed with eight tetra-nucleotide loci (A5, A103, B5, B6, B102, B103, B105, C105) specifically developed for this study (chapter 6; Schwemm and Echelle 2013). The following PCR amplification parameters were used for all loci: 95°C for 12 min, 35 cycles of 94°C for 40 s, 57°C for 40 s, 72°C for 30 s, and 72°C for 4 min. The reaction mix (15 µL total volume) contained 1-3 ng of template DNA in 1 µL ddH₂O, 0.5 µL of each primer (10 µM), 4 µL ddH₂O and 9 µL True Allele PCR mix (Applied Biosystems, Inc.). Capillary electrophoresis using an ABI 3130 Genetic Analyzer was performed on solutions containing the combined post-amplification reaction mixes from 2-3 loci (0.5 µL each locus), 0.5 µL 400HD ROX size standard (Applied Biosystems, Inc.), and 9 µL formamide (Applied Biosystems, Inc.). Length variants were visualized and genotyped using GeneMarker 1.91 (SoftGenetics LLC, State College, Pennsylvania, USA). Genotyping errors were evaluated by rescoring 5% of individuals.

Mitochondrial sequence diversity was assessed using partial cytochrome *b* (*cytb*) sequences (843 bp). Individuals surveyed for mtDNA variation were the same as those genotyped for microsatellites, but included only a single sample from the upper Little River, comprised of pooling LR1 and LR2 due to inconsistent amplification of *cytb*. Sequences were amplified and sequenced in both directions using PCR primers GLU (5'-GAC TTG AAG AAC CAC CGT TG-3') and THR (5'-TCC GAC ATT CGG TTT ACA AG-3') from Near et al. (2000). Amplification for *cyt b* was carried out using 25-µl PCR reactions: 0.125-µl (5 U/µL) Promega GoTaq® Flexi DNA polymerase (Madison, Wisconsin); 5-µl [5X] Promega PCR buffer; 2.5-µl [25 mM] MgCl₂; 1.25-µL [0.5 µM] each, forward and reverse primers; 0.2-µL [25mM] dNTPs; 13.7 µL ddH₂O; 1-µL [1-4

ng] DNA. The thermal profile used in both reactions included 35 cycles of 94°C, 30 s; 53°C, 30 s; 72°C, 90 s; plus an initial denaturing at 94°C for 60 s and a final extension at 72°C for 7 m. The products were cleaned for sequencing with either the Wizard SV PCR cleanup kit (Promega, Madison, Wisconsin) or EXOSAP (USB Corp., Cleveland, Ohio) with a modified temperature profile of 37° C for 30 min, 80° C for 15 min and 12° C for 5 min. I used the amplification primers in sequencing reactions and resolved the sequences with an ABI model 3130 sequencer (Applied Biosystems, Foster City, California). I used Geneious ver. 5.6.4 for manual sequence editing and alignment (Biomatters Ltd., New Zealand).

Data Assumptions—Microsatellite loci were tested for deviations from Hardy-Weinberg expectations (HWE) and gametic disequilibrium with exact tests in GENEPOP 4.2 (Raymond and Rousset 2004; Rousset 2008) using the Markov-chain approach with 5000 dememorizations, 500 batches, and 5000 iterations (Guo and Thompson 1992). Significance was determined by sequential Bonferroni correction adjusted for the number of tests for $\alpha = 0.05$ (Rice 1989). We assessed the potential impact of null alleles using MICRO-CHECKER (van Oosterhout et al. 2004). For mitochondrial coding sequences, I evaluated the potential impact of selection using neutrality tests of Tajima's D (Tajima 1989), and Fu and Li's D and Fu's F (Fu and Li 1993, Fu 1996), and by assessing the number of synonymous and replacement substitutions.

Variation within populations— Microsatellite variation within populations was summarized for number of alleles, and allelic richness (A_R) and private alleles (A_P)

adjusted by rarefaction using FSTAT v. 2.9.3.2 (Goudet 1995) and HP-RARE (Kalinowski 2005), respectively. Observed and expected heterozygosities were calculated in GENEPOP 4.2 and significance was adjusted for the number of tests.

The mtDNA data for each population were summarized for number of haplotypes, haplotype richness using HAPLOTYPE ANALYSIS 1.04 (Eliades and Eliades 2009). Haplotype diversity (h ; Nei 1987) and nucleotide diversity (π ; Tajima 1993) were computed with ARLEQUIN v. 3.5.1.3 (Excoffier and Lischer 2010). Substitutions between haplotypes and their relationship with geography were visualized by a haplotype network using the median-joining method in NETWORK 4.5.1.6 (Bandelt et al. 1999).

Variation among populations—Geographic structure was evaluated using a hierarchical analysis of molecular variance (AMOVA) in ARLEQUIN for both microsatellite and mtDNA (Excoffier and Lischer 2010), with tests of significance calculated from 10,000 permutations. Pairwise tests of F_{ST} (microsatellites) and Φ_{ST} (mtDNA) were also calculated in ARLEQUIN (10,000 permutations). For mtDNA sequences, I used the Tamura-Nei model of nucleotide evolution, selected by AICc in MEGA 5.2 (Tamura et al. 2011). The F_{ST} index of pairwise divergence was used to pool across sample sites for subsequent analyses.

To assess the contemporary impacts of fragmentation on gene flow, I used the test for migrants implemented in STRUCTURE 2.3.4 (Pritchard et al. 2000, Hubisz et al. 2009, <http://prich.bsd.uchicago.edu/structure.html>). This algorithm (MIGRPRIOR option) employs a Bayesian clustering approach similar to the method used to estimate the number of genetically distinct groups (k), but differs in that this approach employs strong

population priors of sampling locality. Only individuals with considerable signal are identified as migrants or recent backcrosses. For this analysis, I evaluated ongoing gene flow among the four distinct populations (identified from the pairwise F_{ST} values) by recoding individuals to reflect the four sampled tributaries. I ran four runs, each consisting of 1,000,000 iterations with the first 50,000 discarded as burn-in.

Genetic Effective Size—Allele counts and frequencies were used in a coalescent approach to model recent demographic change in the effective population (N_e) size for five populations (LR, GR, MF-BE, BC and CR) identified as distinct by F_{ST} . The coalescent approach uses more of the available data than single summary statistics and simulations (Girod et al. 2011) indicate it to be more effective at recovering population bottlenecks than the M-ratio (Garza and Williamson 2001) and heterozygosity excess (Cornuet and Luikart 1996) tests.

Estimates of N_e were generated under a step-wise mutation model (SMM) using the software package MSVAR 1.3 (Beaumont 2003), which estimates jointly the population parameters of ancestral population size (N_{e1}), current population size (N_{e0}), and time (t) in years since the beginning of the increase or decline phase. Change in N_e was estimated under a model of exponential change as recommended by Beaumont (1999) for short-term decline phases. We used a generation time of one year (James et al. 1991) to convert generation time to calendar years. The mean and 95% credibility limits (HPD) were calculated for N_{e0} , N_{e1} , and t from the posterior distributions after 8×10^7 iterations, discarding the initial 30% as burn-in. Parameter estimates and HPD values were obtained by using the R package CODA (R Development Core Team 2009) to

combine two replicate MCMC chains for each population. For comparison, current population sizes were estimated by two other approaches: the LDNe (Waples and Do 2008) method, which utilizes the relationship between genetic drift and nonrandom associations of alleles at different loci, and OneSAMP (Tallmon et al. 2008), a multiple-summary statistic using approximate Bayesian computation. With LDNe, population sizes and 95% confidence limits were computed after excluding alleles occurring at frequencies < 0.02 (Waples and Do 2010). OneSAMP provided 95% Bayesian credibility limits for estimates.

Results

Mitochondrial DNA—Survey of 112 individuals in six populations revealed 12 *cytb* (843 bp) haplotypes (Table 1). There were 46 variable sites with five (10.9%) amino acid substitutions and no evidence of deviation from neutrality ($P > 0.05$ for Fu and Li's F , Fu's D or Tajima's D).

Five individuals from the Mountain Fork River (2 each from MF and BE, 1 from BC) showed a highly divergent haplotype (L) that differed from the common haplotype (H) by 34 substitutions (Fig. 2). A similar haplotype (Genbank AF386558) was previously reported for *Percina pantherina* (Near et al. 2002), and differed from haplotype L by only 3 bp substitutions in 843 bp (0.4%). Also, divergent haplotype L differed from the widespread blackside darter, *P. maculata*, by 8 of 843 bp (0.95%). Excluding haplotype L, the number of substitutions among haplotypes of *P. pantherina* averaged 2.0 (0.24%; maximum = 5 bp, 0.59%).

The detected number of haplotypes per population ranged from 2 in GR and CR to 6 in MF (Table 2). Mean haplotype diversity (h) was 0.575, and ranged from 0.309 to 0.758, with the lowest values occurring in CR and highest in MF. Nucleotide diversity (π) ranged from 0.00050 to 0.01157. The maximum was 0.00184 after excluding populations with the divergent haplotype L. Private haplotypes ranged from 0 to 2 per sample site, including five private haplotypes unique to the Mountain Fork River (sites MF, BC and BE).

AMOVA indicated that 67.5% of total mtDNA diversity was attributable to within-population variation (Table 3). Differences among populations in different Little River tributaries accounted for 30.5% of total diversity ($P < 0.001$), leaving a small, statistically insignificant percentage (2.9%; $P = 0.48$) attributable to differences among populations within tributaries. Correspondingly, all pairwise Φ_{ST} tests were statistically significant except those combinations of populations from the same river (MF, BC, and BE from Mountain Fork River; Table 4). Levels of among-tributary divergence were highest for CR ($\Phi_{ST} = 0.36-0.69$ versus 0.15-0.55), as reflected in the topology of the mtDNA tree summarizing Φ_{ST} distances (Fig. 3). The Mantel test of association between genetic and stream distances among populations was significant ($r = 0.74$; $P = 0.01$), indicating isolation-by-distance.

Microsatellites—Genotypes of 163 individuals at 8 loci showed no significant deviations from HWE and no evidence of linkage disequilibrium after Bonferroni correction. All loci were polymorphic with number of alleles ranging from very low (1.4 and 2.1 for loci A5 and B103, respectively) to moderate (8.8 and 9.6 for loci B102 and B105; Appendix

A). Allelic diversity was similar among most populations. The average number of alleles across loci was lowest for CR (3.7) and ranged from 5.4 to 6.6 for the remaining populations (Table 5). Mean expected heterozygosity (H_e) was also lowest in CR (0.45 versus 0.53 to 0.62). AMOVA indicated that 88.7% of total mtDNA diversity was attributable to within-population variation (Table 3). Differences among populations in different Little River tributaries accounted for 10.1% of total diversity ($P < 0.002$), leaving a small but statistically significant percentage (0.5%; $P < 0.001$) attributable to differences among populations within tributaries. All pairwise tests F_{ST} tests were highly significant ($P < 0.0001$) except for those involving pairs from the same tributaries (Little River and Mountain Fork River; Table 6). The Fisher exact tests (not shown) gave similar results. Levels of among-tributary divergence were highest for CR ($F_{ST} = 0.16-0.20$ versus 0.04-0.12). In the tree summarizing microsatellite divergences CR was a divergent member of a group that included the three samples from the Mountain Fork River (Fig. 3); GR clustered with the two populations from the upper Little River. The Mantel test of association between genetic and stream distances was significant ($r = 0.86$; $P = 0.004$), indicating isolation-by-distance.

The STRUCTURE search for multilocus genotypes indicative of gene flow among Little River tributary populations revealed only weak evidence of recent immigration. Four independent runs showed similar results, and the results of one is presented in Fig. 4. All except two individuals were unambiguously assigned to the population of collection. The exceptions were in the Little River (LR1-LR2) and Mountain Fork (MF-BC-BE) tributaries, where one individual of each tributary showed evidence of hybrid ancestry from CR ($Q = 0.28$ and 0.18, respectively).

Genetic effective population size—Based on a lack of significant divergence between MF and BE or between the LR1 and LR2 populations, the individuals from these locations were pooled for population size estimates. The coalescent method (MSVAR) indicated dramatic declines from historical population sizes for all sample populations (Table 7). Estimates of historic effective population sizes (N_{e1}) ranged from 125,892 to 275,422, with the lowest estimate for CR. In contrast, the estimates of present effective population sizes (N_{e0}) ranged from 5.2 (95% HPD = 0-50) to 69.2 (HPD = 17-417). The timing of decline was estimated at less than 200 years for all sites. The lower bounds of the 95% HPD ranged from a high of 40 yrs (MF-BE) to a low of 4 yrs (BC). Similarly low point estimates of current N_e were obtained with OneSAMP and LDNe except for somewhat higher LDNe estimates for the LR1/LR2 ($N_e = 103$) and MF/BE ($N_e = 850$) populations; these were the only estimates greater than $N_e = 81$.

Discussion

The microsatellite analysis of historical demography is consistent with the hypothesis that effective population sizes in *Percina pantherina* have declined in response to the construction of large-reservoir dams on the Little River system. The mean of the coalescence-based estimates of historical N_e (207,607) was four orders of magnitude greater than the mean of current N_e estimates (27), and the lower bounds of the 95% credibility intervals for the estimated times since decline (mean = 16 yrs; range = 8-40) were well within the four decades since dams were completed on the system.

The analysis of isolation by distance (IBD) is also informative for past population structure in *P. pantherina*. The strong IBD signals for both mtDNA ($r = 0.74$) and microsatellites ($r = 0.87$) indicated that, prior to dam construction, *P. pantherina* existed as a metapopulation with migration-drift equilibrium among genetically divergent subpopulations (Slatkin 1993). At that time, the existing populations were divergent as a result of intrinsically-limited dispersal ability relative to the geographic distances separating them, or as a result of environmental limitations to free exchange among populations. In either case, there was sufficient gene flow that the present percentage of microsatellite diversity attributable to differences among populations in different Little River tributaries is relatively small (10%). The higher percentage for mtDNA (31%) likely reflects greater genetic drift because of the fourfold difference in effective population sizes for the two genomes.

Connectedness between upland populations and downstream habitats prior to dam construction is indicated by the presence of the mtDNA of *P. maculata* in the upper Mountain Fork River populations (MF, BE, BC) of *P. pantherina*. *Percina maculata* is a widespread species that is sister to *P. pantherina* (Near and McEachran 2002), known from the mainstem Little River and the lower Glover River (James et al. 1991), but annual surveys indicate it is rare and not recorded in the upper Mountain Fork River (D. Fenner, pers. comm.). It is likely that hybridization and backcrossing to *P. pantherina* occurred prior to damming of the river, although additional testing would be needed to validate this hypothesis.

The results of this analysis exemplify the conclusion from theory that a significant signal of IBD does not necessarily imply migration-drift equilibrium (Hutchison and

Templeton 1999). The populations of *P. pantherina* clearly are not in equilibrium because of recently imposed, effectively complete barriers to dispersal and associated declines in population sizes. Migration-drift imbalance despite indications of IBD from measures of genetic distance can be a transient state between different equilibria (Hutchison and Templeton 1999). For *P. pantherina*, the imbalance between migration and genetic drift likely are so recent that the molecular signals of historical IBD have not been erased in the transition to a new equilibrium. In this transition, populations are diverging as a result of the shift in balance between gene flow (effectively zero) and genetic drift.

Conservation implications—Studies with salmonids document the expectation for stream fishes that the likelihood of extirpation after damming is a positive function of stream size (Morita and Yamamoto 2002). Correspondingly, *P. pantherina* appears to have been extirpated sometime in the past two decades from the smallest of the streams known to support the species (Robinson Fork; D. Fenner, pers. comm). Additionally, the species is near extinction in the second-smallest such stream (Cossatot River), where the coalescence estimate of N_e is 5 (95% HPD = 0-50) and the species sometimes goes undetected during annual surveys (D. Fenner, pers. comm). The estimated N_e is similarly small in a Mountain Fork River tributary (Buffalo Creek; $N_e = 6$, HPD = 0-112) separated from the remainder of the Mountain Fork system by a reservoir.

The molecular estimates of population sizes, together with severe barriers to gene flow indicate that, without human intervention, *P. pantherina* is one of those species that are among the “‘living dead,’ committed to extinction because extinction is the

equilibrium toward which . . . [the metapopulation is] moving in the present fragmented landscape” (Hanski et al. 1996:527). Those authors emphasized the need in such instances to reverse the process of habitat loss and fragmentation. For *P. pantherina* this entails removal of dams. Fish ladders or other devices aimed at circumventing dams would be of no value to a fish, like *P. pantherina*, that is unlikely to disperse through a reservoir.

Dam removal is straightforward and frequently considered in stream restoration literature (Bednarek 2001; Palmer et al. 2005), but it often is not feasible because of human societal demands (Blanchet et al. 2010). An alternative is to mitigate the negative genetic effects of dams by artificial gene flow (e.g., transfer of individuals) among populations (Meffe and Vrijenhoek 1988) and such a program is being considered by the federal agencies charged with conserving *P. pantherina* (D. Fenner, pers. comm.).

Efforts to conserve *P. pantherina* should include local habitat modifications aimed at increasing effective population sizes. The species performs rather weakly in tests of swimming ability, and water-flow velocities in road culverts often exceed levels permitting easy upstream passage (Toepfer et al. 1999). A mark-resighting study (Schaefer et al. 2003) found no evidence of upstream dispersal through such culverts and it was suggested that managers should both minimize the number of road crossings (e.g., culverts), and that required crossings be built to facilitate fish passage. Those authors also emphasized that a limiting factor for the species might be the accessibility of deeper pools that serve as thermal refuges during the summer. Thus, managers might consider habitat modifications with this requirement in mind.

A population viability analysis for *P. pantherina* suggested that, with various assumptions (e.g., the magnitude and frequency of losses due to drought), there was a 6% chance of extinction within 50 years (Williams et al. 1999). This was based on demographic simulations starting with estimated numbers of individuals in each stream supporting the species. The population size estimates probably were overestimated because the need for deeper thermal refuges was not included in evaluating the amount of suitable habitat (Schaefer et al. 2003). The likelihood of extinction might be considerably higher with more exact estimates of population size. The model of viability was most sensitive to catastrophes and the second-most important factor was level of migration (zero, 1×10^{-5} , or 1×10^{-4}) among populations (Williams et al. 1999).

The population viability analysis noted above for *P. pantherina* did not consider genetic factors in estimating likelihood of extinction. It has been argued that the most immediate threats to population viability are demographic rather than genetic factors (Lande 1988). However, genetic metrics indicative of a potential for high levels of inbreeding typically occur before demographic extinction (Spielman et al. 2004) and demographic and genetic factors in declining populations are expected to show negative feedback loops leading to extinction (Gilpin and Soulé 1986). With demographic factors in mind, any program of artificial transport among populations should include adaptive management plans aimed at supplementing populations showing evidence of significant decline.

References

- Allendorf FW, Luikart G (2007) Conservation and the genetics of populations.
Blackwell, Malden
- Allendorf, F. W., N. Ryman, and F. Utter. 1987. Genetics and fishery management: past, present, and future. In: Ryman N, Utter F (eds) Population genetics and fishery management. University of Washington Press, Seattle, pp1–20
- Aló D, Turner TF (2005) Effects of habitat fragmentation on effective population size in the endangered Rio Grande silvery minnow. *Conservation Biology* 19, 1138-1148
- Bandelt H-J, Forster P, Röhl A (1999) Median-joining networks for inferring intraspecific phylogenies. *Molecular biology and evolution* 16, 37-48
- Beaumont MA (1999) Detecting population expansion and decline using microsatellites. *Genetics* 153, 2013-2029
- Beaumont MA (2003) Estimation of population growth or decline in genetically monitored populations. *Genetics* 164, 1139-1160
- Bednarek AT (2001) Undamming rivers: a review of the ecological impacts of dam removal. *Environmental Management* 27, 803-814
- Blanchet S, Rey O, Ethenne R, Lek S, Loot, G (2010) Species-specific responses to landscape fragmentation: implications for management strategies. *Evolutionary Applications* 3, 291–304
- Cornuet JM, Luikart G (1996) Description and power analysis of two tests for detecting recent population bottlenecks from allele frequency data. *Genetics* 144, 2001-2014

- Echelle AF, Echelle AA, Williams LR, Toepfer CS, Fisher WL (1999) Allozyme perspective on genetic variation in a threatened percid fish, the leopard darter (*Percina pantherina*). *American Midland Naturalist*, 142, 393-400
- Eley RL, Randolph JC, Miller RJ (1975) Current status of the leopard darter, *Percina pantherina*. *The Southwestern Naturalist* 343-354
- Eliades N, Eliades D (2009) Haplotype Analysis: software for analysis of haplotype data. Forest Goettingen (Germany): Genetics and Forest Tree Breeding, Georg-August University Goettingen
- Excoffier L, Lischer HE (2010) Arlequin suite ver 3.5: a new series of programs to perform population genetics analyses under Linux and Windows. *Molecular ecology resources* 10, 564-567
- Fagan WF (2002) Connectivity, fragmentation, and extinction risk in dendritic metapopulations. *Ecology* 83, 3243-3249
- Fu YX (1996) New statistical tests of neutrality for DNA samples from a population. *Genetics*, 143, 557-570
- Fu YX, Li WH (1993) Statistical tests of neutrality of mutations. *Genetics*, 133, 693-709.
- Garza J, Williamson E (2001) Detection of reduction in population size using data from microsatellite loci. *Molecular ecology*, 10, 305-318
- Gilpin ME, Soule ME (1986) Minimum viable populations: processes of species extinctions. Pages 19-34 in M. E. Soule, editor. *Conservation biology. The science of scarcity and diversity*. Sinauer, Sunderland

- Girod C, Vitalis R, Leblois R, Fréville H (2011) Inferring population decline and expansion from microsatellite data: a simulation-based evaluation of the Msvvar method. *Genetics* 188, 165-179
- Goudet J (1995) FSTAT (Version 1.2): A computer program to calculate F-statistics. *J Heredity* 86, 485-486
- Guo SW, Thompson EA (1992) Performing the exact test of Hardy-Weinberg proportion for multiple alleles. *Biometrics* 361-372
- Hedrick PW (2011) *Genetics of populations*. Jones & Bartlett Publishers.
- Hanski I, Moilanen A, Gyllenberg M (1996) Minimum viable metapopulation size. *The American Naturalist* 147, 527-541
- Helfman G (2007) *Fish conservation: a guide to understanding and restoring global aquatic biodiversity and fishery resources*. Island Press, Washington
- Hubisz MJ, Falush D, Stephens M, Pritchard JK (2009) Inferring weak population structure with the assistance of sample group information. *Molecular Ecology Resources* 9, 1322-1332
- Hutchison D W, Templeton AR (1999) Correlation of pairwise genetic and geographic distance measures: inferring the relative influences of gene flow and drift on the distribution of genetic variability. *Evolution* 53, 1898-1914
- James PW, Collins KD (1993) *Leopard Darter, *Percina pantherina* (Moore and Reeves): Revised Recovery Plan (Original Approved: September 20, 1984)*. US Fish and Wildlife Service
- James PW, Maughan OE (1989) Spawning behavior and habitat of the threatened leopard darter, *percina-pantherina*. *Southwestern Naturalist* 34, 298-301

- James PW, Maughan OE, Zale A (1991) Life history of the leopard darter *Percina pantherina* in Glover River, Oklahoma. *American Midland Naturalist* 125, 173-179
- Jones RN, Orth DJ, Maughan OE (1984) Abundance and preferred habitat of the leopard darter, *Percina pantherina*, in Glover Creek, Oklahoma. *Copeia* 1984, 378-384
- Kalinowski ST (2005) HP-Rare 1.0: a computer program for performing rarefaction on measures of allelic richness. *Molecular Ecology Notes* 5, 187-189
- Luttrell GR, Echelle AA, Fisher WL, Eisenhour DJ (1999) Declining status of two species of the *Macrhybopsis aestivalis* complex (Teleostei: Cyprinidae) in the Arkansas River Basin and related effects of reservoirs as barriers to dispersal. *Copeia* 1999, 981-989
- Lande R (1988) Genetics and demography in biological conservation. *Science* 241, 1455-1460
- Laroche J, Durand JD (2004) Genetic structure of fragmented populations of a threatened endemic percoid of the Rhone river: *Zingel asper*. *Heredity* 92, 329-334
- Meffe GK, Vrijenhoek RC (1988) Conservation genetics in the management of desert fishes. *Conservation Biology* 2, 157-169
- Morita, K., and A. Yokota. 2002. Population viability of stream-resident salmonids after habitat fragmentation: a case study with white-spotted charr (*Salvelinus leucomaenis*) by an individual based model. *Ecological Modeling* 155, 85–94
- Morita K, Yamamoto S (2002) Effects of habitat fragmentation by damming on the persistence of stream-dwelling charr populations. *Conservation Biology* 16, 1318–1323

- Near TJ, McEachran J (2002) Phylogenetic relationships of *Percina* (Percidae: Etheostomatinae). *Copeia*, 2002, 1-14
- Near TJ, Porterfield JC, Page LM, McEachran J (2000) Evolution of cytochrome b and the molecular systematics of Ammocrypta (Percidae: Etheostomatinae). *Copeia* 2000, 701-711
- Nei M (1987) Molecular evolutionary genetics. Columbia University Press, New York
- Neraas LP, Spruell P (2001) Fragmentation of riverine systems: the genetic effects of dams on bull trout (*Salvelinus confluentus*) in the Clark Fork River system. *Molecular Ecology* 10, 1153–1164
- Palmer MA, Bernhardt ES, Allan JD, Lake PS, Alexander G, Brooks S, Clayton S, Dahm CN, Follstad Shah J, Galat DL, Loss SG, Goodwin P, Hart DD, Hassett B, Jenkinson R, Kondolf GM, Lave R, Meyer JL, O'Donnell TK, Pagano L, Sudduth E (2005) Standards for ecologically successful river restoration. *Journal of Applied Ecology* 42:208–217
- Pritchard JK, Stephens M, Donnelly P (2000) Inference of population structure using multilocus genotype data. *Genetics* 155, 945-959
- Raeymaekers JAM, Maes GE, Geldof S, Hontis I, Nackaerts K, Volckaert FAM (2008) Modeling genetic connectivity in sticklebacks as a guideline for river restoration. *Evolutionary Applications* 1, 475-488
- Raymond M, Rousset F (2004) GENEPOP version 3.4. Population genetics software for exact tests and ecumenicism Montpellier, France, Laboratoire de Genetique et Environment
- Rice WR (1989) Analyzing tables of statistical tests. *Evolution* 43, 223-225

- Rousset F (2008) genepop'007: a complete re-implementation of the Genepop software for Windows and Linux. *Molecular Ecology Resources* 8, 103-106
- Rutherford DA, Echelle AA, Maughan OE (1992) Drainage-wide effects of timber harvesting on the structure of stream fish assemblages in southeastern Oklahoma. *Transactions of the American Fisheries Society* 121, 716-728
- Schaefer JF, Marsh-Matthews E, Spooner DE, Gido KB, Matthews WJ (2003) Effects of barriers and thermal refugia on local movements of the threatened leopard darter, *Percina pantherina*. *Environmental Biology of Fishes* 66, 391-400
- Schwemm MR, Echelle AA (2013) Development and characterization of eight polymorphic tetra-nucleotide microsatellite markers for the threatened leopard darter (*Percina pantherina*). *Conservation Genetics Resources* 5, 73-75
- Slatkin M (1993) Isolation by distance in equilibrium and non-equilibrium populations. *Evolution* 47, 264-279
- Spielman D, Brook BW, Frankham R (2004) Most species are not driven to extinction before genetic factors impact them. *Proceedings of the National Academy of Science USA* 101, 15261-15264
- Tajima F (1989) Statistical method for testing the neutral mutation hypothesis by DNA polymorphism. *Genetics* 123, 585-595
- Tajima F (1993) Unbiased estimation of evolutionary distance between nucleotide sequences. *Molecular biology and evolution* 10, 677-688
- Tallmon DA, Koyuk A, Luikart G, Beaumont MA (2008) COMPUTER PROGRAMS: onesamp: a program to estimate effective population size using approximate Bayesian computation. *Molecular Ecology Resources* 8, 299-301

- Tamura K, Peterson D, Peterson N, Stecher G, Nei M, Kumar S (2011) MEGA5: molecular evolutionary genetics analysis using maximum likelihood, evolutionary distance, and maximum parsimony methods. *Molecular biology and evolution* 28, 2731-2739
- Toepfer CS, Fisher WL, Haubelt JA (1999) Swimming performance of the threatened leopard darter in relation to road culverts. *Transactions of the American Fisheries Society* 128, 155–161
- van Oosterhout C, Hutchinson WF, Wills DP, Shipley P (2004) Micro-checker: software for identifying and correcting genotyping errors in microsatellite data. *Molecular Ecology Notes* 4, 535-538
- Vucetich JA, Waite TA (2000) Is one migrant per generation sufficient for the genetic management of fluctuating populations? *Animal Conservation* 3, 261-266
- USFWS (1978) Final threatened status and critical habitat for the leopard darter. U.S. Federal Register 43:3711-3716
- Waples RS, Do C (2008) LDNE: a program for estimating effective population size from data on linkage disequilibrium. *Molecular Ecology Resources* 8, 753-756
- Waples RS, Do C (2010) Linkage disequilibrium estimates of contemporary Ne using highly variable genetic markers: a largely untapped resource for applied conservation and evolution. *Evolutionary Applications* 3, 244-262
- Williams LR, Echelle AA, Toepfer CS, Williams MG, Fisher WL (1999) Simulation modeling of population viability for the leopard darter (Percidae: *Percina pantherina*). *The Southwestern Naturalist* 44, 470-477

Wofford JEB, Gresswell RE, Banks MA (2005) Influence of barriers to movement on within-watershed genetic variation of coastal cutthroat trout. *Ecological Applications* 15, 628-637

Yamamoto S, Morita K, Koizumi I, Maekawa K (2004) Genetic differentiation of white-spotted charr (*Salvelinus leucomaenis*) populations after habitat fragmentation: Spatial-temporal changes in gene frequencies. *Conservation Genetics* 5, 529-538

Zale AV, Leon SC, Lechner M, Maughan OE, Ferguson MT, Odonnell S, James B, James PW (1994) Distribution of the threatened leopard darter, *Percina pantherina* (Osteichthyes, Percidae). *Southwestern Naturalist* 39, 11-20

Table 1 MtDNA (*cyt b*) haplotypes of *Percina pantherina* sampled from seven collection sites (populations: LR, GR, MF, BC, BC and CR).

Haplotype	LR	GR	MF	BC	BE	CR	Total
A						14	14
B			9	7	13		29
C			1				1
D			3	6	3		12
E					1		1
F			1	1	2		4
G	1						1
H	5		4	3		3	15
I		5					5
J	2						2
K	9	14					23
L			2	1	2		5
Total	17	19	20	18	21	17	112

Table 2 Summary statistics for mtDNA variation in six populations of *P. pantherina*. N = number of individuals, H = number of haplotypes, H_R = haplotype richness, H_P = number of private haplotypes, h = haplotype diversity (SD_h = standard deviation), π = nucleotide diversity (SD_π = standard deviation), F = inbreeding coefficient. Asterisks signify populations from the Mountain Fork River carrying a heterospecific haplotype (see text).

Population	N	H	H_R	H_P	h	SD_h	π	SD_π
LR	17	4	3.000	2	0.654	0.089	0.00099	0.00021
GR	19	2	1.000	1	0.409	0.100	0.00050	0.00054
MF*	20	6	4.683	1	0.758	0.077	0.01157	0.00618
BC*	17	4	3.000	0	0.713	0.064	0.00232	0.00154
BE*	21	5	3.749	1	0.605	0.111	0.01075	0.00576
CR	17	2	1.000	1	0.309	0.122	0.00184	0.00130
Mean	18.5	3.8	2.739	1.0	0.575	0.094	0.00466	0.00259

Table 3 AMOVA results for mtDNA and eight microsatellite loci in *P. pantherina*.

Level	<i>F</i> -statistic	<i>P</i>
mtDNA		
Among populations within tributaries	Φ_{SC} 0.029	0.481
Among tributaries	Φ_{CT} 0.305	0.043
Within populations	$1 - (\bar{H}_S/H_T)$ 0.675	
Microsatellites		
Among populations within tributaries	F_{SC} 0.005	< 0.001
Among tributaries	F_{CT} 0.108	0.002
Within populations	$1 - (\bar{H}_S/H_T)$ 0.887	

Table 4 Pairwise Φ_{ST} (below) and probabilities (above) for mtDNA among seven populations of *P. pantherina*. Bold font = significant with the Bonferroni correction (tablewide $\alpha = 0.05$).

Population	LR	GR	MF	BC	BE	CR
LR	-	<0.0001	<0.0001	<0.0001	<0.0001	<0.0001
GR	0.2744	-	<0.0001	<0.0001	<0.0001	<0.0001
MF	0.1498	0.2281	-	0.3604	0.3153	<0.0001
BC	0.3495	0.5544	0.0212	-	0.3153	<0.0001
BE	0.2052	0.2619	0.0000	0.0378	-	<0.0001
CR	0.6947	0.8007	0.3566	0.6398	0.3905	-

Table 5 Mean indexes of variation across 8 microsatellite DNA loci in seven population of *P.pantherina*. N = sample size, A = number of alleles, A_R = allele richness, A_P = number of private alleles, H_O = observed heterozygosity, H_E = expected heterozygosity, F = inbreeding coefficient.

Population	N	A	A_R	A_P	H_O	H_E	F
LR1	26.88	6.25	5.74	0.12	0.577	0.591	0.007
LR2	18.25	5.75	5.71	0.02	0.572	0.619	0.074
GR	20.25	6.63	6.29	1.04	0.643	0.607	-0.011
MF	23.25	7.13	6.60	0.33	0.563	0.574	-0.002
BC	17.75	5.50	5.44	0.25	0.520	0.531	0.006
BE	34.75	7.00	6.15	0.15	0.577	0.560	-0.046
CR	17.50	3.75	3.74	0.38	0.469	0.448	-0.063
mean	22.66	6.00	5.67	0.33	0.560	0.561	-0.006

Table 6 Pairwise F_{ST} (below) and probabilities (above) based on eight microsatellite loci. Bold font = significant with the Bonferroni correction (tablewide $\alpha = 0.05$).

Population	LR1	LR2	GR	MF	BC	BE	CR
LR1	-	0.5586	<0.0001	<0.0001	<0.0001	<0.0001	<0.0001
LR2	0.0000	-	<0.0001	<0.0001	<0.0001	<0.0001	<0.0001
GR	0.0467	0.0406	-	<0.0001	<0.0001	<0.0001	<0.0001
MF	0.0678	0.0852	0.1016	-	0.1171	0.2703	<0.0001
BC	0.0929	0.1080	0.1167	0.0067	-	0.0090	<0.0001
BE	0.0816	0.0998	0.1168	0.0014	0.0171	-	<0.0001
CR	0.1767	0.1968	0.1543	0.1635	0.1595	0.1791	-

Table 7 Effective population size estimated from microsatellite DNA variation by three different methods for five populations of *P. pantherina*. Little River (LR1, LR2) and two Mountain Fork (MF, BE) sites were combined for these analyses. Results show are means and 95% support limits for effective population sizes and time since the beginning of the decline phase.

Site	MSVAR			LDNe	OneSAMP
	Ancestral N_e	Decline phase	Current N_e	Current N_e	Current N_e
LR1/LR2	194,985 (39,811 - 794,328)	120 yrs (21 - 977)	39 (7 - 316)	103 (48 - 2191)	81 (60 - 158)
GR	251,189 (60,256 - 1,122,018)	80 yrs (8 - 759)	15 (2 - 156)	34 (18 - 115)	40 (29 - 83)
MF/BE	275,423 (63,095 - 1,047,128)	186 yrs (40 - 631)	69 (17 - 417)	850 (148- ∞)	76 (54 - 149)
BC	190,547 (31,622 - 851,138)	32 yrs (4 - 501)	6 (0-112)	44 (16.7- ∞)	25 (19 - 55)
CR	125,893 (25,119 - 630,957)	50 yrs (8 - 562)	5 (0 - 50)	41 (10.2 - ∞)	13 (9 - 22)
Means	207,607 43,980 - 889,114	94 16 - 686	27 5 - 210	214 48 - ∞	47 34 - 93

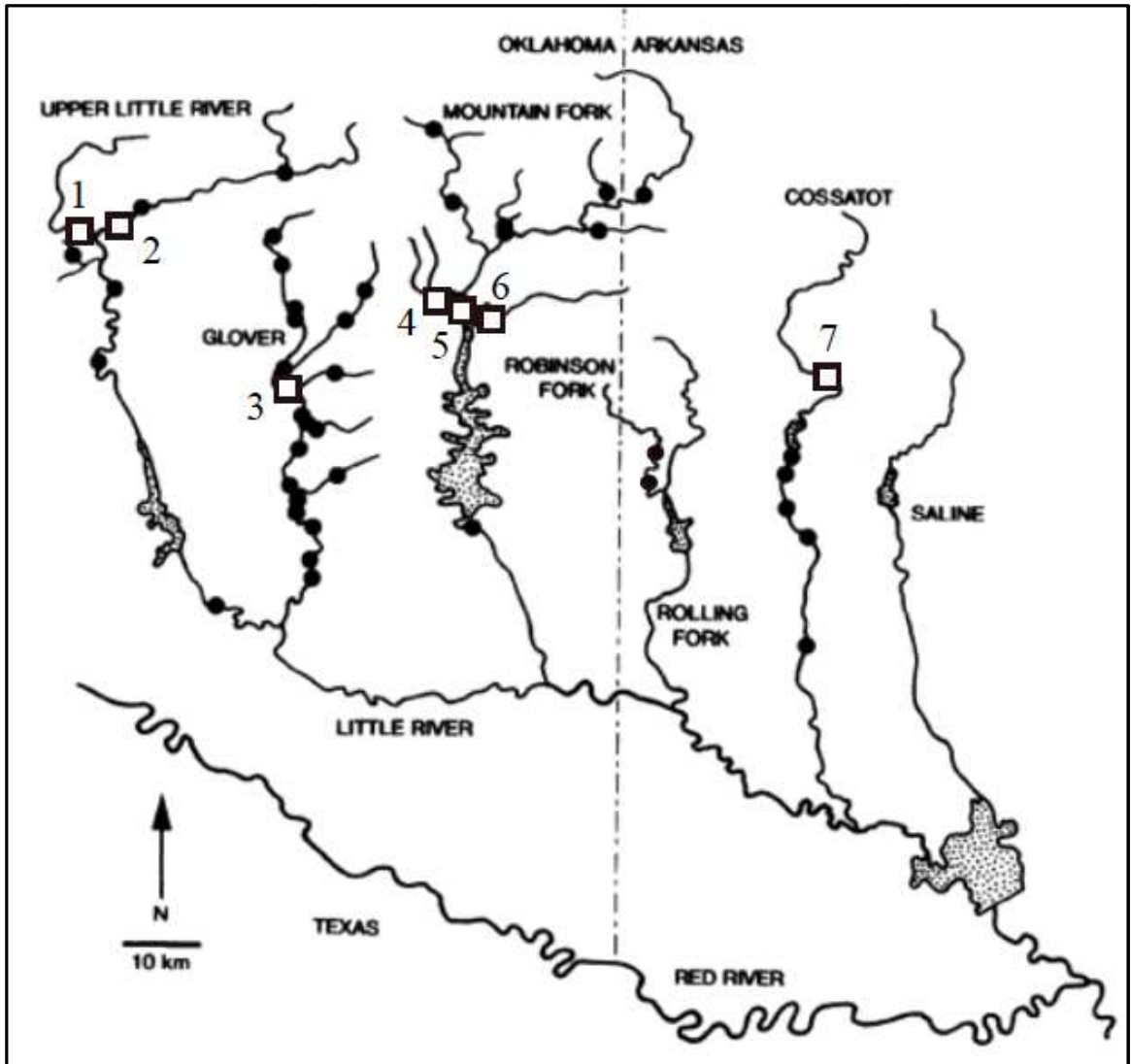

Figure 1 Sample sites (open squares) and historical localities (solid circles) for *Percina pantherina*. Figure modified from Zale et al. (1994). Sites: (1) LR1, 34°31'48.00"N, 95° 0'55.00"W; (2) LR2, 34°24'41.00"N, 95° 9'59.00"W; (3) GR, 34° 5'50.93"N, 94°54'10.49"W; (4) BE, 34°29'24.00" N, 94°41'02.00"W; (5) MF, 34°24'13"N, 94°40'42.00" W; (6) BC, 34°22'9.10"N, 94°37'22.76"W; (7) CR, 34°17'42.69"N, 94°10'22.41"W.

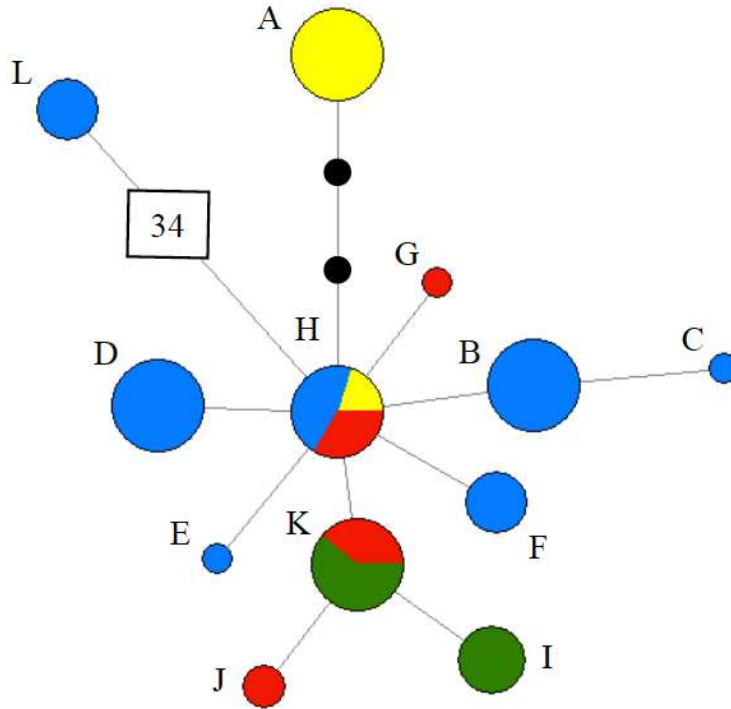

Figure 2 Haplotype network of mtDNA (*cytb*) sequences for populations of *P. pantherina* from four Little River tributaries. Haplotype designations correspond to Table 1. Colors represent tributaries (red = LR, green = GR, blue = MF, yellow = CR, black = unsampled haplotype) and size is proportional to frequency. Haplotype L is 34 substitutions from the central haplotype.

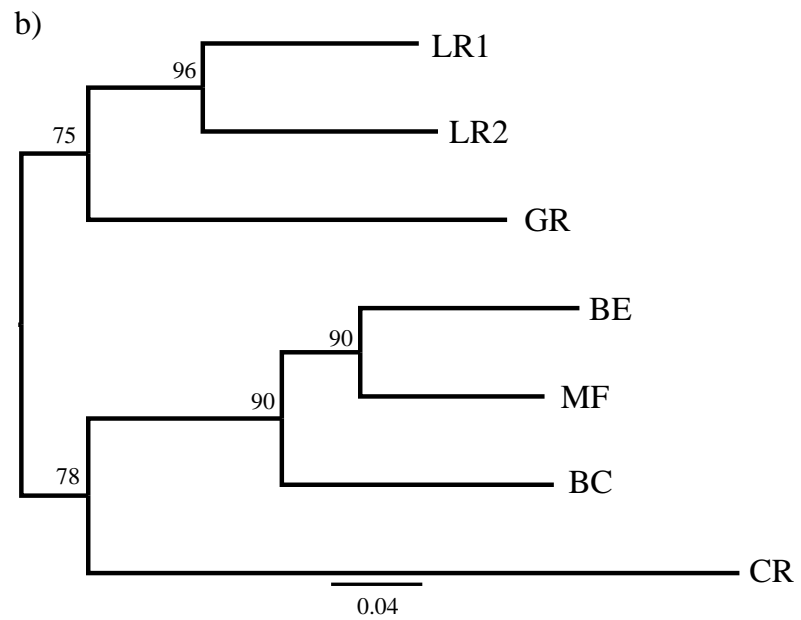
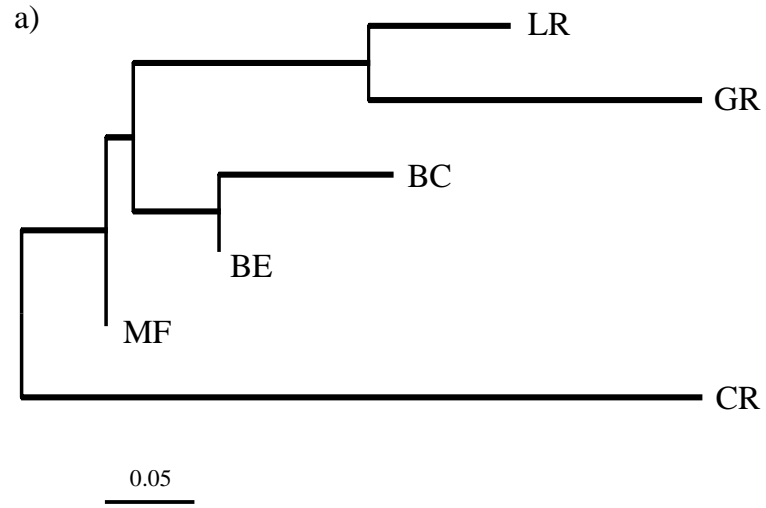

Figure 3 Neighbor-joining trees for *Percina pantherina* computed from genetic distances for mtDNA (Φ_{ST} distance) and eight microsatellite loci (Cavalli-Sforza chord distance, bootstrapped over loci, 1000 replicates).

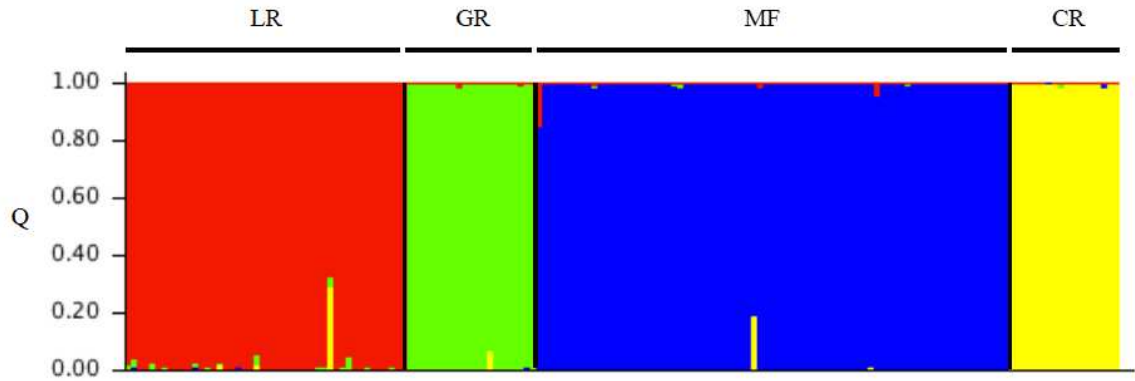

Figure 4 Results of STRUCTURE test for recent migrants of *Percina pantherina* among the four tributaries of the Little River system. Individuals sampled are arranged in tributary order from west to east. Little River sites (LR1, LR2) and Mountain Fork sites (MF, BC, BE) were pooled as LR or MF for this analysis.

Appendix A Marker characteristics for 10 microsatellite loci. Abbreviations include the sample size (N), number of alleles by count (A) and rarefaction (A_R), observed heterozygosity (H_O), expected heterozygosity (H_E), inbreeding coefficient (F), and Hardy-Weinberg probability (P_{HW}). (populations: LR, GR, MF, BC, BC and CR).

<i>Locus: A5</i>								
	LR1	LR2	GR	MF	BC	BE	CR	mean
N	27	19	20	24	18	35	17	22.857
A	1	1	2	2	1	1	2	1.429
A_R	1.000	1.000	1.998	1.919	1.000	1.000	2.000	1.417
H_O	0.000	0.000	0.050	0.083	0.000	0.000	0.059	0.027
H_E	0.000	0.000	0.139	0.080	0.000	0.000	0.057	0.039
F	-	-	0.640	-0.043	-	-	-0.030	0.189
P_{HW}	-	-	0.004	0.831	-	-	0.901	0.579

locus: A103

	LR1	LR2	GR	MF	BC	BE	CR	mean
N	27	18	20	24	17	35	18	22.714
A	4	5	4	7	3	4	2	4.143
A_R	3.821	4.944	3.962	5.732	3.000	3.161	2.000	3.803
H_O	0.481	0.500	0.650	0.375	0.118	0.200	0.222	0.364
H_E	0.555	0.651	0.489	0.332	0.112	0.186	0.198	0.360
F	0.132	0.232	-0.330	-0.128	-0.046	-0.077	-0.125	-0.049

P_{HW} 0.962 0.253 0.591 1.000 0.996 0.999 0.596 0.771

locus: B4

	LR1	LR2	GR	MF	BC	BE	CR	mean
N	27	19	20	24	18	33	18	22.714
A	5	4	5	7	6	8	5	5.714
A_R	4.625	4	4.85	6.893	5.889	7.198	4.944	5.486
H_O	0.741	0.579	0.850	0.917	0.611	0.818	0.667	0.740
H_E	0.723	0.643	0.708	0.803	0.753	0.760	0.642	0.719
F	-0.025	0.099	-0.201	-0.142	0.189	-0.076	-0.038	-0.028
P_{HW}	0.939	0.184	0.616	0.013	0.649	0.935	0.996	0.619

locus: C105

	LR1	LR2	GR	MF	BC	BE	CR	mean
N	26	18	20	23	17	35	18	22.429
A	5	5	7	11	7	10	5	7.143
A_R	4.538	4.998	6.7	10.356	7.000	8.831	4.995	6.774
H_O	0.577	0.556	0.750	0.826	0.765	0.886	0.722	0.726
H_E	0.635	0.741	0.761	0.855	0.772	0.828	0.637	0.747
F	0.092	0.250	0.015	0.034	0.009	-0.070	-0.133	0.028
P_{HW}	0.930	0.488	0.330	0.841	0.188	0.849	0.980	0.658

locus: B6

	LR1	LR2	GR	MF	BC	BE	CR	mean
<i>N</i>	27	19	21	23	18	35	17	22.857
<i>A</i>	8	7	12	7	8	8	5	7.857
<i>A_R</i>	7.444	6.886	11.166	6.478	7.889	6.450	5.000	7.330
<i>H_O</i>	0.778	0.842	0.857	0.696	1.000	0.886	0.529	0.798
<i>H_E</i>	0.800	0.809	0.845	0.796	0.841	0.798	0.471	0.766
<i>F</i>	0.027	-0.041	-0.015	0.126	-0.189	-0.110	-0.125	-0.047
<i>P_{HW}</i>	0.292	0.101	0.151	0.483	0.445	0.608	0.672	0.393

locus: B102

	LR1	LR2	GR	MF	BC	BE	CR	mean
<i>N</i>	27	18	21	23	18	35	17	22.714
<i>A</i>	10	9	11	12	7	12	5	9.429
<i>A_R</i>	8.987	8.884	9.982	11.046	6.944	10.492	5.000	8.762
<i>H_O</i>	0.926	0.889	0.762	0.913	0.722	0.829	0.647	0.813
<i>H_E</i>	0.829	0.799	0.796	0.873	0.826	0.868	0.680	0.810
<i>F</i>	-0.117	-0.112	0.043	-0.045	0.125	0.045	0.048	-0.002
<i>P_{HW}</i>	0.580	0.047	0.620	0.530	0.091	0.909	0.720	0.500

locus: B103

	LR1	LR2	GR	MF	BC	BE	CR	mean
<i>N</i>	27	18	19	22	18	35	17	22.286
<i>A</i>	2	3	3	1	2	2	2	2.143

A_R	2.000	2.998	2.991	1.000	1.998	1.985	2.000	2.139
H_O	0.370	0.444	0.368	0.000	0.111	0.171	0.235	0.243
H_E	0.302	0.426	0.314	0.000	0.105	0.157	0.208	0.216
F	-0.227	-0.043	-0.172	-	-0.059	-0.094	-0.133	-0.121
P_{HW}	0.238	0.861	0.809	-	0.803	0.579	0.582	0.645

locus: B105

	LR1	LR2	GR	MF	BC	BE	CR	mean
N	27	17	21	23	18	35	18	22.714
A	15	12	9	10	10	11	4	10.143
A_R	13.469	12.000	8.706	9.382	9.832	10.101	3.998	9.641
H_O	0.741	0.765	0.857	0.696	0.833	0.829	0.667	0.770
H_E	0.887	0.881	0.805	0.852	0.843	0.880	0.690	0.834
F	0.165	0.132	-0.065	0.183	0.011	0.059	0.034	0.074
P_{HW}	0.037	0.116	0.043	0.729	0.747	0.347	0.054	0.296

CHAPTER IV

LIFE-HISTORY DIFFERENCES PREDICT PATTERNS OF GENETIC VARIATION IN TWO CO-OCCURRING DARTERS, *PERCINA PANTHERINA* AND *P. CAPRODES*

The importance of life-history strategies on patterns of genetic variation is central to understanding evolutionary change and predicting population response to environmental challenges. I used mtDNA (cytb) variation to compare the genetic structure of two syntopic darters with contrasting life histories, *Percina pantherina*, a federally threatened species endemic to the Little River in the Ouachita Highlands of Arkansas and Oklahoma, USA, and the wide ranging *P. caprodes*. *Percina caprodes* has a larger body size, greater fecundity, and smaller eggs than *P. pantherina*. Conforming to expectations from past studies on darters, it showed evidence of much greater gene flow, effectively panmictic prior to the presence of large impassable dams. In contrast, *P. pantherina* showed strong evidence of geographic structure ($F_{ST} = 0.36$) and isolation by distance. Other life history factors also contribute to greater gene flow in *P. caprodes*, including the following: (1) broader habitat requirements, allowing occupation of a broader range of habitats, including reservoirs, whereas *P. pantherina* is restricted to streams, and (2) the capacity for multiyear spawning by individuals, allowing more time to disperse than in individuals of *P. pantherina*, which spawn only in their second year. Overall, these results confirm the importance of considering species-specific life-history traits when evaluating evolutionary change and the loss of evolutionary potential in modified environments.

Introduction

Understanding the mechanisms influencing population genetic structure is central to evolutionary and conservation biology. Patterns of genetic variation can demonstrate how evolutionary forces affect the potential for local adaptation and the cohesiveness of a species. The goals of most population-level studies are to evaluate the genetic effects of geographic barriers, the most ubiquitous factor generating concordant genetic patterns among species (Avice 1987). Such concordance implicates common biogeographic factors for different taxa (Avice 1992, 2009). Superimposed on such factors, however, are intrinsic life-history attributes affecting levels of gene flow and effective population size, producing divergent evolutionary trajectories for co-occurring species (Waples 1987, Frankham 1996, Tibbets and Dowling 1996, Turner et al. 1996, Turner and Trexler 1998). Population genetic theory for neutral markers explains genetic variation through the relative strengths of mutation, migration, and genetic drift (Kimura 1984). Accordingly, traits associated with dispersal and abundance should contribute toward explaining genetic patterns across taxa.

Several recent studies have specifically identified life-history differences as mediators of genetic structure over a diverse range of taxa, including terrestrial mammals (Ehrich et al. 2001) and birds (McDonald et al. 1999), as well as marine (Portnoy et al. 2010), anadromous and lacustrine fishes (Waples 1987; Harris et al. 2012, Östergren and Nilsson 2012), and stream-dwelling fishes (Turner et al. 1996; Turner and Trexler 1998). In fishes, such studies generally show that gene flow is positively correlated with body size (but see Blanchet et al. 2010) and fecundity and negatively correlated with egg size. However, overall patterns of geographic variation can be strongly influenced by historical

biogeographic events, demonstrating that associations between life-history traits and gene flow must be interpreted in light of biogeographic history (Turner and Trexler 1998).

The Little River system of the Ouachita Highlands in southeastern Oklahoma and southwestern Arkansas presents an opportunity to evaluate the relationship between genetic variation and life-history in a relatively simple system without the added complexity of large-scale biogeographic history. In this paper I examine the relationship between life-history traits and genetic structure in two co-occurring darters, the leopard darter *Percina pantherina*, which is endemic to the Little River, and the common logperch, *P. caprodes*, a widely distributed species across central United States. The results corroborate the profound effect of life history on gene flow, even in small systems.

Materials and Methods

Sampling and DNA extraction—*P. pantherina* and *P. caprodes* were collected from upland portions of four tributaries of the Little River system: upper Little River (LR), Glover River (GR), Buffalo Creek (BC) and Cossatot River (CR)(Fig. 1). Fish were individually collected by hand-net, fin clips (2 x 2 mm) removed and preserved in 95% EtOH in the field. Individuals of *P. caprodes* were retained for vouchers, while *P. pantherina* were returned to site of capture due to their federally threatened status (USFWS 43 FR 3715, 1978).

Genomic DNA was extracted using DNeasy kits (Qiagen, Valencia, CA) and sequenced for either NADH dehydrogenase subunit 2 (ND2; 1047 base pairs) or cytochrome *b* (*cyt b*; 843 bp), depending on the species (ND2 for *P. caprodes*; *cyt b* for

P. pantherina). Haplotype sequences for ND2 gene were provided by D. T. Lynch (Lynch 2010). Sequences were amplified for 25-30 cycles using the 2X Qiagen Multiplex PCR Mastermix with an initial activation step of 15 min at 95° C and final denaturation step of 10 min at 72° C. Specific primers and thermal profiles for the polymerase chain reaction (PCR) are given in Appendix 1. PCR products were cleaned for sequencing with either the Wizard SV PCR cleanup kit (Promega, Madison, WI) or EXOSAP (USB Corp., Cleveland, OH) with the following temperature profile (modified from the manufacturer): 37° C for 30 min, 80° C for 15 min and 12° C for 5 min. DNA was sequenced with an ABI model 3130 sequencer (Applied Biosystems, Foster City, CA). Sequences were edited and aligned manually using Geneious ver. 4.7 (Biomatters Ltd., New Zealand).

Analyses of genetic variation—Patterns of nucleotide polymorphism within species were first evaluated for neutrality at constant population size using neutrality tests in DNASP 5.10 (Librado and Rozas 2009) of Tajima's D (Tajima 1989), and Fu and Li's D and F (Fu and Li 1993, 1996). Sequences were summarized for number of haplotypes and haplotype richness (H_R) using HAPLOTYPE ANALYSIS 1.04 (Eliades and Eliades 2009). Divergence among haplotypes was evaluated by constructing haplotype networks using the median-joining method in NETWORK 4.5.1.6 (Bandelt et al. 1999). DNASP 5.10 was used to estimate unbiased gene diversity (h ; Nei 1987), mean pairwise differences per site (k) and the per-site population diversity index θ_S , the mutation-scaled effective population size ($\theta_S = 2N_e\mu$; Watterson, 1975). Differences among populations were analyzed by the fixation index Φ_{ST} in ARLEQUIN v. 3.5.1.3 (Excoffier and Lischer 2010),

an F_{ST} analog incorporating nucleotide differences, using the Tamura-Nei model of nucleotide evolution, selected by AICc in MEGA 5.2 (Tamura et al. 2011). Global and pairwise estimates of F_{ST} were tested for significance using 10,000 permutations.

Pairwise F_{ST} values were converted to indirect estimates of gene flow \hat{M} ($= Nm$) using the relationship $\hat{M} = ((1/ \Phi_{ST})^{-1})^{-2}$ of Slatkin (1993), as modified for haploid data from Wright's (1951) island model for diploid data. Negative values of F_{ST} were assumed to be zero, with \hat{M} approaching ∞ . Mantel (1967) tests of isolation-by-distance (IBD) were carried out using the ADE4 package in R (R Development Core Team 2009) to test for association between untransformed F_{ST} and stream distance (10,000 permutations).

Life-history ecology—Data for ecological attributes for *P. caprodes* and *P. pantherina* were compiled from previously published literature (Page 1983, James et al. 1991, Turner et al. 1996). Characteristics included maximum body size, maximum number of ova, mean ova diameter, life-span, and age at maturity (Table 1).

Results

The mtDNA sequences obtained from 70 *P. pantherina* and 110 *P. caprodes* included 9 and 22 haplotypes, respectively (Tables 2; 3). The haplotypes of *P. pantherina* included 10 substitutions (9 synonymous; 1 nonsynonymous); those for *P. caprodes* included 32 substitutions (27 synonymous; 5 nonsynonymous). Patterns of polymorphism did not differ significantly from neutrality ($P > 0.100$ for Tajima's D , Fu and Li's F , Fu's D).

The four primary haplotypes (I, O, Q, R) detected in *P. caprodes* differ by 4 to 10 mutational steps and occurred in all four populations at relatively uniform frequencies

(Fig. 2). The haplotypes central to the network were rare or absent. In contrast, the network for *P. pantherina* had a relatively common central haplotype (F) detected in three of the populations (LR, BC, CR). Haplotypes clustered by geographic proximity, with LR and GR haplotypes at one extreme, BC intermediate, and CR at the other extreme.

The two species had similar levels of haplotype diversity (Table 4) because the relatively low number of haplotypes in *P. pantherina* was balanced by greater evenness of abundance among haplotypes (Fig. 2). Otherwise, the within-population metrics of diversity were much larger in *P. caprodes* than in *P. pantherina* (Table 4). At each of the four localities, the value was larger in *P. caprodes* than in *P. pantherina*; hence, Mann-Whitney U-tests showed, that across all populations, H_R , k and θ_S were significantly higher for *P. caprodes* than for *P. pantherina* ($P < 0.05$). The mutation-scaled estimate of population sizes at each locality were four to 16 times greater in *P. caprodes*.

The AMOVAs demonstrated marked differences in geographic structure between the two species, with 36.1% and <0.01% of total diversity attributable to differences among populations in *P. pantherina* and *P. caprodes*, respectively. All pairwise F_{ST} values for *P. pantherina* (0.27-0.80) were highly significant ($P < 0.001$) and all were negative (= zero divergence) for *P. caprodes* (Table 5). The sample from the Cossatot River was the most divergent population of *P. pantherina* with a mean F_{ST} of 0.71 in comparisons with the other three populations.

The pairwise estimates of number of migrants ranged from 0.1 to 1.3, with only one pair, Little River and Glover River, showing more than one migrant per generation. Consistent with the global lack of divergence among populations for *P. caprodes*,

pairwise estimates of F_{ST} were slightly negative for every population pair and indicative of true values close to zero (panmixia). Consequently, there was no evidence of isolation-by-distance in *P. caprodes*. For *P. pantherina*, F_{ST} increased linearly with geographic distance (Fig. 3), but the relationship was not statistically significant ($r = 0.55$, $P = 0.08$).

Discussion

Syntopic populations of *Percina pantherina* and *P. caprodes* from four sites in the Little River basin show patterns of genetic structure consistent with predictions based on differences in life history traits. In previous analyses, *P. caprodes* showed higher rates of gene flow than 14 other species of darters (Turner et al. 1996; Turner and Trexler 1998), and this was also seen in the comparison with *P. pantherina*. The earlier studies showed positive relationships between gene flow and female body size and other traits associated with higher fecundity. Of the species examined in those studies, *P. caprodes* had the largest body size and clutch size and the smallest eggs; this pattern holds with the addition of *P. pantherina*. Given the results of past research, it is no surprise that *P. caprodes* shows greater evidence of gene flow and less geographically structured genetic variation than *P. pantherina*. A unique aspect of this study, however, is that, in contrast to previous studies of darters, I compared *P. caprodes* with a species taken from the same localities, reducing the possibility that differences in genetic structure might represent some unknown extrinsic factor. The results highlight the considerable influence of life history on patterns of patterns of genetic variation.

Besides its effect on fecundity, larger body size likely affects other features of life history that contribute to greater gene flow in *P. caprodes*. One such feature is heightened

individual dispersal ability (Turner and Trexler 1998). For North American fishes in general, McAlister et al. (1986) suggested that the effect on dispersal ability explains why larger fishes have wider geographic distributions. Correspondingly, *P. caprodes* has the one of the largest body sizes and the widest geographic range of any darter (Page 1983; Page and Burr 2011).

Another life-history factor potentially related to body size is degree of habitat specialization. *Percina pantherina* is an obligate stream-dweller that occupies upland situations with clear water and gravel or rubble substrata (James and Maughan 1989). On the other hand, *P. caprodes* arguably has broader habitat requirements than any other darter. Page and Burr (2011: 528) commented that *P. caprodes* is “Usually found over gravel and sand in medium-sized rivers but can be found almost anywhere from small, fast-flowing rock bottomed streams to vegetated lakes.” In Oklahoma, the species is “most common in lakes or in clear streams” (Miller and Robison 2004:381). Larger body size (within darter limits) might confer survival advantages in lowland, open-water communities, while at the same time not compromising ability to function in smaller upland habitats.

The differences between *P. caprodes* and *P. pantherina* in the distribution of genetic diversity likely were established well before construction of dams on the Little River system, which occurred about 40 years ago (Zale et al. 1994), preventing upstream movement into the streams we sampled. A general principal is that population changes induced by fragmentation are slow, creating time-lags between fragmentation and the manifestation of effects (Ewers and Didham 2005). Two relics of genetic structure prior to damming of Little River tributaries are (1) the lack of statistically significant

divergence among populations of *P. caprodes* and (2) the marginally significant ($P = 0.08$) indication of isolation-by-distance in *P. pantherina*. The latter relationship was significant in an analysis with additional populations ($P = 0.01$; Chapter III).

The molecular data indicate that prior to damming *P. caprodes* in the Little River system was effectively panmictic. For example, the mutation-scaled estimates of historical population size ($\theta_S = 2N_e\mu$) for individual populations (0.0043-0.0059) were equivalent to the “global” estimate (0.0058) across the four populations. In contrast, the historical estimates for individual populations (0.0003-0.0011) of *P. pantherina* were two to seven times smaller than the global estimate (0.0026). The molecular signal of isolation-by-distance in *P. pantherina* suggests that, prior to damming, the populations were near or at migration-drift equilibrium (Hutchison and Templeton 1999), a condition that disappeared with damming. The tributary populations of *P. caprodes* and *P. pantherina* are moving toward new equilibria established by the imbalance created by nearly complete barriers to upstream gene flow.

Implications for conservation—The post-damming changes in the genetic structure of *P. pantherina* should be much more dramatic than those for *P. caprodes*. The estimates of present effective population sizes for *P. pantherina* populations in different tributaries of the Little River are extremely small (5-69; Chapter III). Hence, genetic drift is severe, and the threat of extinction via genetic and demographic factors is relatively high. On the other hand, the threat of extirpation of *P. caprodes* from the Little River system is much lower. The relatively broad habitat requirements of the species allows it to use reservoirs as winter and summer thermal refuges, whereas *P. pantherina* depends on deep pools

within stream habitats, a potential limiting factor for the abundance of the species (Schaefer et al. 2003). The reservoirs also serve as refuges during severe drought, the primary threat for catastrophic losses of *P. pantherina* (Williams et al. 1999). Occurrence in the reservoirs, together with higher dispersal abilities mean that locally extirpated populations of *P. caprodes* in upstream areas are likely to be replaced by re-colonization.

Another factor affecting susceptibility to catastrophic losses of the two species include differences in life-history schedules. The larger *Percina caprodes* has a maximum life span of 3.5 yrs (Page 1983), while *P. pantherina* survives less than 1.5 yrs (James et al. 1991). *Percina caprodes* does not mature until age-class 2, but has two spawning age classes (2 and 3), whereas the breeding population of *P. pantherina* consists only of age-1 individuals (Page 1983; James et al. 1991). The iteroparous strategy of *P. caprodes* increases the opportunities for dispersal and buffers the effect of annual fluctuations in genetic drift (Allendorf 2007) and increases the likelihood of persisting through a catastrophic year for reproduction and recruitment. On the other hand, a single catastrophic year could drastically reduce the viability of *P. pantherina*. These two species likely represent the extremes for the fishes of the Little River system in terms of threats posed by artificial damming.

References

- Allendorf FW, Luikart G (2007) Conservation and the genetics of populations. Blackwell Pub., Malden, Oxford
- Avise JC, Arnold J, Ball RM, Bermingham E, Lamb T, Neigel JE, Reeb CA, Saunders NC (1987) Intraspecific phylogeography: the mitochondrial DNA bridge between

- population genetics and systematics. Annual review of ecology and systematics 18, 489-522
- Avise JC (1992) Molecular population structure and the biogeographic history of a regional fauna: a case history with lessons for conservation biology. *Oikos* 63, 62-76
- Avise JC (2009) Phylogeography: retrospect and prospect. *Journal of Biogeography* 36, 3-15
- Bandelt H-J, Forster P, Röhl A (1999) Median-joining networks for inferring intraspecific phylogenies. *Molecular biology and evolution* 16, 37-48
- Blanchet S, Rey O, Etienne R, Lek S, Loot G (2010) Species-specific responses to landscape fragmentation: implications for management strategies. *Evolutionary Applications* 3, 291-304
- Ehrich D, Krebs CJ, Kenney AJ, Stenseth NC (2001) Comparing the genetic population structure of two species of arctic lemmings: more local differentiation in *Lemmus trimucronatus* than in *Dicrostonyx groenlandicus*. *Oikos* 94, 143-150
- Eliades N, Eliades D (2009) Haplotype Analysis: software for analysis of haplotype data. Forest Goettingen (Germany): Genetics and Forest Tree Breeding, Georg-August University Goettingen
- Ewers RM, Didham RK (2006) Confounding factors in the detection of species responses to habitat fragmentation. *Biological Reviews* 81, 117-142
- Excoffier L, Lischer HE (2010) Arlequin suite ver 3.5: a new series of programs to perform population genetics analyses under Linux and Windows. *Molecular ecology resources* 10, 564-567

- Frankham R (1996) Relationship of genetic variation to population size in wildlife.
Conservation Biology 10, 1500-1508
- Fu YX (1996) New statistical tests of neutrality for DNA samples from a population.
Genetics 143, 557-570
- Fu YX, Li WH (1993) Statistical tests of neutrality of mutations. Genetics 133, 693-709
- Harris L, Taylor E, Tallman R, Reist J (2012) Gene flow and effective population size in two life-history types of broad whitefish *Coregonus nasus* from the Canadian Arctic. Journal of Fish Biology 81, 288-307
- Hubbs, C, and Pigg, J (1976) The effects of impoundments on threatened fishes of Oklahoma. Ann. Okla. Acad. Sci. 5, 113-117
- Hutchison DW, Templeton AR (1999) Correlation of pairwise genetic and geographic distance measures: inferring the relative influences of gene flow and drift on the distribution of genetic variability. Evolution 1898-1914
- James PW, Maughan OE, Zale AV (1991) Life-history of the leopard darter *Percina pantherina* in Glover River, Oklahoma. American Midland Naturalist 125, 173-179
- Kimura M (1984) The neutral theory of molecular evolution. Cambridge University Press
- Librado P, Rozas J (2009) DnaSP v.5: A software for comprehensive analysis of DNA polymorphism data. Bioinformatics 25, 1451-1452
- Lynch DT (2010) Phylogeography of the Ozark logperch, *Percina caprodes fulvitaenia*, in the Red and Arkansas river basins. MS thesis, Oklahoma State University, Stillwater

- Mantel N (1967) The detection of disease clustering and a generalized regression approach. *Cancer research* 27, 209-220
- Mayden RL (1988) Vicariance biogeography, parsimony, and evolution in North-American fresh-water fishes. *Systematic Zoology* 37, 329-355
- McAllister DE, Platania SP, Shueler FW, Baldwin ME, Lee DS (1986) Ichthyofaunal patterns on a geographical grid. In: Hocutt CH, Wiley EO (eds) *Zoogeography of freshwater fishes of North America*. Wiley, New York, pp17-51
- McDonald DB, Potts WK, Fitzpatrick JW, Woolfenden GE (1999) Contrasting genetic structures in sister species of North American scrub-jays. *Proceedings of the Royal Society of London Series B: Biological Sciences* 266, 1117-1125
- Nei M (1987) *Molecular evolutionary genetics*. Columbia University Press.
- Östergren J, Nilsson J (2012) Importance of life-history and landscape characteristics for genetic structure and genetic diversity of brown trout (*Salmo trutta L.*). *Ecology of Freshwater Fish* 21, 119-133
- Page LM (1983) *Handbook of darters*. TFH Publications Neptune City, New Jersey
- Page L, Burr B (2011) *Peterson field guide to freshwater fishes of North America north of Mexico*. Houghton Mifflin Harcourt, New York
- Portnoy DS, McDowell JR, Heist EJ, Musick JA, Graves JE (2010) World phylogeography and male-mediated gene flow in the sandbar shark, *Carcharhinus plumbeus*. *Molecular Ecology* 19, 1994-2010
- Schaefer JF, Marsh-Matthews E, Spooner DE, Gido KB, Matthews WJ (2003) Effects of barriers and thermal refugia on local movements of the threatened leopard darter, *Percina pantherina*. *Environmental Biology of Fishes* 66, 391-400

- Slatkin M (1993) Isolation by distance in equilibrium and non-equilibrium populations. *Evolution* 264-279
- Tajima F (1989) Statistical method for testing the neutral mutation hypothesis by DNA polymorphism. *Genetics* 123, 585-595
- Tamura K, Peterson D, Peterson N, Stecher G, Nei M, Kumar S (2011) MEGA5: molecular evolutionary genetics analysis using maximum likelihood, evolutionary distance, and maximum parsimony methods. *Molecular biology and evolution* 28, 2731-2739
- Tibbets CA, Dowling TE (1996) Effects of intrinsic and extrinsic factors on population fragmentation in three species of North American minnows (Teleostei: Cyprinidae). *Evolution* 1280-1292
- Turner TF, Trexler JC (1998) Ecological and historical associations of gene flow in darters (Teleostei : Percidae). *Evolution* 52, 1781-1801
- Turner TF, Trexler JC, Kuhn DN, Robison HW (1996) Life-history variation and comparative phylogeography of darters (Pisces: Percidae) from the North American central highlands. *Evolution* 50, 2023-2036
- United States Fish and Wildlife Service (1978) Final threatened status and critical habitat for the leopard darter. *U. S. Federal Register* 43:3711-3716
- Waples RS (1987) A multispecies approach to the analysis of gene flow in marine shore fishes. *Evolution* 385-400
- Watterson G (1975) On the number of segregating sites in genetical models without recombination. *Theoretical population biology* 7, 256-276

Williams LR, Echelle AA, Toepfer CS, Williams MG, Fisher WL (1999) Simulation modeling of population viability for the leopard darter (Percidae: *Percina pantherina*). *The Southwestern Naturalist* 44, 470-477.

Wright S (1951) Fisher and Ford on "the Sewall Wright effect". *American Scientist* 39, 452-479

Zale AV, Leon SC, Lechner M, Maughn OE, Ferguson MT, O'Donnell S, James B, and James PW (1994) Distribution of the threatened leopard darter, *Percina pantherina* (Osteichthyes: Percidae). *The Southwestern Naturalist* 3, 11–20

Table 1 Life history characteristics of *Percina caprodes* and *Percina pantherina*. Data compiled from Page (1983), James (1991) and Turner and Trexler (1996).

Species	Maximum SL (mm)	Number of ova	Ovum diameter (mm)	Maximum age (yr)	Age at first spawning
<i>P. caprodes</i>	180	397	1.2	3.5	2
<i>P. pantherina</i>	92	146	1.4	1.5	1

Table 2 MtDNA (ND2) haplotypes of *Percina caprodes* sampled from four collection sites of the Little River system (populations: LR, GR, BC and CR).

Haplotype	Populations				total
	LR	GR	BC	CR	
A		2	1		3
B	1	1	1		3
C	3				3
D	1				1
E		1			1
F				1	1
G				1	1
H				1	1
I	12	5	6	11	34
J	1				1
K	2				2
L	1				1
M				1	1
N			1	1	2
O	8	4	2	5	19
P				1	1
Q	5	2	3	4	14
R	3	3	4	3	13
S				1	1
T		1			1
U	4		1		5
V				1	1
Total	41	19	19	31	110

Table 3 MtDNA (*cyt b*) haplotypes of *Percina pantherina* sampled from four collection sites of the Little River system (populations: LR, GR, BC and CR).

Haplotype	Populations				Total
	LR	GR	BC	CR	
A				14	14
B			7		7
C			6		6
D			1		1
E	1				1
F	5		3	3	11
G		5			5
H	2				2
I	9	14			23
Total	17	19	17	17	70

Table 4 Summary statistics for populations for *P. caprodes* and *P. pantherina*. Column headings: F_{ST} (Weir and Cockerman 1984), gene flow (Nm ; Slatkin 1993), haplotypes by count (H) and rarefaction (H_R), haplotype diversity (h), mean pairwise differences per site (k) and population diversity index $\theta_S = 2N_e\mu$ per site (Watterson, 1975).

Species/site (N)	F_{ST}	Nm	H	H_R	h	k	θ_S
<i>P. caprodes</i>							
Little River (41)			11	6.8	0.857	0.00569	0.00434
Glover River (19)			8	6.7	0.877	0.00636	0.00559
Buffalo Creek (19)			8	6.6	0.854	0.00651	0.00587
Cossatot River (31)			12	7.3	0.841	0.00633	0.00587
overall (110)	-0.010	-51.32	22	6.8	0.846	0.00586	0.00575
<i>P. pantherina</i>							
Little River (17)			4	3.0	0.654	0.00098	0.00109
Glover River (19)			2	1.0	0.409	0.00049	0.00035
Buffalo Creek (17)			4	3.0	0.713	0.00133	0.00109
Cossatot River (17)			2	1.0	0.654	0.00098	0.00109
overall (70)	0.361	0.44	9	2.0	0.815	0.00244	0.00256

Table 5 Pairwise genetic structure of *Percina pantherina* and *P. caprodes* between four tributaries of the Little River System. Estimates of pairwise F_{ST} (Weir and Cockerman 1984) values above diagonal; Pairwise \hat{M} estimates below diagonal. Significance level calculated by 10,000 permutations. Negative F_{ST} values are artifacts of calculation when the true value approaches zero.

Species	Population			
	LR	GR	BC	CR
<i>P. pantherina</i>				
LR	-	0.271*	0.349*	0.694*
GR	1.3	-	0.553*	0.799*
BC	0.9	0.4	-	0.638*
CR	0.2	0.1	0.3	-
<i>P. caprodes</i>				
LR	-	-0.016	-0.011	-0.015
GR	∞	-	-0.045	-0.032
BC	∞	∞	-	-0.030
CR	∞	∞	∞	-

* Significant F_{ST} values ($P < 0.05$)

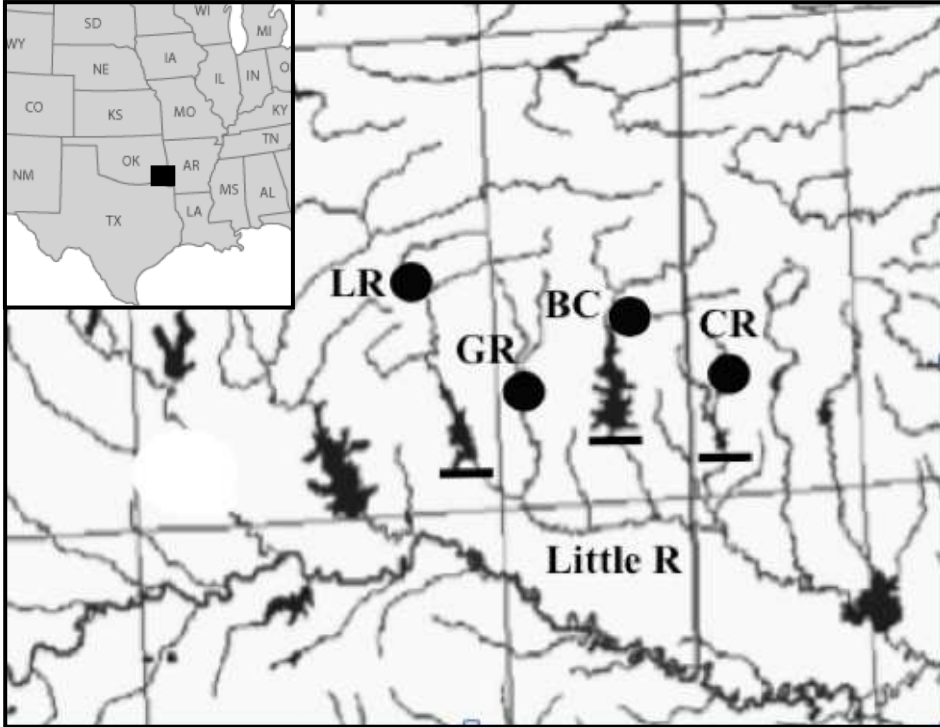

Figure 1 Collection localities (circles) of the Little River basin for *Percina caprodes* and *P. pantherina*. Horizontal bars indicate reservoir dams. [Little River (LR): 34°31'48.00"N, 95° 0'55.00"W, Glover River (GR): 34° 5'50.93"N, 94°54'10.49"W, Buffalo Creek (BC): 34°22'9.10"N, 94°37'22.76"W, Cossatot River (CR): 34°17'42.69"N, 94°10'22.41"W). Inset shows the study region of central North America.

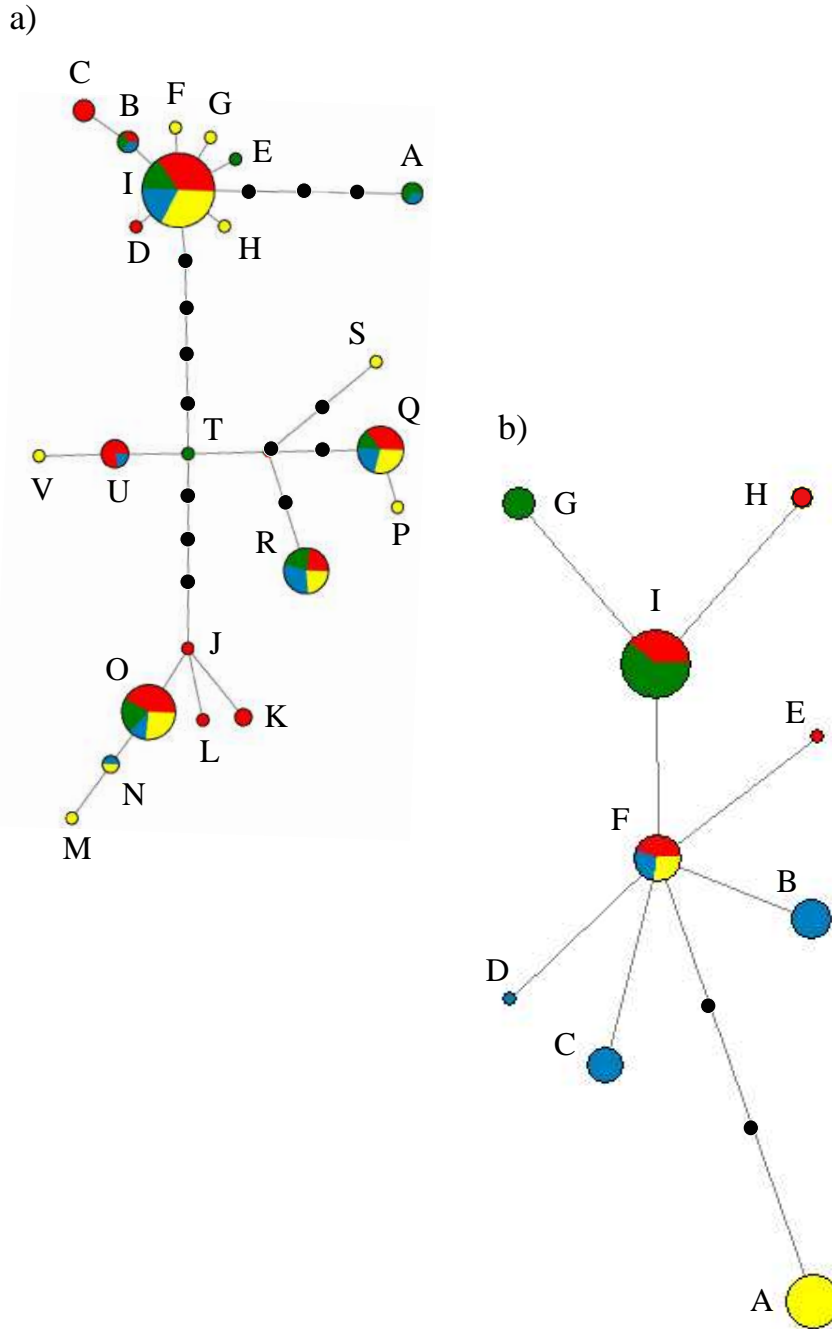

Figure 2 Haplotype networks of mtDNA sequences from four tributaries of a) *Percina caprodes* and b) *Percina pantherina*. Haplotype designations correspond to Table 1 and Table 2. Colors represent tributaries (red = LR, green = GR, blue = BC, yellow = CR, black = unsampled haplotype) and size is proportional to frequency within and between species. Each haplotype is one mutational step (=1 bp) from adjacent haplotypes.

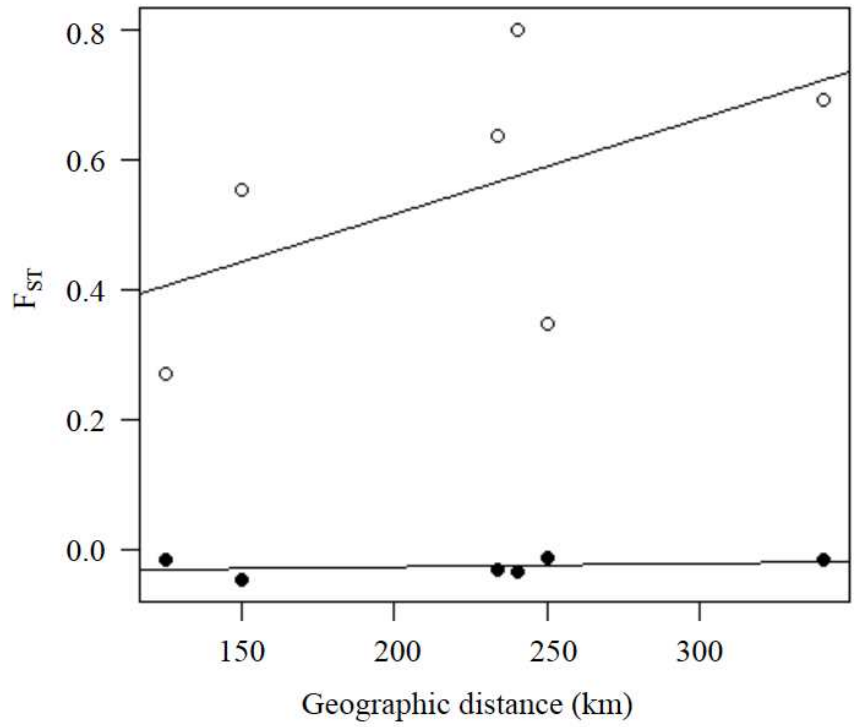

Figure 3 Isolation by distance analysis of *Percina caprodes* (solid circles) and *Percina pantherina* (open circles). Regression lines are based on untransformed F_{ST} and linear stream distance.

Appendix 1 Primers and thermocycler parameters used in PCR amplifications and sequencing reactions for ND2 and cytochrome *b* genes.

<i>gene</i>	<i>primer</i>	<i>sequence (5' – 3')</i>	<i>temp. profile</i>			<i>references</i>
ND2	562L	TAAGCTATCGGGCCCATAACC	94°	48°	72°	George et al. 2006
	449H	TGCTTAGGGCTTTGAAGGCTC	, 1 m	1 m	2 m	
Cyt <i>b</i>	HA	CAACGATCTCCGGTTTACAAG	94°	48°	72°	Schimdt et al. 1998, 1999
	LA	GTGACTTGAAAAACCACCGTT	1 m	1 m	2 m	

CHAPTER V

ISOLATION AND CHARACTERIZATION OF 10 POLYMORPHIC MICROSATELLITE MARKERS FOR THE OUACHITA HIGHLANDS ENDEMIC *NOTROPIS SUTTKUSI* (TELEOSTEI: CYPRINIDAE)

Human pressures primarily associated with urbanization, forestry practices, over-mining of groundwater, and reservoir construction threaten the exceptional aquatic endemism of the Ouachita Highlands of southeastern Oklahoma and southwestern Arkansas, USA. At present, there is a need for hypervariable markers useful for understanding population structure and historical demography, thereby helping to provide a framework for conservation efforts. In this paper we describe 10 microsatellite markers for *Notropis suttkusi* (rocky shiner), a species endemic to the Ouachita Highlands. We characterize these markers on 40 individuals from Blue River in Oklahoma. The loci yielded 3-23 alleles per locus, with mean observed and expected heterozygosities of 0.679 and 0.729, respectively. The availability of these markers will facilitate studies of the conservation genetics of *N. suttkusi* and should be useful for other members of the *Notropis rubellus* complex.

A high degree of endemism characterizes the aquatic Ouachita Highlands fauna of North America (Mayden 1985; Miller and Robison 2004). This offers an exceptional opportunity to investigate evolutionary consequences of historical and contemporary drainage structure on biodiversity and provides a basis for multispecies, regional conservation efforts. Hypervariable markers suitable to provide a population-genetic perspective on conservation management generally are not available for the Ouachita Highlands endemics or their close relatives. One such species, *Notropis suttkusi* (rocky shiner), is a small cyprinid of the *N. rubellus* complex, a group of seven allopatric species, three of which are undescribed (Berendzen et al. 2008). *Notropis suttkusi* is restricted to Ouachita Highland tributaries of the Red River from the Little River system of southeastern Oklahoma and southwestern Arkansas to Blue River in southcentral Oklahoma (Miller and Robison 2004). The species is morphologically (Humphries and Cashner 1994) and genetically (Berendzen et al. 2008) distinct from other members of the widespread *Notropis rubellus* complex. In this paper we characterize 10 polymorphic microsatellite DNA loci developed for *N. suttkusi* and provide summary statistics of variability for each locus.

Microsatellite libraries were generated by Genetic Identification Services (GIS; www.genetic-id-services.com) from an individual *N. suttkusi* collected from an upland reach of the Blue River, a Red River tributary in southcentral Oklahoma, USA (34° 27' 16.07" N, 96° 38' 6.46" W). Primer pairs were designed to amplify microsatellite-containing clones from libraries enriched for four tetra-nucleotide repeats (AAAC, CATC, TACA and TAGA). We tested 15 primer pairs of candidate loci using 40 individuals collected from the same locality. Of these loci, 10 amplified reliably, showed

polymorphism and are characterized herein. We used the following amplification parameters for all loci: 95°C for 12 min, 35 cycles of 94°C for 40 s, 57°C for 40 s, 72°C for 30 s, and 72°C for 4 min. The reaction mix (15 µL total volume) contained 1-3 ng of template DNA in 1 µL ddH₂O, 0.5 µL of each primer (10 µM), 4 µL ddH₂O and 9 µL True Allele PCR mix (Applied Biosystems, Inc.). Each primer pair was fluorescently labeled with blue (6FAM), green (HEX) or yellow (NED) dye. Capillary electrophoresis using an ABI 3130 Genetic Analyzer was performed on solutions containing the combined post-amplification products from 2-3 loci (0.5 µL each locus), 0.5 µL 400HD ROX size standard (Applied Biosystems, Inc.), and 9 µL formamide. Length variants were visualized and genotyped using GeneMarker 2.4.0 (SoftGenetics LLC, State College, Pennsylvania, USA).

We used GenAIEx v. 6.5 (<http://biology.anu.edu.au/GenAIEx/Welcome.html>) to compute numbers of alleles per locus and observed and expected heterozygosity, and GENEPOP v. 4.2 (<http://genepop.curtain.edu.au>) for tests of Hardy-Weinberg equilibrium (HWE) and gametic disequilibrium. Significance levels were adjusted for multiple tests using the sequential Bonferroni correction for $\alpha = 0.05$. Additionally, we used Micro-checker 2.2.3 (<http://www.microchecker.hull.ac.uk>) to test for null alleles and heterozygote deficiencies.

Primer sequences and summary statistics for 10 polymorphic loci are provided in Electronic Supplementary Material (Table 1). Numbers of alleles per locus ranged from 3 to 23, and observed and expected heterozygosity ranged from 0.13 to 0.97 and 0.13 to 0.94, respectively. There was no evidence of significant deviation from HWE or gametic disequilibrium after Bonferroni correction. However, results from Micro-checker indicate

low-frequency null alleles at three loci (estimated frequency): D102 (0.04), D108 (0.06) and D3 (0.08). The 10 microsatellite loci developed here should be particularly useful in studies of the historical demography and population structure of *N. suttkusi* and related members of the *N. rubellus* complex. In turn, the knowledge from such studies of *N. suttkusi* will inform the development of regional conservation management plans for the Ouachita Highlands aquatic fauna.

References

- Berendzen PB, Simons AM, Wood RM, Dowling TE, Secor CL (2008) Recovering cryptic diversity and ancient drainage patterns in eastern North America: Historical biogeography of the *Notropis rubellus* species group (Teleostei: Cypriniformes). *Mol Phyl Evol* 46:721-737
- Humphries JM, Cashner RC (1994) *Notropis suttkusi*, A new cyprinid from the Ouachita Uplands of Oklahoma and Arkansas, with comments on the status of Ozarkian Populations of *N. rubellus*. *Copeia* 1994:82-90
- Mayden RL (1985) Biogeography of Ouachita Highland fishes. *Southwest Nat* 30:195-211
- Miller RJ, Robison HW (2004) *Fishes of Oklahoma*. University of Oklahoma Press, Norman

Table 1 Microsatellite markers characterized for *Notropis suttkusi* from Blue River. Number of repeats are indicated from the individual used to generate the library; N = number of individuals, N_A = number of alleles, Size = allele size in number of base pairs, H_O = observed heterozygosity, H_E = expected heterozygosity, and P_{HW} = probability of Hardy-Weinberg equilibrium.

Locus	Primer sequence (5'–3')	Repeat	N	N_A	Size (bp)	H_O	H_E	P_{HW}
Ns_A1	F: GCTGCGTGTCTTGTAAGC R: CCTGCTCATAATCCAGAGG	(GTTT) ₅	35	5	108 - 124	0.657	0.707	0.501
Ns_A4	F: AACAGGCAAGAGGTCTTAAAC R: ACCAGAGTTTCACATCACAAC	(AAAC) ₆	38	4	220 - 276	0.474	0.491	0.801
Ns_A103	F: TCTTGATGGTTGCACTGAGTT R: CTTTGGCATTGGGTAGTAGG	(ATT) ₃ ...(GTTT) ₅	38	3	203 - 219	0.132	0.125	0.979
Ns_B9	F: GGCTTCCTTGGCTTTTAC R: TTTGTCTGTCTAACCATCTGTG	(GTAG) ₂₅ ...(AGAC) ₅	31	16	156 - 288	0.871	0.884	0.215
Ns_B106	F: TTCTGAGTCTGAGGATGTGAC R: TGGCTATCAACATAGACAAAGA	(GATG) ₉	37	6	267 - 339	0.622	0.731	0.570
Ns_C109	F: TGCTGGAAACACACTCACATC R: TCCCTAACCATAGTTGGCTTGT	(TACA) ₂₀	38	12	216 - 348	0.605	0.628	0.817
Ns_D3	F: AGCCAATATCTCAGTAACATGC R: CGTGCATTTTCAGACTGTTTAC	(TAGA) ₂₂	38	20	230 - 362	0.789	0.930	0.381
Ns_D102	F: CGTTGTTACACACTTGTTGC R: TACCCCTTCAGCCTCATC	(TAGA) ₃₀	35	26	142 - 282	0.857	0.938	0.110
Ns_D108	F: AGAGCCTTGAGGACAGAAGA	(TAGA) ₃₀	37	18	179 - 303	0.811	0.915	0.502

	R: CATCCGACTAACGGTTCG							
Ns_D111	F: ACATTGATTTTCTCAGGTGTTC	(TAGA) ₂₁	38	23	200 - 328	0.974	0.939	0.424
	R: TCAGCCTGTGAAAGAGAGG							
<hr/>								
Mean			36.5	13.3		0.679	0.729	

CHAPTER VI

DEVELOPMENT AND CHARACTERIZATION OF EIGHT POLYMORPHIC TETRA- NUCLEOTIDE MICROSATELLITE MARKERS FOR THE THREATENED LEOPARD DARTER (*PERCINA PANTHERINA*)

We describe eight tetra-nucleotide microsatellite markers for the leopard darter (*Percina pantherina*), a federally threatened percid fish endemic to Oklahoma and Arkansas. We tested these markers on 42 individuals from two localities and provide summary statistics on population variability. Eight loci yielded two to 12 alleles per locus. These markers contribute to the availability of markers for programs aimed at monitoring and managing the genetic resources of *P. pantherina* and related taxa.

In this paper we describe primers for eight microsatellite DNA loci and provide summary statistics of variability for each locus in two populations of a federally threatened percid fish, the leopard darter, *Percina pantherina*. The species is endemic to southeastern Oklahoma and southwestern Arkansas where it is restricted to five tributaries of the Little River system (Jones et al. 1984; James and Maughan 1989; Zale et al. 1994). Its restricted geographic range, together with habitat modification by reservoir impoundment and population loss below reservoirs, led to federal listing as threatened in 1978 (USFWS 43 FR 3715, 1978). Subsequent monitoring by the United States Fish and Wildlife Service demonstrates the need for continued conservation concern.

A previous description of genetic diversity based on allozymes indicated low levels of genetic diversity within and among tributary populations of *P. pantherina* (Echelle et al. 1999). The loci reported here, together with advances in analytical approaches (Beaumont 1999, 2003; Waples 2008, 2010), should allow improved insight into population structure and demographic history of *P. pantherina*, including estimates of the timing of population bottlenecks and the potential effect of reservoir construction on effective population size.

An initial screening indicated polymorphism at eight of 10 loci from libraries generated by Genetic Identification Services (GIS; www.genetic-id-services.com). We assayed the polymorphic loci for two populations of *P. pantherina* in isolated tributaries of the Little River, one from the geographic center (site 1: Mountain Fork River, $N=24$) and one from the eastern limit of the range (site 2: Cossatot River, $N=18$). The following PCR amplification parameters were used for all loci: 95°C for 12 min, 35 cycles of 94°C for 40 s, 57°C for 40 s, 72°C for 30 s, and 72°C for 4 min. The reaction mix (15 μ L total volume) contained 1-3 ng of template DNA in 1 μ L ddH₂O, 0.5 μ L of each primer (10 μ M), 4 μ L ddH₂O and 9 μ L True Allele PCR mix

(Applied Biosystems, Inc.). Each primer pair was fluorescent-labeled with blue (6FAM), green (HEX) or yellow (NED) dye. Capillary electrophoresis using an ABI 3130 Genetic Analyzer was performed on solutions containing the combined post-amplification reaction mixes from 2-3 loci (0.5 μ L each locus), 0.5 μ L 400HD ROX size standard (Applied Biosystems, Inc.), and 9 μ L formamide (Applied Biosystems, Inc.). Capillary electrophoresis was performed on an ABI 3130 Genetic Analyzer. Length variants were visualized and genotyped using GeneMarker 1.91 (SoftGenetics LLC, State College, Pennsylvania, USA).

We used Microchecker (Van Oosterhout 2004) to test for null alleles and heterozygote deficiencies, GenAlEx v. 6 (Peakall and Smouse 2006) to compute numbers of alleles per locus, and GENEPOP v. 4.0 (<http://genepop.curtain.edu.au/>; Raymond and Rousset 1995; Rousset 2008) for tests of Hardy-Weinberg equilibrium (HWE), linkage disequilibrium, and exact tests of genic differentiation between the two populations. Significance levels were adjusted for multiple tests using the sequential Bonferroni correction (Rice 1989). The eight loci assayed showed no evidence of null alleles or heterozygote deficiencies (Table 1). Additionally, after Bonferroni correction, no loci showed deviations from HWE or and there was no evidence of linkage disequilibrium. Prior to adjustment, only one HWE test showed evidence of potentially significant deviation (B4 at site 1; $P = 0.013$). Exact tests revealed that the two populations examined were significantly divergent ($P < 0.05$) at six of the eight loci.

The development of successful programs of monitoring and management of the genetic resources of imperiled species require the availability of markers with sufficient variability to allow detailed knowledge of genetic structure. The microsatellite markers reported here for *P. pantherina*, together with the 16 loci reported for *P. rex* (Dutton et al. 2008) should contribute significantly toward this need for the genus *Percina*, which comprises about 50 species (Page

and Burr 2010), 23 of which are listed as vulnerable, threatened, or endangered by the American Fisheries Society (Jelks et al. 2008).

References

- Beaumont MA (1999) Detecting population expansion and decline using microsatellites. *Genetics* 153, 2013-2029
- Beaumont MA (2003) Estimation of population growth or decline in genetically monitored populations. *Genetics* 164:1139-1160
- Dutton DJ, Roberts JH, Angermeier PL, Hallerman EM. 2008. Microsatellite markers for the endangered Roanoke logperch, *Percina rex* (Percidae) and their potential utility for other darter species. *Mol Ecol Res* 8:831-4
- Echelle AF, Echelle AA, Williams LR, Toepfer CS, Fisher WL (1999) Allozyme perspective on genetic variation in a threatened percid fish, the leopard darter (*Percina pantherina*). *Amer MidlNat* 142:393-400
- Helfman G (2007) Fish conservation: a guide to understanding and restoring global aquatic biodiversity and fishery resources. Island Press, Washington
- James PW, Maughan OE (1989) Spawning behavior and habitat of the threatened leopard darter, *Percina pantherina*. *Southwest Nat* 34:298-301
- Jelks HL., Walsh SJ, Burkhead NM, Contreras-Balderas S, Diaz-Pardo E, Hendrickson DA, Lyons J, Mandrak NE, McCormick F, Nelson JS, Platania SP, Porter BA, Renaud CB, Schmitter-Soto JJ, Taylor EB, and Warren ML Jr. (2008) Conservation status of imperiled North American freshwater and diadromous fishes. *Fisheries* 33:372-407

- Jones RN, Orth DJ, Maughn OE (1984) Abundance and preferred habitat of the leopard darter, *Percina pantherina*, in Glover Creek, Oklahoma. *Copeia* 1984:378-384
- Page LM, Burr, BM (2011) Peterson field guide to freshwater fishes of North America north of Mexico. Houghton Mifflin Harcourt, New York
- Peakall R, Smouse PE (2006) GenEIAx 6: genetic analysis in Excel. Population genetic software for teaching and research. *Mol Ecol Notes* 6:288–295
- Raymond M, Rousset F (1995) GENEPOP (version 3.2): population genetics software for exact tests and ecumenicism. *J Hered* 86:248–249
- Rice WR (1989) Analyzing tables of statistical tests. *Evolution* 43:223–225
- Rousset F (2008) Genepop'007: a complete reimplementaion of the GENEPOP software for Windows and Linux. *Mol Ecol Res* 8, 103–106
- United States Fish and Wildlife Service (1978) Final threatened status and critical habitat for the leopard darter. *Federal Register* 43:3711-3716
- Van Oosterhout C, Hutchinson WF, Willis DPM, Shipley P (2004) MICRO-CHECKER: software for identifying and correcting genotyping errors in microsatellite data. *Mol Ecol Notes* 4:535–538
- Waples RS (2008) LDNE: a program for estimating effective population size from data on linkage disequilibrium. *Mol Ecol Res* 8:753-756
- Waples RS, and Do C (2010) Linkage disequilibrium estimates of contemporary N_e using highly variable genetic markers: a largely untapped resource for applied conservation and evolution. *Evol App* 3:244-262

Zale AV, Leon SC, Lechner M, Maughn OE, Ferguson MT, O'Donnell S, James B, and James
PW (1994) Distribution of the threatened leopard darter, *Percina pantherina*
(Osteichthyes: Percidae). Southwest Nat 3:11–20

Table 1 Microsatellite markers characterized in two populations of *Percina pantherina* (1 and 2). Number of repeats and allele size range are from the individual used to generate the library; N = number of individuals, N_A = number of alleles, P_{Diff} = probability from tests of genic differentiation, H_O = observed heterozygosity, H_E = expected heterozygosity, and P_{HW} = probability of Hardy-Weinberg equilibrium.

Locus	Primer sequence (5'–3')	Repeat	Range (bp)	Site	N	N_A	P_{Diff}	H_O	H_E	P_{HW}
A5	F: TGCAACATTATCAGAGGAAAAG	(AAAC) ₇	194-234	1	24	2	0.317	0.083	0.080	1.000
	R: ACCACTTACACCATTGTCATTC			2	17	2		0.059	0.057	0.901
A103	F: AACTCCTCCTGCATCATCTAC	(TTGT) ₁₂	168 - 196	1	24	7	0.085	0.375	0.332	1.000
	R: GAAATGGGACAAATTATGTGAC			2	18	2		0.222	0.198	1.000
C105	F: GCCATAACCGATCAGTAAGTG	(TAGT) ₁₉	239 - 287	1	23	11	0.00 ^s	0.826	0.855	0.464
	R: GATGCAGTGTATTTGGGACAT			2	18	5		0.722	0.637	0.964
B4	F: GACCCGATACCGGATAAG	(GATG) ₁₃	120 - 168	1	24	7	0.00 ^s	0.917	0.803	0.295
	R: AAGGCAGATAGTTGAAGAACC			2	18	5		0.667	0.642	1.000
B6	F: GGACAACCAGAGGACAACAG	(TCCA) ₁₀	130 - 186	1	23	6	0.00 ^s	0.696	0.796	0.288
	R: AGACCCAATACCGGATAAGC			2	17	5		0.529	0.471	0.619
B102	F: ATAATGGTGCAATAGCAGTCTG	(TCCA) ₁₃	200 - 260	1	23	12	0.00 ^s	0.913	0.873	0.588
	R: TCAGGGGTACACAAATAAACTG			2	17	5		0.647	0.680	0.675
B103	F: TTCTGTATGTGTGCTGTGTGA	(ATCC) ₇	214 - 246	1	22	1	0.033 ^s			
	R: AGCCTGATTGTTTCTCTATGC			2	17	2		0.235	0.208	1.000

B105	F: GGAATCGTACAAACAATGTTCT	(CCAT) ₁₁	296 - 348	1	23	10	0.00 ^s	0.696	0.852	0.291
	R: TCCACACAATATGAAGACAATG			2	18	4		0.667	0.690	0.026 ⁿ
Mean					20.4	5.4		0.550	0.545	

^s Significant between-site differences in allelic frequencies ($P < 0.05$)

ⁿ Nonsignificant after Bonferroni correction

VITA

Michael R. Schwemm

Candidate for the Degree of

Doctor of Philosophy

Thesis: The Zoogeography of the Ouachita Highland Fishes

Major Field: Zoology

Biographical:

Education:

Completed the requirements for the Doctor of Philosophy in Zoology at Oklahoma State University, Stillwater, Oklahoma in December 2013.

Completed the requirements for the Master of Science in Biology at Arizona State University, Tempe, Arizona in December 2006.

Completed the requirements for the Master of Science in Zoology at Arizona State University, Tempe, Arizona in December 1998.

Research Interests: Population Genetics and Conservation of Fishes

Professional Memberships: American Society of Ichthyologists and Herpetologists, Southwestern Association of Naturalists, Desert Fishes Council, Southeastern Fishes Council, American Fisheries Society