

UNIVERSITY OF OKLAHOMA  
GRADUATE COLLEGE

MODERN INNOVATIONS IN AMERICAN TRUMPET MOUTHPIECE DESIGN

A DOCUMENT  
SUBMITTED TO THE GRADUATE FACULTY  
in partial fulfillment of the requirements for the  
Degree of  
DOCTOR OF MUSICAL ARTS

By  
KATHERINE L. KLINEFELTER  
Norman, Oklahoma  
2014

MODERN INNOVATIONS IN AMERICAN TRUMPET MOUTHPIECE DESIGN

A DOCUMENT APPROVED FOR THE  
SCHOOL OF MUSIC

BY

---

Dr. Karl Sievers, Chair

---

Dr. Eldon Matlick

---

Dr. Marvin Lamb

---

Dr. Matthew Stock

---

Dr. Kurt Gramoll

© Copyright by KATHERINE L. KLINEFELTER 2014  
All Rights Reserved.

## Table of Contents

List of Figures.....	viii
Abstract.....	ix
Chapter 1: Introduction.....	1
Purpose of Study.....	1
Methodology.....	1
Definition of Terms .....	2
Rim.....	3
Cup.....	3
Alpha Angle.....	4
Throat... ..	5
Backbore.....	5
Outer Shank .....	6
Gap.....	6
Overall Length.....	6
Material.....	7
Plating .....	7
Related Literature .....	7
Scientific Studies Related to Trumpet Mouthpieces .....	13
The Modern Trumpet Player .....	17
Chapter 2: Overview of American Trumpet Mouthpieces .....	19
A Brief History of the Trumpet in America .....	19
Vincent Bach Mouthpieces.....	21

Biography .....	21
Mouthpiece Design.....	27
Renold Schilke.....	29
Biography .....	29
Mouthpiece Design.....	34
Robert Giardinelli .....	36
Biography .....	36
Mouthpiece Design.....	38
John Parduba .....	39
Biography .....	39
Mouthpiece Design.....	40
Bob Reeves .....	41
Biography .....	41
Mouthpiece Design.....	42
Gary Radtke.....	43
Biography .....	43
Mouthpiece Design.....	44
David Monette .....	44
Biography .....	44
Mouthpiece Design.....	46
Chapter 3: Interviews with Modern Makers.....	49
Asymmetric Mouthpieces.....	49
Overview of Company .....	49

Interview.....	50
Curry Mouthpieces .....	57
Overview of Company .....	57
Interview.....	59
Pickett Mouthpieces .....	70
Overview of Company .....	70
Interview.....	70
Warburton Mouthpieces .....	79
Overview of Company .....	79
Interview.....	80
Wedge Mouthpieces .....	87
Overview of Company .....	87
Interview.....	87
Chapter 4: Conclusions.....	101
Summary.....	101
Conclusions .....	109
Further Research.....	111
Final Thoughts.....	112
Bibliography.....	113
Books.....	113
Articles .....	113
Dissertations and Theses .....	117
Interviews .....	118

Websites .....	119
Appendix A: Interview Questionnaire.....	120
Appendix B: Glossary of Terms.....	121
Appendix C: IRB Approval.....	123
Appendix D: List of Contact Information for Mouthpiece Manufacturers Interviewed in this Study .....	124
Appendix E: Octave Designation Terminology .....	125
Appendix F: Mouthpiece Throat Sizes.....	126

## List of Figures

Figure 1 - Trumpet Mouthpiece .....	2
Figure 2 - High Alpha Angle (red) .....	4
Figure 3 - Low Alpha Angle (red).....	4
Figure 4 - Cross-section of Standard Bach Mouthpiece from the Bach Mouthpiece Manual .....	28
Figure 5 – Schilke Mouthpiece.....	35
Figure 6. Giardinelli Screw Rim Mouthpiece from 1975 Mouthpiece Catalogue .....	39
Figure 7 - Parbuda Double-Cup Mouthpiece .....	40
Figure 8 - Reeves Sleeves.....	42
Figure 9 - Monette RAJA with Integrated Mouthpiece.....	46
Figure 10 - Asymmetric Mouthpiece .....	51
Figure 11 - Curry L-Style Cup (3C).....	61
Figure 12 - Curry True Radius Cup (1.25C) .....	61
Figure 13 - Curry Zoomed Comparison True Radius vs L-Style.....	61
Figure 14 - Curry 1.5 C and 1.5 C-S Overlay .....	67
Figure 15 - Curry 1.5 C and 1.5 C-S Overlay Zoomed .....	68
Figure 16 - Wedge Mouthpiece .....	89
Figure 17 - Wedge Two-Part Backbore.....	93
Figure 18 - Octave Designation: All Octaves.....	125
Figure 19 - Octave Designation: C4-C5 .....	125
Figure 20 - Throat Sizes (wire gauge).....	126



## **Abstract**

In the early part of the 20<sup>th</sup> century, technological advancements in machinery allowed the production of trumpet mouthpieces to become more consistent than ever before. Vincent Bach and his contemporaries improved upon the previous standards set by European mouthpiece designers such as Leopold August Schmitt. This document explores the ways in which current North American manufacturers Peter Pickett, Terry Warburton, Dave Harrison, John Lynch, and Mark Curry are improving upon designs of Bach and his contemporaries in accordance with innovations in current trumpet designs, such as modifications in bell weight, valve blocks, tuning slides, and longer leadpipes, and the needs of the modern trumpet player.

# **Chapter 1: Introduction**

## **Purpose of Study**

This study explores how trumpet mouthpieces have evolved from the standard set by Vincent Bach, Renold Schilke, and others in the early 20<sup>th</sup> century through the lens of five prominent North American mouthpiece manufacturers. It seeks to answer questions about each constituent part of the mouthpiece, as well as considerations for orchestral, commercial, and modern cross-over players that were not factors at the time that Bach designed his mouthpieces. In addition, this study will address how changes in modern trumpet design affect mouthpiece design; a completely unexplored area. Previous studies have used scientific methods to describe some aspects of trumpet mouthpieces, as well as choices players make when searching for mouthpieces for commercial and for jazz music, but none explores what drives changes in mouthpiece design from the manufacturer's perspective, or how specific manufacturers improve upon traditional design.

## **Methodology**

Interviews were the primary method used to gather information in this study. A questionnaire (Appendix A) was given to each of the five subjects at least a week before their interview to give each sufficient time to consider his or her answer. After this, interviews based on the questionnaire were given over the phone and recorded. Results were analyzed and summarized in each subject's section of the third chapter. Before publishing, each subject was given the opportunity to read his section to ensure accuracy, and add information about or clarify any issue he deemed significant. The

data gathered by all of the interviews was analyzed for similarities and differences in the concluding chapter.

### **Definition of Terms**

The trumpet mouthpiece consists of several components. Altering any of these elements will affect how the mouthpiece sounds, feels while playing, or both. Some of these effects are agreed upon by most experts while others are subject to some degree of debate. In preparation for the interviews, each part of the trumpet mouthpiece will be described in detail. Figure 1 shows where each of these parts is located on the mouthpiece itself.

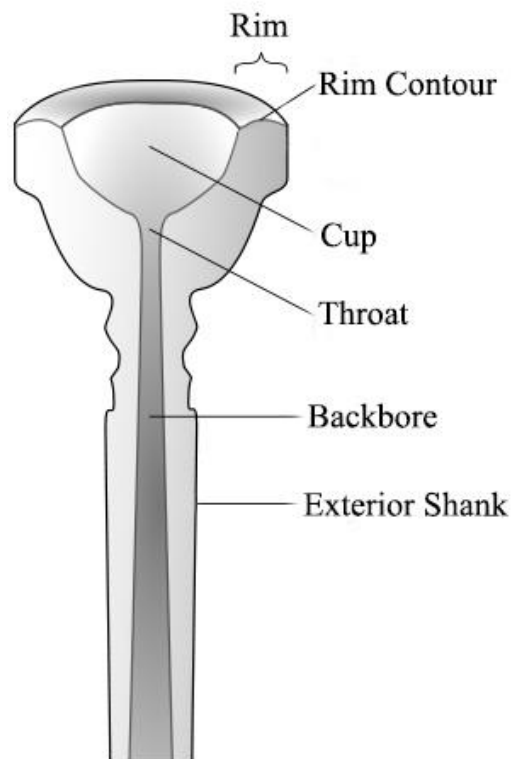

**Figure 1 - Trumpet Mouthpiece**

### *Rim*

The rim of the mouthpiece affects many aspects of trumpet performance including endurance, attack, flexibility, and sound quality, as well as the feel and comfort of the mouthpiece. In addition, different aspects of the rim affect different aspects of playing. A wide rim is thought to be more comfortable and beneficial to endurance, but can reduce flexibility and deaden the sound.<sup>1</sup> The articulation also becomes less crisp as the rim becomes wider.

The contour of the rim also affects the way the rim works, however there is debate over what effect this has. The shoulder of the rim is the outside edge and this is thought to only affect the way the lips grip the mouthpiece. The bite is the inside edge of the rim. It is generally accepted that a sharper bite allows for quicker response and more precise articulation.<sup>2</sup> If the bite is too sharp, it can become difficult to play smooth legato lines. A bite that is too sharp can cut the lips or reduce endurance. A soft bite is generally comfortable, but may produce poor attacks.

### *Cup*

Much research has been done in regard to the cup of the mouthpiece. It is generally agreed that a deeper cup produces a broader, warmer sound while a shallow cup gives the trumpet a brighter sound well suited to the upper register. Deeper cups are usually used in orchestral settings whereas shallow cups are commonly found in commercial settings.

The contour and shape of the cup is also important. Modern trumpet mouthpieces usually use a cup which blends the conical (V-shape) used by modern

---

<sup>1</sup> Hickman 2006, 261

<sup>2</sup> Ibid., 263.

French horns (as well as historical instruments) and a purely bowl-shaped cup, which was used by trumpets and trombones before the twentieth century.<sup>3</sup> A bowl-shaped mouthpiece produces a very brilliant tone whereas a conical (V-shaped) mouthpiece produces a warmer tone. Combining the two cup types for use on the trumpet was first done by Renold Schilke for Harry James.<sup>4</sup>

### *Alpha Angle*

The alpha angle is a term coined by Gary Radtke of GR Technologies to describe the relationship of the rim to the radius of the cup.<sup>5</sup> It is the angle which occurs where the wall of the cup begins to slope inward from the rim. This angle is thought to either impede or help lip vibrations. A low alpha angle drops more steeply than a high alpha angle.

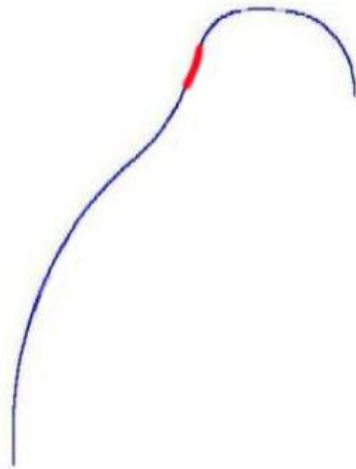

**Figure 2 - High Alpha Angle (red)<sup>6</sup>**

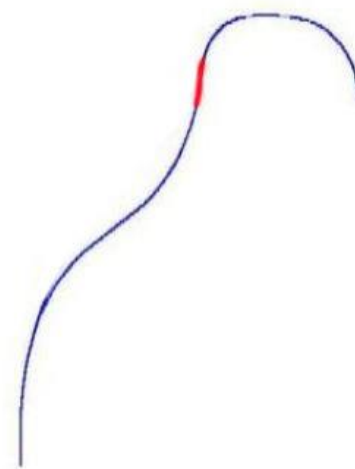

**Figure 3 - Low Alpha Angle (red)<sup>7</sup>**

---

<sup>3</sup> Hickman 2006, 260

<sup>4</sup> Ibid., 260

<sup>5</sup> Ibid., 263

<sup>6</sup> GR Technologies

### *Throat*

The throat is the smallest opening in the mouthpiece through which air passes.<sup>8</sup>

The throat shoulder is located at the entrance to the throat and is usually smooth and rounded, though this shape varies widely by brand and model. The smooth and rounded throat shoulder is generally preferred because it provides the player with greater flexibility and a warmer sound. Slotting is more secure with a sharp shoulder, but can limit flexibility.<sup>9</sup>

The throat's diameter is measured in machinists' wire gauge sizes. Though the shape and overall length of the throat do contribute to the sound and feel, the diameter is thought to be most important. In general, a larger throat has less resistance to blowing, produces a warmer sound, allows for better control in the upper register, but takes more control and embouchure strength to play.<sup>10</sup> Smaller throats can aid the production of notes in the upper register, but can restrict volume and cause a sense of greater resistance.<sup>11</sup> When the throat is too large, endurance suffers and an airy tone may be present. Either of these issues can cause the harmonics to become uncharacteristic of the modern trumpet tone.<sup>12</sup>

### *Backbore*

The backbore is the tapered section of the mouthpiece that directly follows the throat. A backbore is considered "tight" if the taper is fairly gradual. An "open" backbore tapers outward faster, and then evens out toward the end of the shank. A tight

---

<sup>7</sup> Ibid.

<sup>8</sup> Blackburn. 1978, 11

<sup>9</sup> Hickman 2006, 263

<sup>10</sup> Blackburn. 1978, 11

<sup>11</sup> Hickman 2006, 263

<sup>12</sup> Blackburn. 1978, 11

backbore causes a mouthpiece to have greater resistance and an edgier sound, while an open backbore produce mellower sounds and has less resistance.<sup>13</sup> The backbore, in interaction with the leadpipe, also affects the intonation of the instrument. If the backbore is too tight, the high register becomes flat and the low register becomes sharp. If it is too open, the opposite occurs.<sup>14</sup>

### *Outer Shank*

The shank is the part of the mouthpiece which fits into the mouthpiece receiver. It is tapered in such a way to provide a specific amount of gap between the start of the leadpipe and the end of the mouthpiece.<sup>15</sup> Morse #1 is the standard rate of taper.

### *Gap*

The “gap” is the space between where the mouthpiece ends and the leadpipe begins. The function and effect of the gap is a matter that is up for debate among many mouthpiece and trumpet manufacturers. Some, such as Renold Schilke, believed that it was best to have no gap at all. Others, such as Bob Reeves, believe that a gap is necessary and must be adjusted to fit the individual player and his or her equipment. Some other manufacturers believe that the effect of the gap is negligible. Factors that the gap has been suggested to influence include response, core, slotting, centering, flexibility, tone color, and intonation, among others. Each manufacturer will address this issue in detail in his individual chapter.

### *Overall Length*

The length of a mouthpiece can vary from manufacturer to manufacturer. The length itself is calculated by taking the length of the backbore, the length of the throat,

---

<sup>13</sup> Hickman 2006, 266

<sup>14</sup> Ibid.

<sup>15</sup> Ibid., 267.

and the depth of the cup into account.<sup>16</sup> The effects of the length were not explored in any of the background material consulted while conducting this study, but will be addressed in the interviews.

### *Material*

The majority of conventional mouthpieces are made of brass. The exact formula of brass varies from manufacturer to manufacturer. Some manufacturers also experiment with other metals, plastic, and other non-metal materials. A scientific study on the effects of material in trumpet mouthpieces was done by Francis F. Wilcox. In this study, it was found that metal was preferable to plastic in most cases. The differences between the types of metal were marginal.<sup>17</sup> Further study in this area is required before a definitive statement can be made about what causes a material to work better than another material.

### *Plating*

Because most conventional mouthpieces are made of brass, these mouthpieces must be plated to prevent skin irritations. The most common materials used to plate mouthpieces are silver and gold, though platinum, nickel, and nickel-silver are also used. Gold is described to give the mouthpiece a warmer feel than silver and tends to feel more slippery on the lips as well. The sound is not affected by the choice of plating.

## **Related Literature**

Several other researchers have examined various aspects of trumpet mouthpieces and their effect on the sound, player preferences, and audience perception.

---

<sup>16</sup> Hickman 2006, 268

<sup>17</sup> Wilcox 1957, 116



The following dissertations provide insight into what has already been researched and provide a good foundation for the research detailed in this document.

Conte Jay Bennett's dissertation, "Selection of Trumpets and Mouthpieces by Classically-Trained Players for Commercial Music Performance," sought to discover what types of mouthpieces and B-flat trumpets classically-trained trumpet players typically use for commercial music and if they differ from what is used for classical music. He also looked into whether the type of mouthpiece and trumpet changed depending on whether the trumpet player's role was as lead or a section player in commercial music, or principal or a section player in classical music. Finally, he explored what influences a classically trained player in his or her choice of trumpet and mouthpiece for commercial playing.

The author of this study conducted interviews with four cross-platform trumpet players in order to address these issues. The results were varied. In regard to the mouthpiece questions, two out of the four players postulated that a narrow rim diameter is important for commercial work. There were also mixed opinions on the backbore and on whether or not to use a different mouthpiece when switching between commercial and classical music. Two changed to different mouthpieces when playing jazz solos as opposed to lead but all played the same mouthpiece when playing principal in an orchestra as they do when performing in an orchestral section. The only matter that was completely agreed upon was the importance of a shallow cup to produce the correct sound and to aid endurance when playing commercial music. This dissertation did not address how these varied preferences affect mouthpiece design from a manufacturer's perspective.

Ian Darrington's dissertation, "Trumpet Mouthpieces: An In-Depth Study," explored why a bright, edgy trumpet tone has emerged, primarily in the context of jazz and commercial music, and when exactly this happened. Darrington then drew parallels between this change in tone and changes in mouthpiece design.

The author conducted a survey of lead trumpet parts from 1930 to 2000 in order to determine when the expansion of range happened. The 1970s were determined to be the decade with the most demanding range written for lead trumpet.<sup>18</sup>

A listening test was conducted with regulars at a jazz club, students in a jazz orchestra, and a class of twelve-year-olds without musical experience. This was done to determine if the differences in tone color were discernable by the audience. A metal attachment which fits to the bottom of the cup called a "booster" was used to add weight to a mouthpiece. An average of 35% found the tone to be identical in the jazz club and in the youth jazz orchestra audiences.<sup>19</sup> The audience of untrained children had a higher percentage of people who found the tones to be identical. For those who could tell the difference, about half preferred the tone with the booster and the other half preferred it without.

A comparison of tone using a shallow versus a deep mouthpiece was also done. In this test, about 32% of the first two audiences could not tell a difference and, again, a greater number of the third group could not tell. Of those who could tell a difference, about 58% preferred the deeper mouthpiece and 32% had no preference.<sup>20</sup>

The focus of this dissertation was the exploration of the effects of the change of trumpet tone which correlated to an equipment change to aid the increased range

---

<sup>18</sup> Darrington 2004, 155

<sup>19</sup> Ibid., 229

<sup>20</sup> Ibid., 230

demands in the 1970s. This effect was tested on both trained and untrained audiences. The assumption is that the equipment changed as a result of the increased range demands, but once again, this is not directly addressed to the manufacturers and technical specifications about the equipment change are not addressed.

In his dissertation, “A Comparative Study of the Effect of Various Mouthpieces on the Harmonic Content of Trumpet Tones,” Robert Eugene Hallquist investigated the effect of changing mouthpiece size on the tone of the trumpet and whether this affects all players in the same way.

Hallquist did tests using three subjects, a college freshman, a college senior, and a professional trumpet player, all of which were described to have a good tone quality. Each performed four notes at three different dynamic levels on three different mouthpieces. Bach 1.5C, 7C, and 10.5C mouthpieces were used. Each had cups described as medium-shallow, but the volume of the cup varied because of the diameter of the cup.<sup>21</sup> The author did not mention any other differences among these mouthpieces.

Four different forms of analysis were used in this study: resonance curve analysis, spectrum analysis, one-third-octave band analysis, and statistical analysis. The results showed that as dynamics increased, the difference between the mouthpieces decreased. Also, the smaller mouthpiece did not always produce a greater quantity of higher harmonics according to these analyses. The difference among the mouthpieces was most clearly illustrated on the lower notes than the higher notes. The author did not use any tests with human subjects listening for the differences observed in these analyses. Hallquist was unable to make definitive conclusions based on the small

---

<sup>21</sup> Hallquist 1979, 28

number of subjects but did create a method which could be used by future investigators to analyze trumpet tones.

“The Effect of Mouthpiece Cup Depth and Backbore Shape on Listeners’ Categorizations of Tone Quality in Recorded Trumpet Excerpts,” a dissertation by John Stanley Kusinski, used a group of 73 subjects to test if listeners can categorize trumpet tone qualities in excerpts played with mouthpieces with varying cup depths and backbore shapes. These were tested separately: there were no tests combining the two. The author also postulated that there would be a difference between the categorizations given by brass players, non-brass playing musicians, and non-musicians.

The study yielded no significant correlation to the listeners’ categorizations in any of these groups.<sup>22</sup> This could be due in part to the wording of the questionnaire which the listeners filled out because many of the value judgments listed (warm, dark, etc) are abstract in their meaning. Because of this, the author was also unable to prove or disprove a difference among the categorization given by the three different groups.

Francis F. Wilcox’s dissertation, “An Investigation of Certain Properties of Selected Materials for Trumpet Mouthpieces,” explores the effects of different materials on the playing quality of a mouthpieces, reactions to the different feel of different materials, whether physical factors such as hardness and tensile strength have an effect on either the feel or playing qualities of the mouthpiece, and finally, whether there is a non-corroding inexpensive alternative to brass with properties that are at least as good, if not better than, traditional brass.<sup>23</sup>

---

<sup>22</sup> Kusinski 1984, 71

<sup>23</sup> Wilcox 1957, 1

The mouthpieces used in this study were made to be exactly the same shape with the only variable being the material. The materials tested were an aluminum alloy, leaded phosphor bronze, tellurium copper, heat-treatable steel 1141, Teflon, nylon, Rexolite, and Lucilite.<sup>24</sup> All of these were tested both in the standard weight and skeletonized (see glossary). A plated brass mouthpiece was used as a control.

Each mouthpiece was tested using a mechanical embouchure to create the sound and analyzed with electrical equipment. This test showed that the material of the mouthpiece did not cause changes in pitch and that the difference in tone quality was very small. The response range of skeletonized aluminum alloy and Teflon were largest and nylon had the smallest. Most required the same amount of air pressure with the exception of skeletonized steel alloy which needed more, and skeletonized aluminum alloy, Teflon, nylon, Rexlite, and Lucite which required less.<sup>25</sup>

Player testing was done with a group of ten beginners (college music majors who were studying trumpet in a methods class), ten trumpet majors, and ten professionals. These tests resulted in a wide variety of opinions. Most professionals and trumpet majors did not like the feel of plastic, or were indifferent to it, while four beginners did prefer it.<sup>26</sup> There were no strong preferences among the different types of metal, though the only votes for plastic mouthpieces being the best came from beginners.

The author concluded that plastic has weaker upper partials. This was confirmed both by the tone analysis and the player testing. There were also slight differences in the amount of air pressure required to produce a sound. The plastic

---

<sup>24</sup> Wilcox 1957, 17-20

<sup>25</sup> Ibid., 70

<sup>26</sup> Ibid., 95-104

mouthpieces were described as feeling warmer and softer though there was disagreement as to whether they were rough or smooth and whether this was good or bad. The only verified differences in tone were found in the plastic mouthpieces. The author believes that the aluminum alloy used in this study is a promising alternative to brass. It could easily be machined and costs less than brass. The response is easier, though modification would have to be done in order to improve corrosion resistance. All testing was done using mouthpieces created by the author. Commercially available mouthpieces by manufacturers were not analyzed and manufactures were not questioned about their material preferences.

### **Scientific Studies Related to Trumpet Mouthpieces**

Dr. Arthur Benade's book, *Horns, Strings, and Harmony*, explains sound production in musical instruments using examples from everyday life and proposes experiments the reader can replicate to further illustrate these concepts. For the purpose of this document, I will focus on sound production in brass instruments specifically relating to the mouthpiece and embouchure.

Benade discusses the fact that the lips should oscillate in accordance with pressure variations produced by blowing air through them into the instrument.<sup>27</sup> In reality, there are other factors that can alter the pitch and sound production. This can be proven by having a brass player bend a note flat. Lips are heavy, which means that the air in the horn does not allow as easy of a vibration as with reed instruments. Brass players can use the lips to alter pitches, but the instrument itself does guide the player to correct pitches, which Benade calls "privileged frequencies."<sup>28</sup>

---

<sup>27</sup> Benade1992, 165

<sup>28</sup> Ibid., 166

He calculated the best frequencies of vibration of a cylindrical pipe to be 100, 300, 500, and 700 cycles per second, but when he tested this, he found that his lips vibrated at approximately 100, 125, 150, 165, 175, 225, 233, 250, and 303Hz.<sup>29</sup> What his experience proved was that the lip reed has too much mass to be controlled completely by the pipe's vibrational mode frequencies.<sup>30</sup> The lips have "privileged frequencies" at which they also vibrate at sub-multiples of the vibrational modes (300/2, 300/3, 300/4, etc). The "privileged modes" are close to what is commonly known as the partial series by brass players.

Benade suggests that the depth of the cup of the mouthpiece affects the tone color of the instrument as well as a player's ability to slot desired pitches. If the bottom of the cup has a sharp edge, as is found in most C-cup mouthpieces, the tone can be described as hard and incisive. A rounded off edge produces a softer, smoother tone.<sup>31</sup> These descriptions are metaphorical. Physics has not yet given a technical description for this effect, but it is certain to be a very subtle change.<sup>32</sup>

*Trumpet Science: Understanding Performance Through Physics, Physiology, and Psychology* by Ben Peterson discusses the science of trumpet performance in relation to physics, physiology, and psychology. For the purpose of this study, I will focus on the physics section, specifically that which relates to the trumpet mouthpiece.

Peterson considers the trumpet mouthpiece to be the most important component of the instrument in terms of overall function. He also asserts that performers have widely varied preferences in regard to the design of the mouthpiece. He goes on to

---

<sup>29</sup> Benade1992, 167

<sup>30</sup> Ibid., 168

<sup>31</sup> Ibid., 189

<sup>32</sup> Ibid., 190

explain the function of each part of the mouthpiece, which has been summarized earlier in this chapter.

The author describes the mouthpiece as a section of a coupled resonator (the other section being the trumpet itself).<sup>33</sup> A coupled resonator can be defined as two resonators working in conjunction with one another in a system. The mouthpiece functions as a Helmholtz resonator, similar to an empty bottle with air blown across the top. The changes in air pressure cause the air within the bottle to resonate at a specific frequency, which produces a pitch.<sup>34</sup> The throat of the mouthpiece acts in the same way as the opening of the bottle. The vibrations produced pass into the trumpet.

Peterson explains other characteristics of the mouthpiece that classify it as a resonator. Each mouthpiece has a unique resonant frequency (popping frequency).<sup>35</sup> This resonant frequency reinforces the harmonics close to its own frequency when coupled with the trumpet and makes these pitches more secure. Most mouthpieces have a resonant frequency between A $\flat$ 5 and B $\flat$ 5.

The author has also found that the mouthpiece interacts differently with certain sections of the trumpet at different ranges. In the low range, the mouthpiece couples with the trumpet to form a tube with a volume equal to that of the mouthpiece. When the pitch rises, the resonating tube increases in length past the actual length of the mouthpiece.<sup>36</sup> This lowers the pitch of the harmonics within the partial series, bringing them closer to being in tune.

---

<sup>33</sup> Peterson 2012, 58

<sup>34</sup> Ibid., 58

<sup>35</sup> Ibid., 58

<sup>36</sup> Ibid., 58



An article titled “Trumpet Mouthpiece Manufacturing and Tone Quality” by Massimo Zicari, Jennifer MacRitchie, Lorenzo Ghirlanda, Alberto Vanchieri, Davide Montorfano, Maurizio C. Barbato, and Emiliano Soldini was published in *The Journal of the Acoustical Society of America*. The authors of this study state that extensive acoustical and technical measurements do not help musicians perform and that there are many contradictory opinions among performers in regards to embouchure function.<sup>37</sup> The authors do agree that the tone quality is dependent upon the size and shape of the mouthpiece and that the sound can be understood by studying the input impedance profile.<sup>38</sup> Acoustical impedance refers to the sound pressure that is produced when an acoustic medium is vibrated at a specific frequency. When combined with the trumpet, the mouthpiece acts as an “impedance multiplier” producing a system of oscillation.<sup>39</sup>

The authors state that the volume of the mouthpiece helps determine the sound quality and that it relates inversely to the resonant frequency.<sup>40</sup> Other elements not related to the physical mouthpiece or instrument that affect the timbre are attack, release, pitch, and loudness.

A study was done using mouthpieces with different internal cup contours, both with rounded and sharp throats. The results of the study were analyzed using a simulation of air flow, an analysis of the sound spectra, subjective responses from the players, and an analysis of the perception of the relevance of the timbral difference

---

<sup>37</sup> Zicari et al 2013, 3872

<sup>38</sup> Ibid., 3873

<sup>39</sup> Ibid., 3873

<sup>40</sup> Ibid., 3873

among these mouthpieces.<sup>41</sup> The mouthpieces were tested alone and with an experimental trumpet recorded by three professional trumpet players.

The study proved that the geometric properties of the mouthpiece do affect the observable properties of the sound using the sound spectrum analysis and simulation of air flow.<sup>42</sup> The spectral components above 8000Hz were more pronounced in the C-shaped cup than the V-shaped cup which implies a brighter sound with a greater quantity of high overtones.<sup>43</sup> The sharp bite had more high overtones than the rounded bite. The C-shaped cup had greater air recirculation inside the cup which means that it requires more air pressure to play as shown in the air flow simulation.<sup>44</sup>

Interviews with the players addressed the areas of intonation, attack, timbre, flexibility, and responsiveness. The C-shaped cup scored the lowest overall. The C-shaped cup with a sharp bite was the worst mouthpiece overall and was recognized 100% of the time by the players, a sharp contrast to the other mouthpieces in the test.<sup>45</sup> The listening test yielded similar results with the C-shaped mouthpiece being the least desirable.

### **The Modern Trumpet Player**

The mouthpieces of Bach, Schilke, Giardinelli, and the others were designed primarily for either orchestral trumpet players or for jazz or big band trumpet players. Presently, many trumpet players have to be able to play in all genres. The modern trumpet player generally has to be a crossover artist, performing in both orchestral and commercial styles.

---

<sup>41</sup> Ibid., 3874

<sup>42</sup> Zicari et al 2013, 3879

<sup>43</sup> Ibid., 3879

<sup>44</sup> Ibid., 3877

<sup>45</sup> Ibid., 3880

Also, the design of trumpets themselves has changed. C trumpets tend to have longer leadpipes now than they did in the early part of this century. Other subtle changes have been made in order to improve their intonation. Trumpet manufacturers are experimenting with different brass alloys in order to enhance playing characteristics of the instrument. New tuning slide radii are being used with the intention of altering the resistance of the instrument. Heavyweight trumpets have also entered the market fairly recently. Today's trumpet players need mouthpieces that can be used with their modern trumpets in order to perform music in multiple genres.

## **Chapter 2: Overview of American Trumpet Mouthpieces**

Prior to the First World War, brass mouthpieces were cut by machinists, and varied in design.<sup>46</sup> After the war, the beginnings of contemporary brass mouthpieces emerged and were different than those that came before because of technology, as well as changing musical tastes. Mouthpieces were now made on a lathe which enabled them to be accurately. These more advanced mouthpieces, created by Vincent Bach, Renold Schilke, and others, became the standard for American professional trumpet players after the First World War.<sup>47</sup> Jack White conducted a survey of high school band directors, college teachers, and professional trumpet players and determined that the most commonly used mouthpieces at the time his document was written in 1980 were Bach, Schilke, and Giardinelli.<sup>48</sup> This chapter explores the standard trumpet mouthpieces established in early 20<sup>th</sup> century America in order to provide a context for the newer mouthpieces described in succeeding chapters.

### **A Brief History of the Trumpet in America**

In American orchestras, the cornet was frequently used instead of the trumpet during the early part of the 20<sup>th</sup> century. Cornets were used almost exclusively in American orchestras before the First World War and continued to be preferred over trumpets in various orchestras until the 1930s.<sup>49</sup>

The Chicago Symphony, which was established in 1891, listed a pair of cornet players and a pair of trumpet players with the cornet listed as principal until 1898 when

---

<sup>46</sup> Smith 1996, 22

<sup>47</sup> Ibid.

<sup>48</sup> White 1980, 35

<sup>49</sup> Smith 1995, 5

all four were listed as trumpets.<sup>50</sup> The principal trumpet, Christian Rodenkirchen, was a cornet soloist from Cologne.

The Cincinnati Symphony's first principal trumpet from 1895-1898 was Herman Bellstedt who was a celebrated cornet soloist, performing as a soloist with the Gilmore Band after leaving the orchestra and the Sousa Band after that, where he alternated as soloist with Herbert L. Clarke and Walter Rogers.<sup>51</sup> It is unknown when his successors switched to using primarily trumpet.

The Metropolitan Opera orchestra hired Edwin Franko Goldman as cornet soloist from 1899 to 1909.<sup>52</sup> The Boston Symphony played cornets starting in 1881 and continued into the early 20<sup>th</sup> century. Vincent Bach was a member of the Boston Symphony Orchestra during its transition to the use of trumpet.

Part of the reason for the preference of cornet over trumpet in the orchestra was that trumpets were associated with jazz music which was seen as undignified at this time in American history. As jazz became a reputable genre, the trumpet became an acceptable instrument in the orchestra and the disreputable stigma eventually dissolved.

The cornet mouthpiece at this time had a v-shaped design similar to that of a modern French horn mouthpiece or flugelhorn mouthpiece. Orchestral trumpet players who were used to this had to make adjustments when orchestras began to prefer having the parts played on trumpets instead of cornets. Vincent Bach's mouthpieces are a result of his experimentation in effort to figure out the American trumpet sound and

---

<sup>50</sup> Crown 2010, 21

<sup>51</sup> Camus

<sup>52</sup> Gelles and Meckna

style because he had grown up a cornet player, like many trumpet players in American orchestras at this time.<sup>53</sup>

Before Bach's mouthpieces, most quality trumpet mouthpieces were imported from Europe. Schmitt mouthpieces were found most commonly in orchestras before Bach, and Besson before Schmitt. The work of Bach, Schilke, and Giardinelli laid a foundation on which the American mouthpieces of today are based.

### **Vincent Bach Mouthpieces**

#### *Biography*

Vincent Bach was born Vincenz Schrottenbach in Austria in 1890.<sup>54</sup> He started playing the violin when he was six years old and added piano soon after, but had a stronger desire to play the trumpet. In Gymnasium, his interest in violin had declined, though he was still interested in music, and he became more interested in scientific fields including physics and electricity.<sup>55</sup> His stepfather believed that he wouldn't amount to anything due to his interest in music, so when he was given the choice of whether to enroll in Maschinenbauschule (an engineering school) or the Vienna Conservatory, he chose engineering school.

The summer before he entered engineering school, Bach often attended concerts and particularly enjoyed trumpet solo passages by John Hartl, the first trumpet in the Vienna Tonkünstler Orchestra at the time. These experiences further strengthened his desire to become a trumpet player. In 1905, at the age of fifteen, he purchased his first trumpet, a rotary valve trumpet.<sup>56</sup> He studied with the principal trumpet of the Kurpark

---

<sup>53</sup> Smith 1994, 5

<sup>54</sup> Ibid.

<sup>55</sup> Fladmoe 1975, 26

<sup>56</sup> Ibid., 28

orchestra who agreed to give him free lessons due to the fact that his step-father disapproved of his musical aspirations.<sup>57</sup> In order to practice, Bach snuck into the woods near where he lived and found a cave. He practiced and hid his trumpet there while he was not using it.<sup>58</sup>

At the end of the summer, he entered engineering school where he gained scientific knowledge which would later help him in his mouthpiece and instrument manufacturing business. While attending school, Bach studied trumpet with George Stellwagen, Hartl's successor in the Vienna Tonkünstler Orchestra. He gained a local reputation as a trumpet player while he was in school, to his step-father's dismay. During this time, Bach switched from his original trumpet to a cornet, though it is not certain when this change actually took place.

After completing a year of required military service upon graduating, Bach took a job designing elevators in Vienna. He continued to perform on the cornet, which allowed him to earn double the amount of money the chief engineer at the elevator factory made.<sup>59</sup> He was offered a great contract for a concert series in England in 1912 and left his engineering job for it, much to his family's distress.<sup>60</sup> He was highly successful, but committed all his financial resources to his performances and lost them when he was recruited for the Turkish War in December 1912. He had to leave three days before the premiere with only his music, instrument, and the clothes he was wearing.<sup>61</sup> It was also around this time that he took the stage name Vincent Bach

---

<sup>57</sup> Fladmoe 1975, 29

<sup>58</sup> *Ibid.*, 29

<sup>59</sup> *Ibid.*, 32

<sup>60</sup> *Ibid.*, 32

<sup>61</sup> *Ibid.*, 33

because the English speaking world struggled with his given name; however his name was never legally changed.

In 1914, Bach returned to England, then left for the United States at the start of World War I, under the name of Peterson, with only five dollars and his Besson cornet.<sup>62</sup> His first jobs in New York were in vaudeville houses, which was very different from what he had done before. He became a member of the Boston Symphony for the 1914 and 1915 season but did not like the city of Boston.<sup>63</sup> In 1915, he performed at the San Francisco World's Fair, then returned to New York where he played first trumpet for the Metropolitan Opera's Ballet Orchestra and Opera Orchestra.

Bach was inducted into the United States Army in 1916 where he served as bandmaster of the 306<sup>th</sup> Field Artillery Band at Camp Union, Long Island.<sup>64</sup> Bach was frustrated by the lack of quality in instruments given to the band members. He also was enlisted as the head of the bugle school where he became further dismayed at the instrument quality, and even more dismayed at the state of the mouthpieces. He remodeled old mouthpieces and made new ones for the students at the Selmer Music Store in New York City where he had previously helped them sell instruments by demonstrating them in the store.<sup>65</sup> Soon, he was taking too much time at the lathe for the repair shop to do their job and was asked to stop, but his interest in this line of work was sparked.

When Bach left the service, he worked for Hugo Riesenfeld as the first trumpet and soloist with the Rivoli Theater, which provided him with a good income, but

---

<sup>62</sup> Smith 1994, 13

<sup>63</sup> Fladmoe 1975, 37

<sup>64</sup> Ibid., 39

<sup>65</sup> Ibid., 39



playing three shows a day in addition to solos was becoming increasingly difficult. He had ruined his mouthpiece in Pittsburgh, and had been searching for a replacement ever since, but had not found one to his liking. He experimented with those he found to be almost good enough but ended up ruining most of them. He purchased a lathe in 1918 on which he worked for about four to five hours day, producing one mouthpiece in that amount of time.<sup>66</sup> He made mouthpieces for some of his friends, and continued to make them for himself, with the goal of making a dozen for himself to sustain him for the rest of his musical career. His mouthpieces added a fifth to his range, and attracted the attention of other trumpet players who wanted to try them.<sup>67</sup> Bach's designs were based on that of Leopold August Schmitt, a Cologne-based mouthpiece designer.<sup>68</sup>

Bach sold all but three of his original twelve mouthpieces. Players offered up to fifty dollars for a mouthpiece, which was impressive because most mouthpieces at the time sold for about a dollar and fifty cents.<sup>69</sup> Bach had sold his equipment after making his twelve mouthpieces, but decided to start a mouthpiece making business. After his initial success, he rented a former junk shop in New York in 1919, and purchased a motor driven lathe. He was able to produce about five mouthpieces per week, which he sold for four dollars each.<sup>70</sup> He continued to perform at the Rivoli during this time.

Soon, Bach hired a helper to assist with the mouthpiece business and also hired a substitute to play at Rivoli so that he could spend more time at his shop and increase

---

<sup>66</sup> Fladmoe 1975, 41

<sup>67</sup> Ibid., 42

<sup>68</sup> Smith 1996, 22

<sup>69</sup> Fladmoe 1975, 42

<sup>70</sup> Ibid., 43

the mouthpiece output to twelve a day.<sup>71</sup> Bach mouthpieces were now used in the New York Philharmonic, the Boston Symphony, and the Metropolitan Opera Orchestra.

As demand continued to increase, Bach sought to develop tools which would allow him to produce mouthpieces of uniform sizes. He developed mouthpieces which were numbered according to their size, and was the first mouthpiece manufacturer to do so.<sup>72</sup> Previous to this, manufacturers named mouthpieces after celebrated artists, but exact sizing information was never given.

In 1921, Bach left his performance job at the Rivoli in order to fully devote his time to his business.<sup>73</sup> In the following year, Bach moved to a larger building, which allowed him to have two additional employees.

With mouthpiece sales going well, Bach turned his attention to trumpet and cornet design. In 1924, his first trumpets were produced, and though he was convinced of their superior quality, he had more difficulty selling them than the mouthpieces because no known artists were playing them at the time.

In 1925, Bach married Esther Staab, the daughter of a Kansas municipal bandmaster. In the next year, he was invited to return to playing in a temporary position at the new Roxy Theater. This allowed him to test his instruments in a real-world situation. He also did frequent radio broadcast performances, with his wife on piano, until 1930, and which helped greatly with business.<sup>74</sup>

In 1928, Bach added a trombone line to his manufacturing output, which necessitated a larger factory. He moved to a new New York factory, with about eight

---

<sup>71</sup> Fladmoe 1975, 45

<sup>72</sup> Ibid., 45

<sup>73</sup> Ibid., 46

<sup>74</sup> Ibid., 49

times the space the previous factory provided. Due to the Depression, Bach's wife took over the office duties and Bach did extra traveling to solicit sales. The factory also did an increased amount of repair work during this time. A large order from Russia in 1934 gave Bach's instruments an international reputation and offset his losses during the Depression. By the early 1940s, Bach had dealers in Europe, Asia, and South America, and the factory employed forty people on the factory floor and four in the office.<sup>75</sup>

World War II led to a shortage of raw materials used to make brass instruments. In fact, the production of musical instruments became prohibited, and many of the factory workers were drafted into the military.<sup>76</sup> The Bach plant primarily did repair work during this time, which was in higher demand because people could not purchase new instruments. When the war ended in 1945, Bach had to train new workers, and by 1949, Bach's plant was seeing similar success to what it had before the war.<sup>77</sup>

Bach became the president of the National Association of Band Instrument Manufacturers in 1950 and spent much of his time lobbying against cutbacks in materials imposed by the Korean conflict.<sup>78</sup> Bach's factory moved to Mount Vernon in 1953 where he continued to strive for higher quality and a greater degree of uniformity in the instruments.<sup>79</sup>

In 1961, the Vincent Bach Corporation became a division of the Selmer Company in Elkhart, Indiana.<sup>80</sup> This was due in part to the loss of his office manager and production manager who had run many of the operations of the company which

---

<sup>75</sup> Fladmoe 1975, 52

<sup>76</sup> Ibid., 52

<sup>77</sup> Ibid., 53

<sup>78</sup> Ibid., 54

<sup>79</sup> Ibid., 55

<sup>80</sup> Ibid., 56

allowed Bach to spend his time experimenting and developing designs. Also, by this time, Bach was almost completely deaf and worried that he would not be able to maintain his high standards of quality. Bach continued to work with Selmer training workmen and consulting in the development of instruments after the company was sold. Bach passed away on January 8, 1976.<sup>81</sup> He continued to be committed to his craft until his death.

### *Mouthpiece Design*

Before Bach's mouthpieces became popular, Schmitt mouthpieces, imported from Germany, were the prevailing mouthpiece used by American professional trumpet players. There were many inconsistencies with these mouthpieces, and Bach sought to create mouthpieces that were absolutely identical to other mouthpieces of the same model number.<sup>82</sup> He strove to create a large and varied line of standard mouthpieces in which at least one model would work well for any player without having to order a customized mouthpiece.<sup>83</sup> He produced a line of over 250 mouthpieces for brass instruments, numbered by cup diameter and depth.<sup>84</sup> He also offered a manual which detailed which types of players would benefit most from each mouthpiece. Even though he offered an enormous selection, he was willing to do further adjustments for players who wanted a larger throat or other adjustments.

Bach also standardized the taper of mouthpiece shanks and encouraged makers to standardize receivers to Morse standard taper #1. A Morse taper is recognized by the International Organization for Standardization as well as the German Institute for

---

<sup>81</sup> Smith 1995, 26

<sup>82</sup> Ibid., 10

<sup>83</sup> Fladmoe 1975, 147

<sup>84</sup> Ibid., 165

Standardization as a standard unit of measure. A Morse #1 tapers at a rate of .499” per inch. This standardization was in effort to make it easier for players to experiment with different equipment without worrying about whether or not the mouthpiece would fit into their trumpet.<sup>85</sup> Morse #1 tapers are still used in trumpet and mouthpiece design today.



**Standard Trumpet Mouthpiece:**  
Cross-section of a standard Bach trumpet mouthpiece, based on the original design created by master trumpet artist-engineer Vincent Bach.

**Figure 4 - Cross-section of Standard Bach Mouthpiece from the Bach Mouthpiece Manual<sup>86</sup>**

Bach was able to duplicate other mouthpieces for players upon request and if he found one which he liked, he continued to produce it as a part of his standard line.

In his mouthpiece manual, Bach suggests that professional trumpet players use a large mouthpiece for a broader tone, and employ correct use of the embouchure. He also advises against choosing a mouthpiece simply because a famous player or teacher plays it because each trumpet player is physically different.

---

<sup>85</sup> Fladmoe 1975, 167

<sup>86</sup> *Bach Mouthpiece Manual* 10

## **Renold Schilke**

### *Biography*

Renold Schilke was born in Green Bay, Wisconsin in 1910.<sup>87</sup> Schilke grew up in a musical family, and began his musical training on keyboard instruments. He began studying cornet at the age of eight. When he was nine years old, he studied with Del Wright, who had performed as a cornet soloist with the United States Marine Band before suffering a stroke, which paralyzed his right side and forced his retirement. He was inspired by Clarke, who performed on cornet and held the trumpet in contempt, and as a result, Schilke himself performed on cornet.<sup>88</sup>

At the age of eleven, Schilke performed with the Frank E. Holton factory band. He was allowed to observe the production of band instruments, and made his first trumpet in that year out of components he manufactured himself.<sup>89</sup> This interest in experimentation with instrument design continued throughout Schilke's life.

During high school, Schilke worked at a gunsmith shop part time and through this, he learned the basics of machining. He used that knowledge for his early experimentation with mouthpieces, and made many mouthpieces in the gun shop.<sup>90</sup> Schilke met Mike Getz during this time, and attributed much of his knowledge and understanding of mouthpiece design and the variables involved to Getz, who he regarded as "the principal mouthpiece expert for the Midwest."<sup>91</sup> His other primary influence in mouthpiece design was Schmitt.

---

<sup>87</sup> Fladmoe 1975, 87

<sup>88</sup> *Ibid.*, 89

<sup>89</sup> *Ibid.*, 89

<sup>90</sup> *Ibid.*, 90

<sup>91</sup> *Ibid.*, 91

In 1927, Schilke studied with Edward Llewellyn, the principal trumpeter of the Chicago Symphony, and briefly with Herbert L. Clarke.<sup>92</sup> At the end of the year, he moved to Brussels, Belgium to study with Eugene Foupeau. While in Brussels, he read a treatise on instrument design by Victor Mahillon. Mahillon's ideas about the effects of the rate of taper of the instrument were very influential in Schilke's instrument design.

He returned to the United States the following year and resumed studying with Llewellyn. He traveled with Llewellyn to the Holton Factory when he had his instruments modified and was able to continue to use these facilities for his own experiments. While in Chicago, Schilke performed regularly, often playing jazz and in dance bands.<sup>93</sup> He studied metallurgy and music at the University of Chicago and Northwestern University, and due to his expertise, Holton often asked him to solve problems in exchange for letting him use the factory.<sup>94</sup>

In 1929, Schilke played on a program for the Chicago Symphony, and became a member of the Chicago Civic Orchestra in the following year. It was in this ensemble that Schilke met Philip Farkas, who was interested in experimentation with French horn mouthpiece design. Due to other performing obligations, their contact was irregular, but they did share a close friendship which allowed for an exchange of ideas over the years.<sup>95</sup>

---

<sup>92</sup> Fladmoe 1975., 92

<sup>93</sup> Ibid., 94

<sup>94</sup> Ibid., 94

<sup>95</sup> Ibid., 96

Schilke studied with Max Schlossberg in 1933, and Georges Mager of the Boston Symphony in 1935.<sup>96</sup> 1933 was also the time that Schilke cites that he switched from playing primarily cornet to primarily trumpet, a change precipitated by the changing economy and the death of Sousa leading to a decline in the popularity of band music.<sup>97</sup>

He acquired a cornet mouthpiece from Mager which belonged to Arban. Through his career, Schilke collected many mouthpieces of famous brass performers and duplicated them. In 1936, Schilke married trombonist Alice Lowry. Beginning in the 1936 season, Schilke became a full-time member of the Chicago Symphony and remained until 1951, though he continued to perform with them whenever he was needed, until 1963.<sup>98</sup>

1936 also marks the year that Schilke began to manufacture mouthpieces commercially. His first line was in memory of Llewellyn, who had passed away that year. He produced copies of Llewellyn's mouthpieces and gave the profits to Llewellyn's widow to help offset the financial cost of her husband's death.<sup>99</sup> These designs were later rebranded as Schilke Model 9.

Schilke befriended Elden Benge, another trumpet player in the Chicago Symphony who was interested in experimenting with trumpet design. They often worked together in Schilke's home workshop.<sup>100</sup> In 1938, Benge was ready to form his own instrument manufacturing company and asked Schilke to assist him with tooling, which Schilke agreed to do. In the same year, Schilke was appointed to teach at

---

<sup>96</sup> Fladmoe 1975, 97

<sup>97</sup> Lewis 1980, 7

<sup>98</sup> Fladmoe 1975, 106

<sup>99</sup> Ibid., 98

<sup>100</sup> Ibid., 98



Northwestern and De Paul University, and was moved from third to second chair in the Chicago Symphony. In the next year, he taught at Roosevelt University (then the Chicago Symphony School of Music). He remained at Northwestern until 1954, De Paul until 1958, and Roosevelt until 1965.<sup>101</sup> Two of Schilke's most successful students were Vincent Cichowicz and Thomas Crown.

During World War II, Schilke's pay in the symphony was decreased and he found additional tool and die work, where he built firearms. He dropped out of the Chicago Symphony for the 1941-2 season because he was concerned that the defense work would take too much of his time to perform well. He returned to the symphony the following year after deciding that was not the case.

After the war, Schilke befriended Chicago Symphony tubist, Arnold Jacobs, and worked on tuba mouthpiece and instrument design for him. He and Jacobs experimented with mouthpieces until Jacobs was satisfied, after which Schilke offered the design for sale to the public.<sup>102</sup>

Farkas returned to the Chicago Symphony in 1947. By then Schilke's desire to experiment with mouthpiece design had increased. Together, the two men purchased a duplicating lathe which allowed Schilke to reproduce any mouthpiece more accurately than ever before, to a tolerance of a thousandth of an inch.<sup>103</sup> In the early 1950s, Farkas and Schilke were ready to go into business, operating from Schilke's home workshop. Schilke's original intention was to create one model of mouthpiece for each instrument and reproduce it in order to cut down on production costs. Player requests did not allow this to happen so he created a line of mouthpiece for each instrument instead.

---

<sup>101</sup> Fladmoe 1975, 99

<sup>102</sup> Ibid., 103

<sup>103</sup> Ibid., 104

As stated, Schilke left his full time position in the Chicago Symphony in 1951. Three years later, he began performing with the Chicago Lyric Opera where he stayed until 1964. He left when his mouthpiece business no longer allowed for a busy performance schedule.<sup>104</sup>

In the mid-1950s, Schilke began producing trumpets, and bought out Farkas, gaining full ownership of the company in 1956. Before he considered any instrument model successful, Schilke believed that much experimentation had to be done, and generally he went through numerous prototypes before the design was perfected. His primary goal was always to improve the intonation of the instrument. He used what he learned about intonation corrections to aid Farkas with the French horn line he developed for Holton.

The production of Schilke's instruments moved out of his home in 1959 because he feared the neighbors would have a problem with him conducting business in a residential zone.<sup>105</sup> The business moved again in 1963 in order to allow for expansion, this time to Evanston, then to Chicago's Loop in 1967.<sup>106</sup>

In the 1960s, Schilke worked with Dr. Willi Aebi, an acoustic physicist from Switzerland, in particular with visual scanning instruments including the oscilloscope.<sup>107</sup> He used this technology to further improve the intonation of his instruments. In the late 1960s, Schlike was asked to consult with Yamaha on their

---

<sup>104</sup> Fladmoe 1975, 106

<sup>105</sup> Ibid., 111

<sup>106</sup> Ibid., 112

<sup>107</sup> Ibid., 112

instruments, which he agreed to do. He continued to consult for Yamaha from 1966 until his death in 1982.<sup>108</sup>

### *Mouthpiece Design*

Schilke's backbore design was deeply influenced by the Schmitt Company in Cologne. Schilke believed that the backbore was the most important area of the mouthpiece and that Schmitt's design was the best on the market.<sup>109</sup> In the beginning, Schilke attempted to exactly duplicate Schmitt's design, but later employed the use of an oscilloscope in order to study wave patterns generated by mouthpieces, and altered the Schmitt design to produce what he believed to be a more desirable wave pattern.<sup>110</sup>

As with his instrument designs, much effort went into Schilke's mouthpiece designs in terms of intonation. Even so, he stated, "Often, the best mouthpiece is an intelligent compromise. Every teacher and player should strive for the optimum combination of the major variables."<sup>111</sup>

In addition to Schilke's standard line of trumpet mouthpieces, a custom series is also available. These offer variations on the Schmitt backbore and different shaped cups. Artist models are also available, such as the Faddis Model, which utilizes a heavyweight design.<sup>112</sup> Schilke also produced custom mouthpieces. This service is still available through the Schilke factory.

---

<sup>108</sup> Tarr, "Schilke, Renold O." *Grove Music Online*.

<sup>109</sup> Fladmoe 1975, 91

<sup>110</sup> Ibid.

<sup>111</sup> *Schilke Mouthpiece Catalog 2*

<sup>112</sup> *Schilke Mouthpiece Catalog 22*

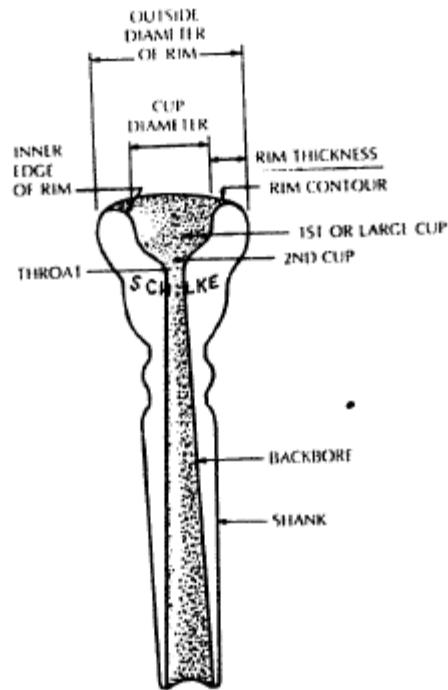

**Figure 5 – Schilke Mouthpiece**<sup>113</sup>

Like Bach, Schilke offered to duplicate existing mouthpieces. He used a duplicating lathe (which Bach did not have) in order to produce even more precise replicas. He was the only known American mouthpiece manufacturer with these capabilities from when he purchased the machine in 1927, until the early 1950s.<sup>114</sup> He used this process to duplicate the mouthpieces of many of the popular artists of the time, as well as from the past, including Llewellyn and Mager.<sup>115</sup>

Also like Bach, Schilke developed a line of standard mouthpieces in addition to his custom mouthpieces which were numbered systematically. This system was more consistent in sizing increments than Bach’s numbering system, and accounted for a

<sup>113</sup> White 1980, 30

<sup>114</sup> Fladmoe 1975, 169

<sup>115</sup> Ibid., 172

greater number of variables. Schilke also provided a mouthpiece manual with information on selecting the proper mouthpiece.

### **Robert Giardinelli**

#### *Biography*

Giardinelli was born in Sicily in 1914, the son of a music shop owner.<sup>116</sup> His mother passed away when he was five years old, and he was raised primarily by his older sister, Marie, while learning the basics of instrumental repair from his father. Giardinelli did not have formal instruction in music performance. He studied trumpet for about a year as a teenager and received some lessons in clarinet from his father.

He graduated from a regional school with an accounting degree, but never got a job in that field. He had attended at the request of his father, who wanted him to have additional income options besides instrumental repair. At the same time, he entered the Italian army, where he learned Morse code, before immigrating to the United States in 1939. When he arrived in the US, he took a job with Penzel and Muller, a clarinet manufacturing company in New York.<sup>117</sup> His desire to leave Sicily was in part due to the region's economic hardships following the Great Depression, and in part due to his sister's encouragement because she had moved to the United States before him.<sup>118</sup>

During World War II, Giardinelli was drafted for the military and served in Alaska as a radio operator in Morse code in 1942. After about two and a half years, he was transferred to Virginia where he trained others in Morse code, and met his wife

---

<sup>116</sup> Colin 1985, 3

<sup>117</sup> Ibid.

<sup>118</sup> Smith 1996, 18

whom he married, then divorced twenty years later.<sup>119</sup> Giardinelli returned to New York, where he opened an instrument repair shop in 1946 in the Bronx.<sup>120</sup>

His manufacturing began with clarinets due to the lack of quality imports.<sup>121</sup> He gradually stopped making clarinets because imports brought the prices of clarinets down. He began developing brass mouthpieces instead. Many of his developments were a result of trial and error experimentation. His shop moved to Tin Pan Alley which helped with his success because Giardinelli did not travel to do advertisement and relied on personal recommendations and word-of-mouth, as well as the strength of the quality of his products.<sup>122</sup> Much of his success was also due to the personal attention shown to everyone who entered his shop, which remained fairly small until 1965.<sup>123</sup>

When the company did expand, Giardinelli took great pride in the fact that his larger staff was highly skilled. After the expansion, the shop was able to do lacquering and plating in addition to its original repair work and mouthpiece production.<sup>124</sup> The shop was also able to stock a huge inventory of almost 4000 instruments at a time and this contributed to about 80% of its business.<sup>125</sup>

Giardinelli amassed a large collection of unique instruments and historical instruments, which he studied. He sold some of them once he was done studying them, while others he kept for the collection. He also created many mouthpieces for famous

---

<sup>119</sup> Smith 1996, 21

<sup>120</sup> Smith 1996, 13

<sup>121</sup> Colin 1985, 4

<sup>122</sup> Ibid., 7

<sup>123</sup> Teck 1985, 28

<sup>124</sup> Ibid., 29

<sup>125</sup> Teck 1985, 30

jazz trumpet players, including Louis Armstrong, and symphonic players including members of the New York Philharmonic and the Metropolitan Opera Orchestra.

During the last ten years of his business, Giardinelli produced 3000-4000 mouthpieces per year.<sup>126</sup> His good business sense, great service to customers, and excellent products made Giardinelli a millionaire. Robert Giardinelli retired in 1984 and passed away in 1996.<sup>127</sup>

### *Mouthpiece Design*

In his early years, Giardinelli experimented with existing mouthpieces which were brought to him by his customers. Through this experimentation and trial and error and the feedback of his professional clients, he learned what he needed to know to standardize his mouthpieces. He kept files of the specifications of each mouthpiece made, many of which had names of famous instrumentalists attached.<sup>128</sup> In this way a custom mouthpiece could be replicated if the artist lost it, or reproduced for a friend or another musician who requested the design or a variation upon it.

Giardinelli, working with trumpeter Joseph Shelpely, was the original creator of mouthpieces with three threaded interchangeable parts – the rim, bowl, and stem.<sup>129</sup> Schmitt had done work with mouthpieces with two interchangeable parts before him. Giardinelli created them in order to find the mouthpiece which suited individual players more easily. Being able to change individual components allowed greater accuracy in

---

<sup>126</sup> Smith 1996, 23

<sup>127</sup> Ibid., 14

<sup>128</sup> Ibid., 24

<sup>129</sup> Ibid., 23

satisfy each individual's tastes. Experimentation with three-part mouthpieces began in the early 1950s, but his design was not marketed until 1975.<sup>130</sup>

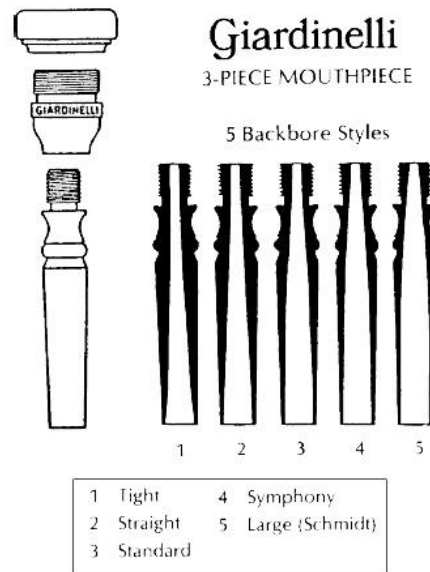

**Figure 6. Giardinelli Screw Rim Mouthpiece from 1975 Mouthpiece Catalogue<sup>131</sup>**

Vincent Bach recognized Giardinelli as his only other serious (mouthpiece) business rival in the 1950s.<sup>132</sup>

### **John Parduba**

#### *Biography*

In 1915, John Parduba began producing custom mouthpieces in his New York City Instrument repair shop. He began making instruments two years later.<sup>133</sup> Parduba designed the trumpet used by Harry Glanz from 1929 to 1940.<sup>134</sup>

He moved to a larger New York shop in the 1930s where he continued experimenting with mouthpiece design. He created the “double-cup” mouthpiece, which would

<sup>130</sup> Smith, 1996, 28

<sup>131</sup> Ibid., 23

<sup>132</sup> Ibid., 24

<sup>133</sup> John Parduba & Son

<sup>134</sup> Smith 1996, 32



become popular once Harry James began playing it. Harry James played exclusively on Parduba mouthpieces after this.<sup>135</sup>

Soon, many other top jazz players, including Louis Armstrong, Ray Anthony and Ziggy Elman, played Parduba double-cup mouthpieces. The mouthpieces were so successful that Parduba stopped doing repair work and making instruments so that he could focus completely on the mouthpieces.<sup>136</sup>

Parduba & Son Mouthpieces is now located in Arizona and is a division of Conn-Selmer.

### *Mouthpiece Design*

Parduba's most notable innovation was his double-cup design. This design utilizes a shallow upper cup in order to produce a brilliant sound and easier high notes with a longer, more conical lower cup to add richness in the middle and low register. This combination allows the player to produce a great tone throughout the range of the instrument with less effort than other mouthpieces, according to Parduba.

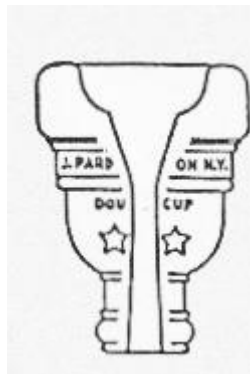

**Figure 7 - Parduba Double-Cup Mouthpiece<sup>137</sup>**

---

<sup>135</sup> Smith 1996, 32

<sup>136</sup> John Parduba & Son

<sup>137</sup> John Parduba & Son

## **Bob Reeves**

### *Biography*

Bob Reeves has an engineering degree from China Lake Naval Ordnance Test Station. While earning this degree, he worked as a toolmaker and apprentice experimental machinist.<sup>138</sup> During this time, he was also taking lessons to be a trumpet player, and was encouraged by his teachers to experiment with mouthpiece and instrument design. On the recommendation of his teacher, John Clyman, Reeves worked with Carroll Purviance and learned much about mouthpiece design.

At first, Purviance worked with the clients and Reeves worked where he excelled: the machining of the mouthpieces. When Reeves started working with players as Purviance became unable to do so, he realized that he didn't know exactly how to help them and interpret their needs. He learned that all aspects of the mouthpiece are critical, and through one-on-one work with the player, a mouthpiece can be adjusted to suit his or her individual needs.

Reeves also worked for the Eldon Benge Company for ten years, three of which overlapped with his time with Purviance. At Benge, Reeves worked on all parts of the trumpet, not just the mouthpiece. These experiences led him to create his own mouthpiece and repair business in 1968. In addition to designing mouthpieces, Bob Reeves is also known for his valve alignments, which he considers very important in relation to the choice of mouthpiece.

Reeves suggests that most players select a mouthpiece using an instrument with an improper valve alignment. Because of this, these players select mouthpieces that are large, in order to feel comfortable, but these larger mouthpieces are more difficult to

---

<sup>138</sup> Bob Reeves Brass Mouthpieces

play. A proper alignment should allow the player to use a more efficient mouthpiece. When Reeves does a valve alignment, he installs new valve pads that will not wear down and compress like the felt or rubber pads included with most trumpets. He then adjusts the instrument to be perfectly aligned with these new pads.

### *Mouthpiece Design*

One aspect of the mouthpiece Reeves believes is extremely important is the gap. Reeves offers removable sleeves which allow players to experiment with the gap to find its optimal measurement. Through experimentation, he and found that players can perceive an adjustment of a 32<sup>nd</sup> of an inch in the gap.<sup>139</sup>

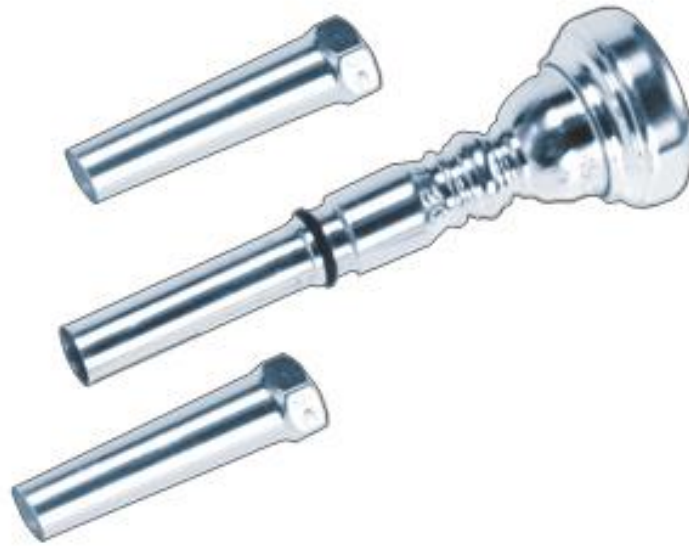

**Figure 8 - Reeves Sleeves<sup>140</sup>**

Reeves produces mouthpieces that are based on his work with Purviance in his Purviance Series, and provides customers with the original Purviance numbers as well as models with the numbers according to his own numbering system. He manufactures

---

<sup>139</sup> Bob Reeves Brass Mouthpieces

<sup>140</sup> Ibid.

them with a standard gap, as well as with a ‘B’ shank, which decreases the gap, in addition to the option of removable sleeves.

A Classical Series is also available for orchestral players. The design of the cups and rims of these mouthpieces is based on Mount Vernon Bach and other vintage mouthpieces, while the backbore is designed by Reeves to allow better intonation and consistency in all registers.

The C2J Series are designed for those wanting a dark, flugelhorn-like sound on their trumpet. This is primarily used by jazz players for playing ballads, or orchestral players who need very dark sounds or who are working with a choir.<sup>141</sup>

Reeves also offers several rim, cup, and backbore options in his Standard Series. Custom Mouthpieces can also be ordered and created for individual needs. Reeves can also duplicate any existing mouthpiece.

## **Gary Radtke**

### *Biography*

Gary Radtke earned a Bachelor of Music Education degree at the University of Wisconsin-Oshkosh with trumpet as his major instrument. After he graduated, Radtke toured, backing up big-name players. He has worked as a high school band director as well. Radtke also has 35 years of experience in design, manufacturing, and tool building.

Radtke started GR Technologies in 1999 with Brian Scriver. Both were searching for solutions to playing difficulties. In Radtke’s case, he was searching for a mouthpiece that would allow him to play well after a dental reconstruction. GR’s goal

---

<sup>141</sup> Bob Reeves Brass Mouthpieces

is to help trumpet players find equipment that enables them to solve playing problems and focus on making music.

### *Mouthpiece Design*

GR Technologies coined the term “alpha angle” to describe the area of the mouthpiece between the rim and the first cup radius. Every mouthpiece has an alpha angle, but GR is the first company to define it mathematically.

GR also uses the term “beta angle” to describe the curve of the cup. What is typically described as a V-shaped cup could be described as a cup with a lower beta angle. A C-shaped cup is another name for a cup with a high beta angle.

Mathematics is used in all parts of the GR mouthpieces in order to assure that the mouthpieces are well balanced. The mouthpieces are “Compu-Balanced.” This means that the connection from one constituent part of the mouthpiece to the next (i.e. the rim to the cup) is perfect. All of the calculations insure that there are no discontinuities in the design. Options include hundreds of standard models and thousands of custom designs in order to suit the needs of the majority of players.

### **David Monette**

#### *Biography*

David Monette was contacted about participation in this study, but declined. He began his musical life as a trumpet player and musical instrument repairman.<sup>142</sup> Monette began designing trumpets in 1983, after being frustrated with the inconsistencies found in conventional equipment.<sup>143</sup> He recognized that he would have to also redesign the trumpet mouthpiece in order to achieve the results he was striving

---

<sup>142</sup> Irish 2012, 15

<sup>143</sup> David G. Monette Corporation.

toward. The research of Dr. Arthur Benade convinced Monette that a mouthpiece for each given key of trumpet would be needed in order to provide the constant pitch center, improved flexibility, greater endurance, and better response he was seeking.<sup>144</sup>

In 1985, Monette made his first mouthpieces, which were used by such players as Charles Schlueter and Wynton Marsalis. His goal was to improve intonation and provide a constant pitch center. He also began studying the Alexander Technique<sup>145</sup> and Kundalini Yoga<sup>146</sup> during this time in order to gain the ability to become objectively aware of the way his own body compensates for the problems with conventional equipment.<sup>147</sup> He cites this as a very important point in the development of his mouthpieces, and believes that his designs have improved drastically because of it.

In 1990, Monette began selling his mouthpiece to the general public, whereas prior to that, only his instrument clients had been able to buy them. Since then, the line has expanded to include mouthpieces for high trumpets, tubas, and trombones. Monette uses state of the art computer technology to create mouthpieces and instruments with greater precision than ever before.

Many of Monette's recent trumpet designs incorporate integrated mouthpieces designed specifically for the trumpet and trumpeter. An integrated mouthpiece is built into the trumpet itself (see the figure below). Trumpet players using a Monette trumpet

---

<sup>144</sup> David G. Monette Corporation

<sup>145</sup> The Alexander Technique is a method used in order to improve posture and coordination, as well as relieve tension. It involves learning to become aware of individual habits which inhibit the way the body is naturally intended to work. The Alexander Technique is used frequently by musicians, dancers, and athletes.

<sup>146</sup> Kundalini Yoga is a yoga style which combines physical exercises, breathing techniques, and meditation. It focuses strongly on allowing the practitioner to become increasingly self-aware. Meditation is not separate from physical practice, but is considered an integral part to all that is done in the practice.

<sup>147</sup> David G. Monette Corporation

with an integrated mouthpiece include Wynton Marsalis<sup>148</sup>, Terence Blanchard<sup>149</sup>, and others. Presently, integrated mouthpiece designs are not a development that has been explored by other manufacturers.



**Figure 9 - Monette RAJA with Integrated Mouthpiece<sup>150</sup>**

#### *Mouthpiece Design*

Monette mouthpieces are available as standard models or “PRANA” models. The standard line is constructed with classic tooling, while the PRANA line is built using cutting edge technology. The exact differences in the way these mouthpieces are built are trade secrets which Monette does not disclose. Monette strongly advises against altering the throat or any other aspect of his mouthpieces. He will do custom work for clients if it is requested.

Monette has recently introduced a “SLAP” mouthpiece. The SLAP mouthpiece has a cup shape which is more S-shaped than a standard mouthpiece when looking at a

---

<sup>148</sup> Wynton Marsalis is an internationally acclaimed jazz and classical trumpet soloist. He has won nine Grammy Awards and is the only artist to have won Grammy Awards for both classical and jazz recordings.

<sup>149</sup> Terence Blanchard has won five Grammy Awards as a jazz soloist. He is also known as a jazz composer, arranger, film composer, and bandleader.

<sup>150</sup> David G. Monette Corporation

cross-section of the mouthpiece. The cup is designed to give the player a bigger sound, more percussive articulation, faster response, and make slotting easier. Like many manufacturers, Monette designs lead mouthpieces with shallower cups than his mouthpiece intended for symphonic players.

The throat of a Monette mouthpiece varies in size based on model and the key of the trumpet with which it is designed to be used. All of the throat sizes are larger than that of traditional mouthpieces. Monette believes that a larger throat, in combination with his other design concepts, contributes to the mouthpiece's ability to provide a constant pitch center.<sup>151</sup>

The length of the exterior shank of a Monette mouthpiece is shorter than that of a standard mouthpiece, as is the shank size. Both of these factors affect the gap. The shank size is gradually reduced as the end of the mouthpiece is approached. This leads to a reduction in the gap created between the end of the mouthpiece and the beginning of the leadpipe venturi.<sup>152</sup>

All Monette mouthpieces are plated in gold because Monette believes that this material is more comfortable. He also believes that it provides better protection for the mouthpiece than traditional silver and it tends to hold moisture better.

Monette mouthpieces work best when players perform in a relaxed way in order to achieve maximum resonance. Many players find that they are able to push their tuning slides in further when playing in this way. Monette also emphasizes the importance of using proper posture which allows the throat to be relaxed and open.

---

<sup>151</sup> David G. Monette Corporation

<sup>152</sup> Koehler 2007, 25



All Monette mouthpieces are designed with the goal of improving intonation and providing a constant pitch center, regardless of dynamic level or range.

Mouthpieces are designed specifically for the key and weight of the trumpet. A trumpet player is advised to buy both a C and B-flat mouthpiece to use on the separate trumpets. This way, the pitch center, intonation, and other aspects which Monette mouthpieces are designed to improve match with the instrument being used.

Standard Monette mouthpieces tend to be heavier in weight than conventional mouthpieces. This weight is needed in order to complement and balance the instrument.<sup>153</sup> Monette mouthpieces which are designed specifically for heavy Monette trumpets are heavier than those designed for standard trumpets. Lead trumpet mouthpieces are heavier than standard lead trumpet mouthpieces, but lighter than standard Monette mouthpieces.

A Monette mouthpiece is designed to produce a brilliant, resonant sound. This should not be confused with a bright sound, which contains more highs than lows. A sound that is too dark does not have clarity in the pitch center and comes across as dull. Either of these problems makes it difficult for the trumpet to project. Monette's design seeks a way to balance these attributes, providing the player with maximum resonance when played with the proper, relaxed approach.

---

<sup>153</sup> David G. Monette Corporation

## Chapter 3: Interviews with Modern Makers

### Asymmetric Mouthpieces

#### *Overview of Company*

Asymmetric mouthpieces were patented in 1994 by John Lynch. As a trumpet player, Lynch performed extensively between 1973 and 1980 and continued to perform professionally off and on after that time. Lynch is also a nuclear physicist, and worked at NASA as an engineer and consultant. His areas of technical interest include nuclear reactor physics, heat transfer, statistics, and mathematics. Lynch applied the analytical and experimental methods he used as a physicist and engineer to the problems associated with trumpet mouthpieces. This research was undertaken during a time that Lynch was performing almost every night, but he persevered and was able to develop the Asymmetric mouthpiece without any outside assistance in terms of design, as well as running the business (known as Asymmetric), and obtaining the patent.

Lynch also wrote a book, *A New Approach to Altissimo Trumpet Playing*, in which he uses his knowledge in physics and trumpet performance to prescribe exercises that optimize efficiency and range. Maynard Ferguson's reaction was, "Extremely well done, very informative, I would not hesitate to recommend this book at any time."<sup>154</sup> He was also published in the *International Trumpet Guild Journal*. An article about his Asymmetric mouthpieces can be found in the February 1996 issue.

---

<sup>154</sup> The New Asymmetric – Range Enhancing Trumpet Mouthpieces.

### *Interview*

The interview with John Lynch was conducted on April 10, 2014 via telephone at 1:00pm CST. The interview was based on a list of questions provided to Mr. Lynch in an email prior to the interview (Appendix A).

The first item on the questionnaire asks Lynch to break the mouthpiece into its constituent parts and describe the function of each. We began by discussing what makes the Asymmetric mouthpiece design unique, which is the cup and rim design.

Lynch's background research while he was creating the Asymmetric mouthpiece included a report published in the Journal of the Acoustical Society of America in July of 1942 by Hayward W. Henderson, a researcher at the Peabody Conservatory. Henderson gives evidence that trumpet tones are produced when the player's upper lip vibrates against a relatively fixed lower lip. He also showed that the main function of the lower lip is to control the rate of vibration, which generates the pitch.

As a trumpeter ascends in the register, the bottom lip compresses upward against the top lip. This upward compression reduces the mobility of the upper lip which reduces the effective vibrating mass. The reduction in mass available to vibrate allows the frequency of the vibrations to increase, and thus the range as well.

The Asymmetric mouthpiece is designed with additional metal in the lower part of the rim and cup when orientated correctly as shown in the figure below. This metal is added to give extra support to the lower lip which tends to bulge outward (forward) when a trumpeter uses a radially symmetric mouthpiece. Instead of bulging outward, the lip bulges upward which assists with the compression described above. This leads to an increase in range as well as better endurance. The rim of the Asymmetric

mouthpiece is mostly flat. This further assists the trumpet player's ease in the upper register.



**Figure 10 - Asymmetric Mouthpiece<sup>155</sup>**

The Asymmetric mouthpiece is similar to other mouthpieces in that it has a shank, throat, and backbore. These design elements are familiar to all trumpet players, but the Asymmetric mouthpiece's cup cavity and rim, which are both highly three dimensional, cannot be analyzed by any two dimensional conventional analysis as is routinely performed for all other mouthpieces. It is more sophisticated mathematically and requires a much more sophisticated model.

The cup of the Asymmetric mouthpiece was designed with the intent to increase range and endurance as well as the ease of playing in the upper register. Lynch used statistical inference in order to optimize the design. Statistical inference is a mathematical process of drawing conclusions from a data set based on prior research combined with experimental results. Because of the fact that there is no record of

---

<sup>155</sup> Image used with John Lynch's permission

anyone using this approach before him, it can be assumed that Lynch was the first to do this.

Lynch's first assumption was that the inside of the cup could be described by an infinite series. An infinite series is a set containing an infinite amount of data points which approach a given number (the limit). Lynch created a response function for the inside of the cup using this infinite series. If an element is added to or taken away from a system, the response function can predict what change in the system as a whole will occur. The creation of this response function for the Asymmetric mouthpiece was a very labor intensive process. The cup was made based on the response function and was extremely successful at enhancing the areas it was designed to enhance: range and endurance.

The next element we discussed was the alpha angle. This is a descriptive term developed by Gary Radtke of GR Mouthpieces. It does not have a practical application in Lynch's design.

The throat is an important part of the mouthpiece design. All of the Asymmetric trumpet mouthpieces have a #25 throat (0.150 inches). Some trumpeters play as large of a throat as #19 while others play as small as #27. A #25 throat is a size that works well for most players in combination with the Asymmetric cup and rim designs.

Asymmetric mouthpieces use two different types of backbores. The Opera, which is the symphonic design, uses a Schmitt #2 backbore. The cylindrical section of the Schmitt backbore flares quickly for a short period directly after the throat of the mouthpiece before evening out to a much more gradual flare. The LEAD mouthpiece

uses a backbore created with a straight four degree reamer. This assists in giving the lead player a brilliant, cutting sound.

The external shank taper of the Asymmetric mouthpiece is a Morse #1 taper. This taper is the industry standard used on all trumpet mouthpieces and was introduced by Vincent Bach. The overall length of the mouthpiece is the standard size. There is no variability in length among Asymmetric trumpet mouthpiece models.

The second item on the questionnaire invited a discussion about the venturi, gap, material used to make the mouthpiece, and plating. The venturi was discussed above due to the fact that the throat and venturi can be used to describe the same thing. A #25 throat is used for all Asymmetric mouthpieces. This throat is more open than many lead mouthpieces. This helps the trumpeter produce a bigger sound. Because the rim and cup design allow the player to play higher with greater ease, the throat can be more open without sacrificing endurance or intonation.

We discussed the gap next. Lynch pointed out the fact that there are many varying opinions about what the gap adjustment does and whether or not this is necessary. The gap causes the air pressure to drop as the air passes through the section of the tube that is suddenly larger. When it recovers back to its original state, there is another pressure drop. This is why changing the gap can be said to change playing characteristics. There are some players who can detect a difference when a minor adjustment in the gap is made, but for most it is not an issue. Changing the gap causes only a negligible change which most players do not notice.

The material from which a mouthpiece is made was discussed next. All of the Asymmetric mouthpieces are made of brass, like traditional mouthpieces. Plastic

mouthpieces are not offered in Asymmetric form because there are very few players who use plastic mouthpieces. There are other manufacturers who make mouthpieces out of stainless steel, but research studies have shown that the type of metal used makes no discernable difference in the playing or sound characteristics.

Asymmetric mouthpieces are composed of brass and then plated in silver. The silver has been shown in a study to possess a quality that prevents bacteria from living on it. Silver plating is also less expensive than gold plating, which keeps the cost of the mouthpiece down for the manufacturer and the buyer.

The third question asks if design considerations are made when designing mouthpieces for B-flat versus C trumpet. Asymmetric mouthpieces are made primarily for B-flat trumpets. As of right now, the design is the same for C and B-flat trumpet. When designing a mouthpiece, the only dimension that must be preserved is how far it sticks out of the instrument. An allowance may be made for tuning, but further research would have to be done to verify what this allowance would be. At this time, Asymmetric mouthpieces work on both B-flat and C trumpets, but were originally designed and play-tested on the B-flat trumpet.

The next question addresses the difference in design concept for the orchestral versus the commercial trumpet player. The design of the Asymmetric mouthpiece began with the lead trumpet player as the intended user because Lynch's performance area of expertise is with big bands. The LEAD line of Asymmetric mouthpieces is designed for primarily commercial players. LEAD mouthpieces are designed to give a full and brilliant sound with cutting power. The backbore is straight, which enhances the lower register, and provides a bigger sound in the upper register. The Asymmetric

rim and cup design allow the mouthpiece to go up to a double C (C6) without acoustic problems.

Classical players usually desire a sound with a little less edge to it. The Opera series of Asymmetric mouthpieces is designed with a #2 Schmitt style backbore and deeper cup in order to achieve the darker sound symphonic players desire. The Asymmetric rim and cup shape provide better endurance and range for the orchestral player, while the desired sound is achieved with the deeper cup and Schmitt backbore. Physical weight is added to the mouthpiece, which also darkens the sound and improves slotting.

Lynch suggests that the majority of Asymmetric mouthpieces purchased are for commercial trumpet players because there are more professional opportunities for the commercial musician with symphonies closing all over the country. There is also a market for crossover players.

Lynch developed a mouthpiece called the 3C plus 544 which is ideal for the trumpeter who plays both classical and commercial music. It is designed to possess playing characteristics in between the LEAD series and the Opera series. The name of the mouthpiece is associated with the good intonation and ease of playing that many trumpet players connect to the Bach 3C mouthpiece. Because it uses the Asymmetric design, Lynch believes the endurance is improved over a Bach 3C, as is the range and ease of playing in the upper register.

The next question asks if design innovations in modern trumpets affect mouthpiece design concepts. This was not a consideration when making the Asymmetric mouthpiece.



The final question asks for a statement as to how the design concepts used in the creation of this mouthpiece improve upon traditional mouthpieces. There is an enormous difference between this mouthpiece and the radially symmetrical mouthpieces made before it. In Lynch's view, Asymmetric mouthpiece makes a huge difference in a person's range and makes it easier to play in the upper register. In radially symmetrical mouthpieces, there is a huge variety in backbore shapes and cup depth, whereas there is a limited selection of Asymmetric mouthpiece options. The options that are available work well for most players.

Lynch added that unlike radially symmetrical mouthpieces, the player must orientate his mouthpiece in a specific way with the extra metal on the lower lip. He believes that for this mouthpiece to work in this configuration, the trumpeter must be an upstream player. This means that about two thirds of the mouthpiece is placed on the bottom lip and one third is placed on the top lip which causes the airstream to be directed upward, into the cup. A downstream player puts the mouthpiece approximately evenly on the top and bottom lips. Lynch advises prospective lead players to become upstream players. The initial concept of the mouthpiece was based on upstream playing.

Some downstream players have found that they are able to use the Asymmetric mouthpiece when it is inverted with the extra metal on the top lip. Lynch described an experience a friend of his had meeting Maurice Andre on an airplane, which led to Andre showing this friend the mouthpiece he uses. Andre's mouthpiece at this time was asymmetrical and conceptually the same as Lynch's design, though not identical to it. Andre played with the wider part of his asymmetric mouthpiece on the upper lip.

This is proof that a downstream player can successfully play an Asymmetric-like mouthpiece with the wider part on top and achieve the desired effect of the mouthpiece.

Lynch also added that the trumpeter can only play to high G (G6) and have the trumpet acoustically function as a trumpet. When a note is produced, a pressure wave occurs which is reflected back to the embouchure at a specific point within the bell of the trumpet. This point moves outward as the trumpeter moves up the range of the instrument. Once the trumpeter reaches G above high C (G6), the point of reflection moves outside the bell. This means that there is no longer a reverse pressure wave and that the sound is being produced only as a result of the lip vibration. Because of this, it takes significantly more air to play above G6. The Asymmetric mouthpiece is designed assist the embouchure in creating higher frequency vibrations. This makes it easier to play notes above the typical G6 barrier.

## **Curry Mouthpieces**

### *Overview of Company*

Curry Precision Mouthpieces was started by Mark Curry in 1989. The first products were the Sound Sleeves and heavy valve CCAPS still popular today. His first trumpet mouthpiece models appeared in 1993. Curry began listening to players such as Bill Chase and Maynard Ferguson as well as Clifford Brown and Harry James at an early age. He listened to the different sounds these and other players were able to produce. At the age of 14 or 15, Curry began experimenting with modifying his mouthpieces using an electric drill and a steak knife.

Curry's first true custom mouthpiece was made for him by Phil Warsip at the Schilke shop on Wabash Avenue in Chicago, Illinois, which was later taken over by

Scott Laskey. At the time in the Schilke shop, a tracing lathe was used to design the mouthpieces. Curry was fascinated by this and created his first custom designs through Schilke.

Curry earned a Bachelor's degree in trumpet performance at the University of Illinois under Ray Sasaki and David Hickman (1978). He later earned a Master's degree in trumpet performance at the University of Nevada, Reno under Larry Engstrom (1998). Ray Sasaki is an excellent jazz and classical player, and explores new music which employs extended techniques. Curry learned to play in all styles through his study with Sasaki. After he graduated, he played lead trumpet in the summer of 1982 with the Woody Herman Band, then moved to Las Vegas.

Upon arrival in Las Vegas, Curry played with various reading bands at the Musicians' Union while waiting out the six months necessary to get his union card. During this time he auditioned and won the lead trumpet chair for Ray Charles. He toured worldwide with Ray Charles for almost six years straight and also returned to sub occasionally until Ray's death in 2003. During that time, Curry was playing on Warburton mouthpieces. With the advent of computer lathes, Curry began to experiment with creating his own mouthpiece designs. The Computer numerical controlled (CNC) machines allowed mouthpieces to be created and duplicated extremely precisely. Presently, Curry continues to perform on trumpet in the Reno area and designs and sells mouthpieces.

## *Interview*

The interview with Mark Curry was conducted on April 11, 2014 via telephone at 1pm CST. The interview was based on a list of questions provided in an email prior to the interview (Appendix A).

The first item on the questionnaire asks Curry to discuss the function of each constituent part of the mouthpiece in accordance with his design concepts. We talked about the rim first. The rim is the interface between the trumpet and the player. Some players are very dependent on the rim being a specific diameter. The rim must accommodate the player's mouth, teeth, and lips, while allowing the player to perform as needed.

Curry digitally scanned the most popular rim designs from Mount Vernon Bach mouthpieces. In the Mount Vernon Bach mouthpiece line, rims range from flat to round, and from wide to narrow. Curry uses the most popular rims from the Mount Vernon mouthpiece line and adapts them to be used with his cups. Each rim diameter and contour is unique but remains constant, allowing the same rim feel for the player whether playing trumpet, cornet, or flugelhorn.

In terms of sound, the cup is the most important variable. A deeper bowl-shaped cup generally accentuates the fundamental pitch, which creates a dark, warm sound. A flatter, shallower cup emphasizes the higher harmonics, creating a brighter, more present sound. Curry offers several cup designs to meet players' needs.

In the past, manufacturers used many different kinds of form tools and shapers to make mouthpiece cups. Today, CAD/CAM software coupled with high precision Computer numerical controlled (CNC) lathes now allow manufacturers the flexibility to

design and produce nearly any style cup and rim with more precision than ever before. CNC lathes use carbide tooling to automatically create designs which have been programmed into machine under the supervisor of a knowledgeable operator.

We discussed the alpha angle next. The alpha angle occurs directly under the bite radius, which is the inner diameter of the mouthpiece that contacts the lips. That angle determines how much lip engagement goes into the cup. It also helps define a release point for the lips, which is the point at which the lips no longer touch the mouthpiece. A very high alpha angle, which is a very steep undercut, allows the lips to vibrate very freely. The low alpha angle, which is a soft undercut, can impede the lips from vibrating for some players.

The alpha angle is relevant in all types of mouthpieces. Loosely speaking, trumpet cups can be grouped into two categories: a “true radius” cup and an “L-style” cup in which the bite radius interfaces with a straight section before the concave cup section of the piece. The “true radius” cup may not have the straight line which GR defines as the alpha angle; however the concept does still apply. An L-style cup, such as Curry’s 3C, does incorporate a straight section which makes the alpha angle very easy to calculate, while his 1.25C, 5C, and 7C cups incorporate the radius style cup. It is more difficult to estimate the alpha angle on the mouthpieces with true radius cups.

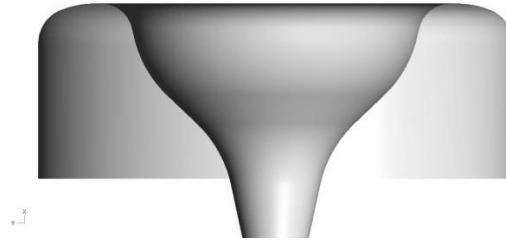

**Figure 11 - Curry L-Style Cup (3C)<sup>156</sup>**

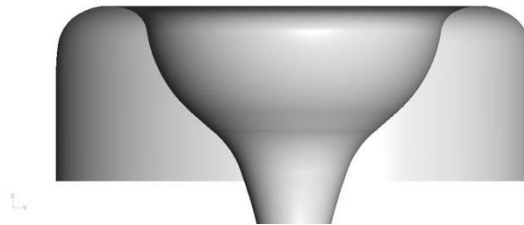

**Figure 12 - Curry True Radius Cup (1.25C)**

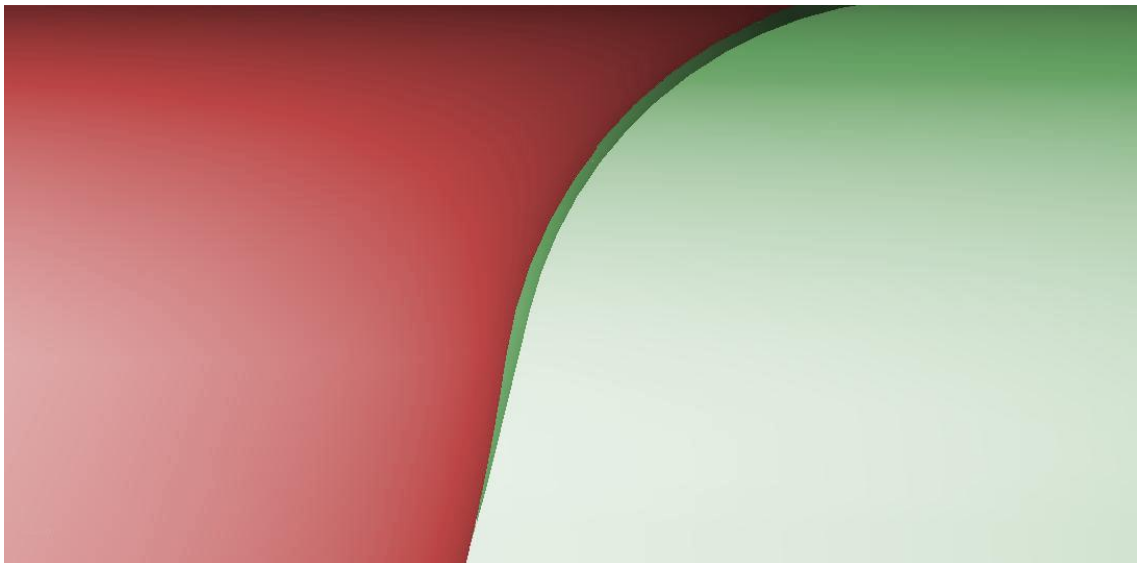

**Figure 13 - Curry Zoomed Comparison True Radius vs L-Style<sup>157</sup>**  
(Red represents the interior volume of the True Radius cup. Green represents the difference in interior volume between the two cups. The lighter section represents the metal of the mouthpiece.)

<sup>156</sup> Images in Figures 10-11 used with Mark Curry's permission

<sup>157</sup> Images combined by the author and used with Mark Curry's permission

The next item on the list is the throat. Many people tend to gravitate toward what has worked for them in the past. The #27 throat is common among mouthpiece manufacturers, and many people like it because they are used to it. Curry offers throats ranging from #28 to #24 on his trumpet mouthpieces, and this works for about 95% of all players.

The backbore serves two functions. The first is to shape the sound. A narrow tapered backbore emphasizes the upper harmonics, while a large curved Schmitt style backbore tends to produce a darker sound. In terms of playing, the backbore also serves to balance the blow of the cup. A slight change in the backbore can work better for players who want a freer blow than drilling out the throat. Players gravitate toward a balance that they believe has worked best for them over the years.

The next item we discussed was the exterior shank taper. The shank taper on Curry mouthpiece is .050" per inch. This is what most modern manufacturers are using. People mistakenly call it Morse #1. It is extremely close, but it is not truly a Morse #1 taper, which is .04988" per inch, and has very specific large and small end diameters. It is terminology that has been used over the years and kept. Older Conn cornets used a .060" per inch taper before the 700,000 serial numbers, which was before 1958.<sup>158</sup> Some of the German-made and older historical mouthpiece tapers are a little bit different as well, but almost every mouthpiece made in the past forty or fifty years is going to fit most trumpets. The shank taper helps to define the gap, which will be discussed in the second question.

---

<sup>158</sup> Conn-Selmer

The overall length of original Bach trumpet mouthpieces was  $3 \frac{7}{16}$  inches. Renold Schilke designed his trumpets for a  $3 \frac{1}{2}$  inch mouthpiece. Monette designs his mouthpieces at 3.14 inches. Certain trumpets sound best with certain length mouthpieces. This is probably why Monette mouthpieces sound the best in Monette trumpets. Bach and Schilke mouthpieces are relatively interchangeable, though Scott Laskey asserts that Schilke mouthpieces sound fine in a Bach trumpet, but Bach mouthpieces do not sound as good in a Schilke trumpet. This is because of a difference in overall length. Curry believes that having a mouthpiece length that matches with the trumpet is important as it helps to line up and define the trumpet's harmonic series.

The second question asks Curry to discuss the importance and function of the venturi, gap, material from which the mouthpiece is made, and plating. The venturi can also be described as the exit diameter of the mouthpiece which leads into the leadpipe. The venturi can affect resistance, intonation, and sound quality. Some early mouthpieces had a small venturi, but this was countered by a huge throat, which tend to produce an airy sound on most Bb trumpets.

The relationship between the mouthpiece venturi and the leadpipe venturi is definitely an area that needs further research. The ideal exit diameter of the end of the mouthpiece should be relatively close to the diameter of the leadpipe venturi. The gap falls in between. There tends to be much more resonance in the sound when the mouthpiece exit venturi and the leadpipe venturi are close in diameter. When the exit diameter of the mouthpiece is too large, the trumpet can sound tubby and some control is lost. When it is too small, the sound has a tendency to become airy. This discussion led us to the subject of the gap.



The ideal gap varies from player to player and from trumpet to trumpet. Some players do not notice the gap very much, choose not to give attention to it, and compensate for it with their playing technique. However, going through the effort to find the ideal gap can make a huge difference for some players. Many factors can change the gap. A receiver could become worn due to a player screwing the mouthpiece into the receiver too firmly. The receiver and mouthpiece are both made of brass and brass can eventually compress, allowing the mouthpiece gap to become smaller, sometimes non-existent, with the mouthpiece bottoming out on the leadpipe. The gap can vary for these reasons. A few trumpet manufacturers have come out with adjustable receivers which can help alleviate this problem.

In order to accommodate the gap, Curry recommends custom diameter one-piece mouthpieces. Most of Curry's standard line of mouthpieces has a .383 inch exit diameter, which produces a gap similar to a Reeves #5 Sleeve. This works well for most trumpet players and most trumpets, but custom diameters can be machined as well. Curry will also cut a mouthpiece for Reeves Sleeves if desired, but emphasizes that shank diameter is of prime importance when manufacturing his mouthpieces.

The next part of the question addresses the material from which the mouthpiece is made, and its effects on the playing characteristics of the mouthpiece. Curry believes that brass is the ideal material, though manufacturers have experimented with many different materials. There have been wooden mouthpieces and mouthpiece tops, injection molded polycarbonate mouthpieces, ceramic mouthpieces, and stainless steel mouthpieces. There is definitely a difference in the way sound is transmitted among all

of these materials. This is not necessarily good or bad. Brass remains the most suitable material because it is the easiest to machine.

The vast majority of Curry mouthpieces are made of brass, though copper and nickel silver, as well as stainless steel have been used. The nickel silver is extremely difficult to machine. Copper is soft, but it is very stringy which also leads to manufacturing problems. Curry has also made trumpet tops out of stainless steel. These stainless steel tops must be machined about 70% slower than a standard brass mouthpiece. Brass is easy to acquire, easy to work with, and produces a great trumpet sound. Like most manufacturers, Curry uses Brass C360, an alloy which is easy to machine but contains a little bit of lead and must be plated.

Most Curry mouthpieces are plated in silver. Silver is generally recognized as a safe metal, free of toxic trace elements. Some people's body chemistry causes silver to corrode. If this problem occurs, a good option is gold plating. Gold is one of the least reactive materials on the planet. It has to be electroplated over a less noble metal to adhere and bond properly. For this reason, mouthpieces are usually plated first in silver, then in gold.

Nickel plating produces a beautifully smooth finish, but is very brittle. Some early Denis Wick mouthpieces were nickel plated, then gold or silver plated on top of the nickel. If the mouthpiece was kept in pristine condition, this would not cause a problem. However, any nicks, dents, or scratches would compress the underlying brass and fracture the Nickel plate, creating a pocket of air which will eventually collect saliva and other substances. This will cause the plating to flake off.

For players who are allergic to all of the above metals, polymer mouthpieces or screw-rims in Delrin or Lexan are an option. Stainless steel can also be used as well. It doesn't need plating and it forms its own passive corrosion resistant covering if it is slightly damaged. This passive corrosive resistant covering is why stainless steel is often used in medical and clean room situations. However, stainless steel is difficult and slow to machine.

The third question asks which considerations, if any, are made when designing a mouthpiece for a B-flat versus a C trumpet. Curry has found that most serious orchestral players will use a slightly larger throat and backbore on the C trumpet. Other than that, nothing is substantially different. Curry avers that if a player does not put enough air into a C trumpet, it can sound like a toy. The larger throat helps the player get more air into the instrument and open up the sound.

Next, we talked about the considerations made for the orchestral trumpet player versus the commercial trumpet player. Orchestral players are looking for a large, vibrant, dark trumpet sound whereas commercial players are looking for a more compact, bright sound. Orchestral players usually use a deeper cup and a larger backbore than commercial players. Commercial players generally use a mouthpiece with a smaller throat as well to aid endurance.

To make things easier for a crossover player, the same rim can be used on both the orchestral and commercial mouthpiece. This makes it easier to switch from one to the other. Most orchestral players who also play pops engagements want a mouthpiece they can put in the trumpet and play in the pops situation without having to use something that feels significantly different.

This ties into Curry's reason for designing mouthpieces in the first place. He saw the need to design something that makes playing easier. For the orchestral player, the job is usually only about 10% pops. This type of player does not want to devote an extra hour each day to preparing on a shallow mouthpiece. In Curry's 1.5C-S mouthpiece for orchestral players, the cup of a 1.5C is used, but with the bottom of the cup brought up slightly. This amount is less than the thickness of four sheets of paper. The angle on the bottom leading into the throat is sharper as well. This changes the compression characteristics of the cup. The mouthpiece has the same feel as the orchestral mouthpiece, but the sound is clearer. The backbore is a little tighter which adds brilliance to the sound. These combine to make a mouthpiece that feels comfortable to a primarily orchestral player while allowing him or her to play with a commercial sound.

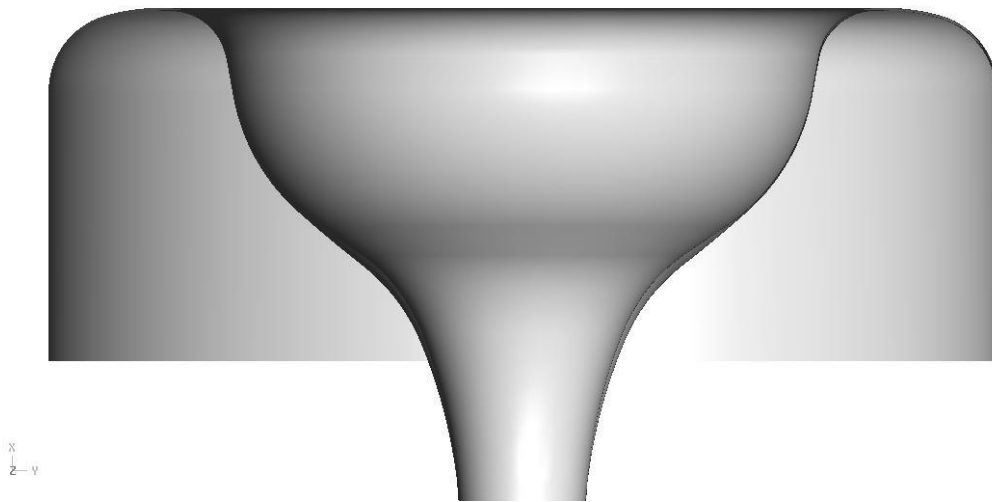

**Figure 14 - Curry 1.5 C and 1.5 C-S Overlay<sup>159</sup>**

---

<sup>159</sup> Image used with Mark Curry's permission

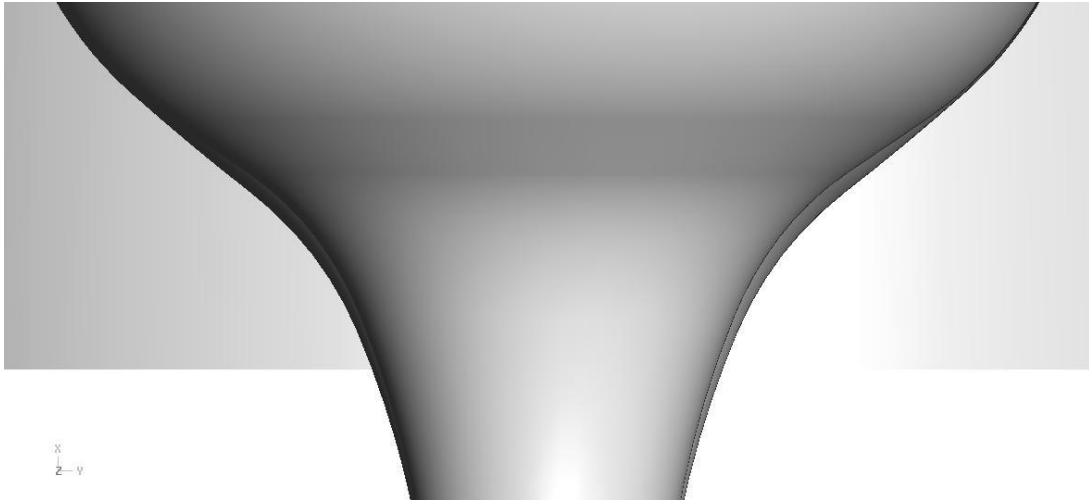

**Figure 15 - Curry 1.5 C and 1.5 C-S Overlay Zoomed<sup>160</sup>**

The comfort of the player is very important because it is what allows the trumpeter to play pops engagements with confidence. The last thing a trumpeter wants when going to a big band or pops engagement is to play so dark that he or she cannot be heard. The 1.5C-S mouthpiece gives the player confidence that their sound will be heard and match with a big band or pops section while allowing them to play on equipment that feels familiar.

The sixth question asks if modern innovations in trumpet design impact trumpet mouthpiece design, and if so, in what way. For the most part, Curry does not take trumpet design innovations into account when designing his mouthpieces. The trumpet is still roughly the same as it has been in the past:  $\frac{1}{3}$  cylindrical and  $\frac{2}{3}$  conical. The way the tubing is bent and the thickness of the material can vary. The mouthpiece can be too light to make the trumpet properly resonate. It can also be too heavy for certain trumpets. Certain lengths of mouthpiece work better with certain trumpets. Designing mouthpieces for specific trumpets is not something that the majority of mouthpiece

---

<sup>160</sup> Image used with Mark Curry's permission

manufacturers do, unless it is a custom design for a specific player and instrument. When working with professional trumpet players, Curry noticed that no matter what equipment they tried, they still sounded like themselves, no matter which mouthpiece variable was changed. It truly can take up to sixty days or longer to adapt to any mouthpiece parameter change.

The last item on the questionnaire asks for a statement about how Curry's mouthpiece designs improve upon the traditional mouthpiece produced by previous manufacturers. Curry's goal when he began making mouthpieces was to make it easier for trumpeters to play while having a source for highly consistent mouthpieces.

Before the advent of the most current state of the art machinery, mass produced mouthpieces had a tremendous amount of variation. Even with new machinery, today's mass produced mouthpieces still possess inconsistencies. Though mass produced mouthpieces today use CNC equipment, much of the precision is lost in the finishing and polishing process. Curry is able to create very high quality mouthpieces that have a low surface finish and require only minimal finishing.

In parting, Curry also wanted to add that technology can both hinder and help the modern trumpet player. Resources for listening to music or learning information about music are readily available on the internet, more so than ever before. The negative aspect of today's technology is that it is too omnipresent. It makes it difficult for people to focus on what they are doing. A vibrating phone in a rehearsal diverts attention away from the task at hand. Multitasking has become something that everybody does, but a point should be made to also take time to focus on one task in a quiet space without distractions.

## **Pickett Mouthpieces**

### *Overview of Company*

Peter Pickett has earned degrees both in trumpet and in mechanical engineering. He earned a Bachelor's of Science in Mechanical Engineering at Virginia Polytechnic Institute and State University in 1995. Pickett worked as an intern at the Crutchfield Corporation in Charlottesville, Virginia for three years during his undergraduate studies. He completed his Bachelor of Arts in Trumpet Performance at Virginia Tech the following year.

Pickett continued his studies at Virginia Tech, earning his Mechanical Engineering Master's in 1998. Pickett focused on the acoustic modeling of the trumpet shape and other aspects of trumpet acoustics in conjunction with active noise control technology.

In 1999, Pickett purchased a lathe and began experimenting with handmade valve caps. This experimentation eventually evolved into trim kits which included bottom and top caps, stems, and buttons manufactured using various CNC machines. Trumpet mouthpieces were added in 2007, developed by combining Pickett's experience as a trumpet player and engineer with professional trumpet players in order to produce one-of-a-kind mouthpieces of top quality.

### *Interview*

The interview with Peter Pickett was conducted on April 4, 2014 via telephone at 7:00am CST. The interview was based on a list of questions provided in an email prior to the interview (Appendix A).

The first question addressed the function of each of the parts of the mouthpiece. We began by talking about the rim. Pickett Brass uses a rim that is designed to be comfortable. The rim is designed a little wider and flatter than common rims to facilitate comfort, but not to such an extent that it restricts the player's embouchure. The mouthpiece must be in balance. If the rim is too wide, it decreases flexibility and if too narrow, tends to be uncomfortable for most trumpeters. The bite on Pickett mouthpieces is considered sharp. This may marginally take away from the comfort for some, but it facilitates quick, superior articulation.

The mouthpiece cup is where most of the tweaking of sound color occurs. The cup can take on numerous shapes from large bowls to very shallow cups. Pickett mouthpieces have fairly traditional cups, but many options are available depending on the player's preferred sound and response.

The alpha angle for Pickett mouthpieces is consistent with the exception of extremely shallow cups. This helps people adapt quickly to a change in mouthpiece through the product line. Deep symphonic cups have the same alpha angle as commercial cups. This allows the mouthpiece to feel similar on the face which is particularly helpful for crossover players.

The throat and backbore go together functionally. Most Pickett mouthpieces have a #27 throat because it matches well with a majority of trumpet players. Throat size can be changed depending on how much air you put through the trumpet and what kind of trumpet you play. Very tight trumpets do not need a lot of resistance in the mouthpiece and may need a more open throat, whereas an open trumpet may work better with more resistance in the mouthpiece provided by a smaller throat.



The throat also can contribute to a big difference in the sound. A longer, tighter throat will be a little bit brighter and will slot tighter than a mouthpiece with a shorter throat. This depends on the trumpet and the player because the trumpet, mouthpiece, and player work together as a complete system. Changing one aspect of the mouthpiece does not necessarily produce the same result every time depending on the trumpet and the player.

The backbore, like the cup, comes in many different shapes which can change the color of the sound, intonation, and blow resistance. Large symphonic backbores have less resistance and produce a bigger sound. Tight commercial backbores that do not flare out very quickly, have very tight slots, and produce a more brilliant sound. They can have a tendency to play sharp in the upper register, which can be balanced by changing other aspects of the mouthpiece. The cup, throat, and backbore all work together to give the mouthpiece the sound and resistance the player desires. These three elements in conjunction with one another also have a huge effect on intonation.

The external shank taper is the same as almost every other trumpet mouthpieces in the world, a Morse #1 taper (.04988 inch diameter taper per inch in length). The interface with the trumpet is fairly consistent so this taper works with all standard trumpets. The resulting gap, however, is not consistent and this will be addressed more fully during the second question. The gap is determined by how far the mouthpiece goes into the receiver and the resulting distance between the end of the mouthpiece and the end of the leadpipe. This gap distance is critical. Most people do not take the time to adjust the exterior shank taper in order to get the ideal gap.

The external diameter at the end of the Pickett mouthpiece is 0.385 inches, with a Morse taper from there. This number was chosen because it works well for most trumpeters. However, that is not a guarantee that it will work for all players because instrument receivers are not consistent. Because of this, there are many systems on the market today to accommodate players' equipment. Pickett suggests Reeves sleeves which is a very simple and consistent system for adjusting outside shank diameter and resulting gap.

The overall length of the mouthpiece is consistent among the standard line of Pickett trumpet mouthpieces. The important factor is the internal air volume of the mouthpiece. A very long mouthpiece with a small cup and a tight backbore can play fine. An extremely short mouthpiece with a large internal volume can also play well. Because of this, it is not necessarily the overall length that is important, but the balance between length and the overall internal volume. As a result, there are some mouthpiece combinations that simply do not work, but there are numerous combinations that do work. The length can vary with custom designs.

The second question discussed the importance and function of the venturi, the gap, mouthpiece material, and plating. We defined the venturi to mean the exit internal diameter of the mouthpiece. The venturi is an incredibly sensitive portion of the mouthpiece. When doing custom work with an artist, and he or she suggests that a mouthpiece feels a little stuffy, before making larger changes in the backbore, cup, and throat, opening up the last quarter inch of the venturi by a few thousandths of an inch makes the mouthpiece play completely differently. It becomes much more free-blowing and open. Some people believe that the mouthpiece exit venturi should match the

entrance venturi of the leadpipe. This is just one philosophy, but Pickett Brass does not necessarily subscribe to it. The correct venturi comes back to finding the correct balance between the mouthpiece, the player, and the trumpet.

The gap is one of the most underappreciated aspects of the mouthpiece and trumpet that can make a large difference. Many older trumpets have receivers that have been worn from regular use and, as a result, can have almost no gap at all. A trumpet with no gap can play just fine, but may not slot as well and can lack brilliance. Opening up the gap to its ideal spot for the player, trumpet, and mouthpiece combination makes the notes slot very well, the intonation will be improved, and the sound and response will be better all-around. A gap that is too big can cause the trumpet to feel stuffy and can reduce response. The gap can make a profound difference.

A person can experiment on his or her own doing simple things - like taking a piece of tape or paper and wrapping it around the mouthpiece shank at different thicknesses. This does not cost anything and can give the person a rough idea of what can change via gap adjustments.

There are many ways to measure the gap. As for the 'ideal' gap, some players believe in 1/8 inch or 1/16 inch gaps, but it really is an individual matter based on the player, mouthpiece, and trumpet combination. Pickett mouthpieces are often manufactured to fit Reeves sleeves which provide a quick and easy way to adjust the gap.

Most Pickett mouthpieces are made from various brass alloys. These materials work well for mouthpieces, machine efficiently and accurately, and make for excellent

finishes. It is a good all-around material from a manufacturing perspective. Cast Delrin, Acrylic, and Ebonite (hard rubber) mouthpieces are manufactured as well.

The material has a number of different effects. If a mouthpiece is made out of different materials, it will play and respond differently. The main reason why players choose a polymer mouthpiece is because they play it outside and do not want it to be cold on their lips. The mouthpiece sounds different because the material has a different structural/acoustic damping response. It also feels different on the embouchure because skin tends to interact with it differently than with gold plated brass, which tends to feel slippery. The higher copper content tops and mouthpieces tend to sound brighter. Many lead players like to use the high copper mouthpiece tops for that reason. Playing lead is not as much about playing loud as it is about having a sound that cuts through so that the player does not have to work as hard. The denser copper materials help produce that brighter sound.

Plating of the mouthpiece is more of a personal preference. People who are allergic to silver will tend to go with the gold plating. People who are allergic to nickel tend to have reactions to various platings because nickel can be an additive in alloys. Those players often go with Acrylic or Delrin. Pickett also offers a zirconium based plating which does not contain any nickel which gives players a hypoallergenic metal mouthpiece option. Some people will have an allergic reaction to the copper so those mouthpieces are plated as well. A raw brass mouthpiece must be plated because there is lead in typical alloys. For adults, that may not be a huge issue, but for children, having lead ingested in their system is detrimental for neurological development. The plating protects people from the toxic aspects of that material.

The next question asks whether or not there are design differences when making a mouthpiece for a B-flat versus a C trumpets. Pickett Brass does not design mouthpieces specifically for B-flat or specifically for C trumpet. There are many mouthpiece styles to try, but they are not designated as for B-flat or C trumpets. When it comes to choosing a mouthpiece, it is about the instrument, mouthpiece, and player system as a whole. A mouthpiece does not necessarily have to be shorter in order to be ideal for a C trumpet. It is all about the internal volume, as was discussed in the question about the overall mouthpiece length. A number of short backbore shanks have been made for people who like the cup that they have but need a shorter mouthpiece because of their trumpet and the need to balance the trumpet/mouthpiece/player system.

The choice of mouthpiece, regardless of whether for B-flat or C, becomes a matter of personal preference based on how a person plays, personal habits, individual tendencies, and desired feel. Some of the first mouthpiece designs by Pickett Brass came from working with Vince DiMartino<sup>161</sup> on a number of his mouthpieces across all types of trumpets, and from that work, came Pickett's design. Those designs worked well for a single player and from there, after working with other players, the line has grown. This continues to prove that everybody is different and what works for one person may not work for another.

The next question discusses what considerations are made for designing mouthpieces for commercial versus orchestral trumpet players. The biggest difference

---

<sup>161</sup> Vince DiMartino is a well-known jazz and classical artist. He has performed as the lead and solo trumpet with the Clark Terry Band, the Chuck Mangione Band, the Lionel Hampton Band, and regularly performs as a guest artist with other college and professional jazz bands. He also has been a soloist with symphony orchestras including Cincinnati, Buffalo, North Carolina, and others. He has been featured on many of the Cincinnati Pops Orchestra's recordings as well. DiMartino is the professor of trumpet at Centre College.

between an orchestral mouthpiece and a commercial mouthpiece is that the commercial mouthpiece tends to be shallower. Commercial and orchestral trumpet playing are two very different concepts which utilize two very different sounds and approaches.

Orchestral trumpet playing is about getting a big, full sound. It needs to be able to be full and have a lot of volume, characterized as big and fat, with the ability to carry. It is one of the most demanding styles of trumpet playing. The mouthpieces tend to have a large interior volume in order to allow the players to get a lot of air through them. They typically have large bowl-shaped cups, larger throats, and larger backbores. This allows a great deal of air and a great deal of energy to move through the mouthpiece and into the trumpet.

On the opposite end of the spectrum is the commercial trumpet player. The job of the commercial trumpet player is to produce a particular sound that will carry with as little work as possible. Commercial players need a very bright, cutting sound that is able to carry over a big band without having to work too hard. To achieve the commercial sound, the mouthpiece rims tend to be smaller, the backbores tend to be tighter, and the cups tend to be shallower.

The fifth question addresses the crossover trumpet player who has to play both commercial and orchestral trumpet. The crossover artist is most likely for whom Pickett Brass does the majority of work, because there are few people in this business who play only orchestral or only commercial music. Anybody who wants to work regularly has to be able to do everything.

Vince DiMartino is an excellent example of this. He plays a great deal of commercial literature, but also plays solo literature in recitals and performs in chamber

groups and with orchestras. He plays very middle-of-the-road equipment. This helps him cover all the bases as efficiently as possible. He does use a different mouthpiece for doing jazz engagements than when he is playing chamber music in a quintet. There is no hard and set rule that says you have to play the same mouthpiece for everything. A person who does this is most likely working too hard. It is important to have the right tool for the job and the jobs of orchestral and commercial players tend to be totally different. There are a lot of compromises in design through which you can attain the best of both worlds and get your job done as required.

The next question addresses whether innovations in trumpet design impact mouthpiece design and if so, in what way. There have in fact been subtle changes in trumpet design over the last century, but essentially, the trumpet design itself has not changed significantly. Most of the changes have been in the manufacturing approaches to the instrument. Fundamentally, the trumpet design has been fairly stable.

People are looking for more answers now than they ever have before. In the early part of the twentieth century, you got your cornet or trumpet and just played it with whatever mouthpiece it came with. Now, there are many more options out there than ever. Almost every design can work for somebody. The interesting part of the recent history is that there have been more people who have come up with new concepts than ever before. For example, Roger Ingram<sup>162</sup> plays equipment that is extremely small and shallow which he may not have been able to get in the early part of the twentieth

---

<sup>162</sup> Roger Ingram is a lead trumpet player who has performed in the Woody Herman Orchestra and with Harry Connick, Jr., Ray Charles, Paul Anka, and his own big band which he co-led with Steve Elliott. Ingram has also played in over 20 Broadway shows. He is currently an Artist-in-Residence at Roosevelt University in Chicago.

century because people just did not make it. The difference between the past and now, both in trumpet and mouthpiece design, is that there are vastly more options.

The last question asks how Pickett's design concepts improve upon traditional mouthpieces. When Pickett first started making mouthpieces, a very traditional interior and exterior shape was chosen, resulting in a solid, traditional product. Ultimately, the outside shape was changed, along with the backbores, throats, and cups. The quality that Pickett really brings to the table is consistency. Having an exceptional mouthpiece design is one thing, but being able to manufacture what you intent to, repeatability is a quality that is of utmost importance.

Peter Pickett is a mechanical engineer who also has formal training and experience in trumpet performance. All Pickett products are manufactured in house; nothing is outsourced except the final plating. All manufacturing processes are controlled, measured, and consistency maintained. All of the carbide tooling is hand-picked, extremely robust, reliable, and controllable such that when mouthpieces are produced, consistency is assured. Even though Pickett may manufacture what some consider to be a traditional mouthpiece, players know that it is made well. Trumpeters do know that mouthpieces are made in a way that is consistent, hand finished, and that care was taken. When people visit the shop, they can see firsthand the quality, processes, and care taken to make the personalized mouthpieces.

## **Warburton Mouthpieces**

### *Overview of Company*

Warburton Music Products was founded by Terry Warburton in 1974.

Warburton started playing trumpet when he was 14 years old. He began working at a



musical instrument store in Toronto, Canada soon after. Warburton had access to all the different mouthpieces the store sold and became fascinated by them. He met many of the manufacturers, including Robert Giardinelli, because he was selling their mouthpieces.

When Warburton started his own mouthpiece manufacturing company, he used the knowledge of what was currently in the marketplace, what people did not like about some of the available mouthpieces, and what he personally did like about some of the mouthpieces in the marketplace, as an influence to his designs.

Warburton's company started in Canada. After five years, Giardinelli hired Warburton to go to New York and run his operation. Warburton returned to Canada after realizing that he did not want to live in New York City for the rest of his life, then moved to Florida in 1980, where the shop is currently located.

In 1986, Warburton was the first American company to use CNC machines to make mouthpieces. Warburton continues to add new innovative products to help trumpet players, such as an embouchure trainer called the P.E.T.E. He is also known as for his two-part mouthpieces with interchangeable cups and backbores. A new plastic trumpet called the Tiger Trumpet has recently been introduced, as well as a new line of wooden straight mutes and cup mutes.

#### *Interview*

The interview with Terry Warburton was conducted on April 11, 2014 via telephone at 10:20am CST. The interview was based on a list of questions provided in an email prior to the interview (Appendix A).

The first question on the list asks Warburton to dissect the mouthpiece into its constituent parts and describing the function of each. We began with the rim. The rim has a major effect on the comfort of the player. The inside diameter of the rim is one of the most important parts of the mouthpiece. The ideal inside may diameter change based on what type of music the trumpeter is playing, and may be different from player to player. Larger inner diameters are well suited for orchestral playing, whereas smaller inner diameters are commonly used on commercial mouthpieces.

The inside contour of the rim affects intonation, attack, and comfort. A rounded inside contour can make a mouthpiece more comfortable, but the attacks can lack clarity. A flat rim can impede flexibility. A wide rim is more comfortable than a narrow rim, but also has a negative effect on flexibility. The ideal rim shape varies from one individual to another.

The design of the cup is more complicated than that of the rim. The shape of the cup and the depth of the cup are both very important in terms of tone quality. Both are very specific to the desired sound, and to the type of music the trumpeter is playing. A deeper cup produces a bigger sound, but makes it more difficult to play in the upper register. A shallow cup can make it easier to play in the upper register, but the tone quality suffers.

The cup shapes used in Warburton's designs are based on Warburton's experience as a trumpet player. He experimented with different shapes and learned which parameters affect certain aspects of the sound. He created a large number of cup options that provide the entire gamut of trumpet players, from lead to orchestral, with a mouthpiece that can produce their desired sound. If a person desires a specific

alteration on a cup design, whether it is depth or shape, that type of custom work can be done as well.

The alpha angle plays no role in Warburton's design. There is no mouthpiece that actually has an angle in the place that Radtke designates as the alpha angle. Mouthpieces are designed with arcs and curves. Warburton believes that the terminology is misleading.

The throat and backbore of the mouthpiece do essentially the same thing, but in inverse proportion. Opening up the throat can give the player a bigger sound and can make the mouthpiece more free blowing. This also requires more air to play. If a substantially bigger sound is desired without having to use significantly larger quantities of air, opening the backbore is a better option.

Orchestral trumpet players usually use a larger bore (throat) than other trumpet players. The mouthpiece of most orchestral players is between a #22 and #24 bore, whereas most other trumpet players use a #27 bore. There are trumpeters who play bores that are larger than this and trumpeters who play bores that are smaller than this. In addition to larger bore sizes, the orchestral player most often uses a larger backbore than a commercial player. Mouthpiece selection is an individual matter. Terry's favorite saying is "If it sounds good and feels good, then it is good!"

Warburton's mouthpiece line includes several options in shank taper. The flugelhorn line includes six different shank tapers. These mouthpieces have the same rate of taper (Morse #1), but different diameters and different thicknesses. The purpose of these different tapers is discussed in the second question regarding the venturi and the gap.

The overall length of Warburton's line of standard trumpet mouthpieces is uniform. There are mouthpieces on the market of different lengths which serve specific purposes. For example, British cornet mouthpieces have a shorter backbore than American cornet mouthpieces because they have deeper cups. If the deep cup of a British cornet mouthpiece was used with a standard cornet backbore, it would play extremely flat.

The next question addresses the importance and function of the venturi, gap, material from which the mouthpiece is made, and plating. Each of Warburton's backbore styles has a different length venturi. The venturi on the star backbores are all about 10/1000 of an inch and start tapering immediately. That style of venturi allows the mouthpiece to be freer blowing and increases flexibility. However, it makes it harder to accurately slot some of the upper register notes. If the length of the venturi is too small or too large, the mouthpiece will not play well.

The same is true of the gap. Nobody understands exactly how the gap works, but we do know that it does affect trumpeters substantially. Bob Reeves said, "Too much gap is bad, and no gap is worse." Warburton agrees with this statement. In forty years of making mouthpieces, Warburton has worked with two trumpet players who played best with no gap. For everybody else, trying to play with no gap was a disaster. Too large of a gap can also be a disaster. A gap of about .100 inches to .110 inches works for most players on most trumpets. If the gap is too big, the trumpet feels very stuffy and the player may experience problems with attacks. If it is too small, it becomes very difficult to control the pitch.

Trumpet players have many choices when it comes to material. Most Warburton mouthpieces are made of standard brass. Mouthpiece tops are available which are made out of Delrin. Delrin is a soft polymer. The human body generally has no reaction to Delrin, which makes it a very hypoallergenic choice. Delrin mouthpieces tend to lack a little of the sparkle that is achieved when using a brass mouthpiece. Some players like this because it has the effect of immediately darkening the sound. They are quite popular in England. The cornet soloist for the 2011 Royal Wedding in England performed on a Warburton Delrin mouthpiece. Warburton also makes mouthpiece tops out of clear Lexan. Lexan's surface characteristics provide players with more grip than Delrin.

The newest material used by Warburton is a hard rubber called Warbonite. This has become extremely popular. Jeff Curnow of the Philadelphia Orchestra plays a Warbonite cup because he is allergic to metal mouthpieces. The Warbonite mouthpieces are the closest any non-metal mouthpiece has come to sounding like a brass mouthpiece.

Brass mouthpieces must be plated because the material contains skin irritants. Silver plating is a popular choice. Warburton does not personally like gold plating because it is too smooth and slippery, though players who play with a wet embouchure tend to like it. Warburton uses steel wool to create a rougher surface on gold plated mouthpieces used by players who play with a dry embouchure but need to use a gold plated mouthpiece because of allergies.

The third question asks what considerations are made when designing a mouthpiece for a B-flat versus a C trumpet. Warburton does not design mouthpieces to

be used specifically with B-flat or C trumpets. The mouthpiece that works best is a function of the person playing the instrument. Any of Warburton's mouthpieces can be used on either B-flat or C trumpet. Some may work better on one trumpet than the other for an individual player, but the matter is more subjective than objective.

The next question discusses the considerations made when designing mouthpieces for the orchestral trumpet player versus the commercial trumpet player. The orchestral player usually uses a mouthpiece with a larger rim diameter and a deeper cup. The rim itself is slightly thinner than what is used by commercial players. Commercial players usually use moderately shallow mouthpieces with a wider, more comfortable, rim because they tend to press the mouthpiece to the lips harder than orchestral players. This generalization is not true of all trumpet players.

This leads into the next question which asks what considerations are made when designing a mouthpiece for the crossover trumpeter. Using the same mouthpiece for both commercial and orchestral music is a bad idea and forces the player to make compromises in both areas. This requires the player to work harder in order to create his or her desired sound and, as a result, endurance is decreased. A crossover player tends to like to use the same rim for both genres. Using a different cup shape with the same rim can help the crossover player adjust more easily when switching genre. This is easy to do with Warburton equipment.

The sixth question asks if modern innovations in trumpet design have impacted mouthpiece design and, if so, in what way. Most of the innovations Warburton has seen in trumpet design make the trumpet play worse. An example is heavyweight trumpets with a great deal of extra metal. Warburton essentially ignores the trumpet

manufacturers. He has developed a prototype trumpet which will be available for people to try at the 2014 International Trumpet Guild Conference. A trumpet and a mouthpiece are two separate components. You do not design one to make the other.

The next item on the questionnaire addresses how Warburton's design concepts improve upon traditional trumpet mouthpiece design. Warburton's initial goal was to provide a comfortable mouthpiece that is playable by the average trumpet player. A custom mouthpiece can be made any way that a trumpeter wants and many unusual designs have been made. These tend to work for the individual player, but not the majority of players.

The mouthpieces that Vincent Bach designed in the 1920s were created at a time when high C (C6) was considered the top of the range. Warburton mouthpieces are designed to play well above that point.

The original Mount Vernon Bach 7C mouthpieces (the recommended student model at the time) had a smaller inside diameter than current 7C mouthpieces, had a more comfortable rim than current 7C mouthpieces, and functioned well as a student model. They most likely devolved into what they are today because of the need to mass produce these mouthpieces. The original outside diameter was once 1.055 inches, but is now 1.080 inches, which is a huge difference in terms of how much rim is contacting the lips. This affects the comfort of the mouthpiece.

The rims of the traditional Bach mouthpieces are not as user friendly as trumpeters would like them to be. Warburton rims are subtly different, but in a business where a ten thousandth of an inch change can be perceived, these subtle changes have a real impact. There are players who find the "2 rim" to be too large but the "3 rim" to be

too small. The difference in these rims is 10/1000 of an inch, which is approximately the thickness of three human hairs. For these players, a half size mouthpiece can be made and this can give them the comfort in the mouthpiece needed in order to play at their best.

## **Wedge Mouthpieces**

### *Overview of Company*

The Wedge mouthpiece was created by Dr. Dave Harrison. Dr. Harrison has practiced medicine since 1983. He specializes in emergency medicine, is the Medical Director of the VGH Hyperbaric Unit, and researches Hyperbaric and diving medicine. He is also the principal trumpet of the Richmond Orchestra in Richmond, British Columbia, and performs regularly at Kitsilano Community Church. Dr. Harrison began experimenting with mouthpiece design in 2007, applying his knowledge of physiology, anatomy, and the blood supply to the face to mouthpiece design.

### *Interview*

The interview with Dr. Harrison was conducted on April 3, 2014 via telephone at 3:00pm CST. The interview was based on a list of questions provided to Dr. Harrison in an email prior to the interview (Appendix A).

The first question discusses dissecting the mouthpiece into its constituent parts and describing the function of each of those parts. Dr. Harrison began by discussing the fact that the functions of many of the parts are interrelated, especially in regard to the rim and the cup.

The original Wedge rim design was derived from Dr. Harrison's theories about how the embouchure works, and the effects of dental structure on one's ability to play.



He specifically referenced Mark Van Cleave's<sup>163</sup> research on dental structure and trumpet playing, which suggests that a wedge shape formed by the central incisors can be an asset for some players. Another inspiration for this mouthpiece design was John Lynch's Asymmetric mouthpiece. Dr. Harrison liked the benefits to the upper register achieved with this mouthpiece, but experienced problems with the low register and limited flexibility due to the flat rim which is concomitant with its asymmetric design.

The first experimental Wedge mouthpieces were modified Asymmetric mouthpieces with a more rounded rim. Dr. Harrison's intent was to collaborate with Lynch to produce a hybrid of their ideas. Lynch declined. Dr. Harrison therefore continued to experiment with Wedge rims, but he could not use the design concepts from Asymmetric because they are patented.

After experimentation with the rounder rim, Dr. Harrison began experimenting with the other dimensions of the mouthpiece. He arrived at a curvature of the mouthpiece, which is designed to provide the benefits of the wedge dental formation described in Van Cleave's research, without requiring dental modification. This shape can be seen in the figure below.

---

<sup>163</sup> Mark Van Cleave has performed with several big bands, including the Smithsonian Jazz Masterworks Orchestra and the Guy Lombardo Orchestra. He played for Maynard Ferguson's 75<sup>th</sup> birthday bash in 2003, and formed the Mark Van Cleave Jazz Orchestra in 2006 to raise money for a scholarship in memory of Ferguson. He formed the Velocity Big Be-Bop Band in 2011. Van Cleave's book, *Maximizing Practice vol. 2: Developing Trumpet Range, Power, and Endurance*, further explains his research regarding how dental formation affects trumpet performance.

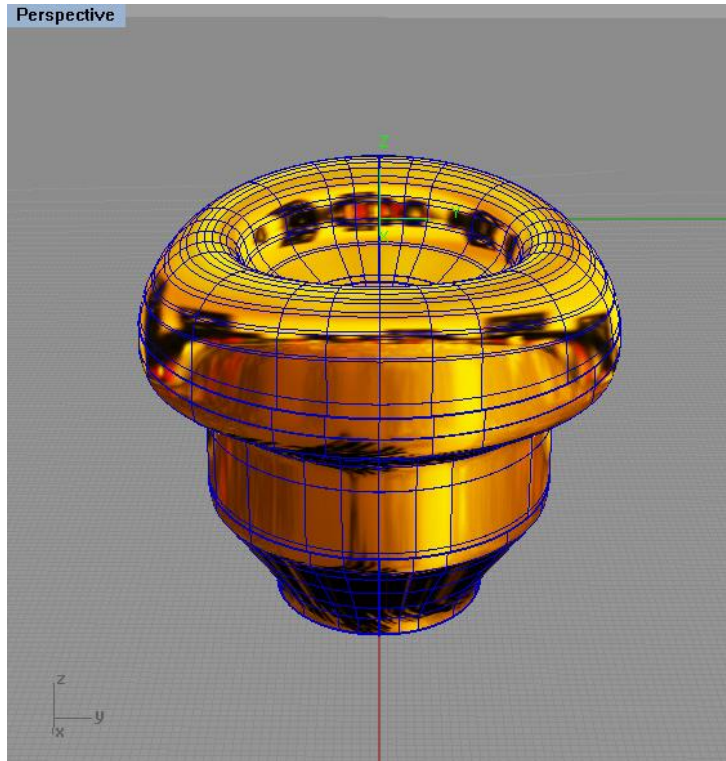

**Figure 16 - Wedge Mouthpiece<sup>164</sup>**

When properly orientated, this new rim design has shoulders which slope away from the embouchure. The high points of the lateral rim contour are moved sharply toward the inside. The rim and cup of the mouthpiece form an oval shape which is narrower on the horizontal axis than on the vertical axis. Oval mouthpieces of the past were placed with the long dimension of the oval horizontal in order to establish maximum contact with the lips, which was assumed to provide players with better comfort. This idea was patented by Z. Albert Meredith of Marion, Ohio in 1908, but had been experimented with by other manufacturers as well.<sup>165</sup> The Wedge mouthpiece is the opposite in concept.

---

<sup>164</sup> Image used with Dave Harrison's permission

<sup>165</sup> Olson, March 2010, 59

This mouthpiece is designed to decrease contact in certain areas. The mouthpiece incorporates a lateral dip, which is a saddle-shaped curve in the cup, placed with the high points at the top and bottom of the vertical axis and the low points on the horizontal axis. This design relieves the pressure from where the rim presses the lips against the teeth laterally.

The combination of these design concepts transfers pressure mostly to the top and bottom of the mouthpiece (12 o'clock and 6 o'clock if it were a clock face) instead of having the pressure distributed evenly around the mouthpiece. This means that there is less pressure at the where the rim presses against the teeth laterally. This theoretically improves endurance and flexibility because circulation is not impaired by the mouthpiece pressure from the horizontal axis of the mouthpiece.

In the lips, arteries radiate from the sides toward the center. The lymphatic and venous drainage goes in the opposite direction. When metal presses the lips against the teeth, especially in the early 20th century horizontal oval mouthpieces described above, the circulation of the lips is hindered. Essentially, the oxygenated blood is not able to get into the embouchure and the drainage is not able to get out. This causes swelling and will reduce endurance. With the Wedge design, the lateral sides of the embouchure are free to move which improves flexibility and prevents the circulation problems described above.

The rim width of the Wedge mouthpiece is marginally wider at 12 o'clock and 6 o'clock than its standard mouthpiece counterpart. It is narrower at 3 o'clock and 9 o'clock. This allows the pressure that was taken off the sides to be redistributed to a

wider top to bottom surface area. It is designed to feel the same width as the standard mouthpiece.

Another area which affects the feel of the mouthpiece in relation to its standard mouthpiece counterpart is the bite radius. The bite radius is inner rim diameter which contacts the lip. A large bite radius creates a softer bite which adds comfort. The bite radius of Wedge mouthpiece is similar to that of its standard counterpart, although the inner edge is sometimes softened. The playing characteristics of the Wedge mouthpiece are also designed to be similar to the standard mouthpiece from which it is based, but with the advantages described above.

Because the lips are not pressed against the teeth at the sides, trumpeters are able to play mouthpieces with smaller rim diameters without the detrimental effects on flexibility, endurance, and circulation often experienced with small rim diameters. Also, trumpeters can play mouthpieces with a smaller cup volume without having the lower register suffer in the way that it does with many lead mouthpieces.

The shape of the cup is oval all the way down to the throat. The vertical axis, being longer, gives the mouthpiece a dark sound, characteristic of a larger mouthpiece, while the shorter horizontal axis gives it the efficiency advantages of a smaller mouthpiece. For most players, this increases the richness and fullness of the sound throughout the register and increases the range that can be played using this full sound by as much as a major third. If an increase in the quality of the lower range occurs, but an increase in high range was desired, the player can move to a shallower cup with a smaller diameter. This change will effectively move the optimum range with excellent tone upward. For the average player, the standard Wedge design increases both the

quality of the lower range and the usable upper range while providing a more even response in all registers.

Wedge mouthpieces typically have a lower alpha angle than their standard mouthpiece counterpart. A high alpha angle provides better support for the lips, but can stop the vibration if the lips contact the cup, cause a double-buzz, and other problems. Different players can tolerate different alpha angles depending on how far their lips protrude into the mouthpiece. Players with a lot of lip intrusion cannot play with a high alpha angle. Wedge mouthpieces are generally designed with a lower alpha angle than a comparable standard mouthpiece because the lateral dip allows for slightly more lip intrusion.

The standard throat for a Wedge mouthpiece is #27, although #25 is also offered. Because the double-oval shape produced by the cup and rim produces some resistance on its own, many players like a larger throat to compensate for this. The most important determinant for blow resistance is the throat size, although the backbore also affects this. A larger backbore provides less blow resistance and a darker sound while a smaller backbore produces a more compact sound with more bright overtones. All of this is subject to human perception.

An open throat also makes the slots wider. Because of this, a player who is not using his or her air support and uses tension in the upper register tends to go sharp. Instead of thinking that an open throat makes pitches go sharp, it is more accurate to say that an open throat allows more room for players to go sharp depending on how they are playing the instrument.

A two-part Wedge mouthpiece is available in which the top screws out of the backbore similar to the way it does with mouthpieces made by Pickett Brass and Warburton. The place where the parts of the mouthpiece join can cause turbulence if the match is not perfect. All joints in Wedge mouthpieces are made with a one or two thousandths of an inch step up in diameter in the downstream part in order to avoid playing against a lip caused by the slight play present in modular mouthpiece threads.

The backbores are all made in two parts which allows the player several options for adjusting the gap. See the figure below.



**Figure 17 - Wedge Two-Part Backbore<sup>166</sup>**

The shank taper on Wedge mouthpieces is the same as other mouthpieces. This Morse #1 taper is an industry standard. However, the overall length is variable. Dr. Harrison agrees with David Monette's arguments for shorter mouthpiece lengths to be used with modern trumpets. The standard length is too long which causes some partials

---

<sup>166</sup> Image used with Dave Harrison's permission

to be flat. This is why, especially on C trumpet, E5 is very flat. A shorter mouthpiece can fix this problem. Wedge offers a full length mouthpiece that works well in many older B-flat trumpets, such as a 1920s Conn. Most modern trumpets work better with the shorter Wedge mouthpiece. This does tend to make G5 sharp. The two-part backbore allows a player to select a shorter shank, adjusting it to about the length of a Monette B-flat or C mouthpiece. One-piece mouthpieces in this shorter size are also available.

During the second question, we clarified the definition of throat because Dr. Harrison asserts that throat and venturi can mean the same thing. The venturi is sometimes thought of as the second cup where the cup transitions into the narrowest part of the mouthpiece. Others call that area of the mouthpiece the shoulder. The Wedge mouthpiece uses a softer shoulder to restore some of the darker sound because the cup volume is usually less than its standard mouthpiece counterpart. Also, a longer throat is said to flatten highs and raise the lows whereas a short throat spreads the highs and lows. This is not unique to the Wedge mouthpiece but is disputed: some manufactures believe the effect is the opposite.

The gap is also an aspect in which there is tremendous variability in opinion. People generally agree that a short gap decreases slotting distance and increases flexibility, and that a large gap has the opposite effect. People disagree about whether the gap increases or decreases slotting in the lower register, as well as the effect on articulation and responsiveness.

The reason for many of the disagreements regarding the gap is that different companies have different ways of adjusting the gap. For example, Reeves sleeves

change not only the gap, but also the exit thickness of the mouthpiece. That also has an effect on how the mouthpiece plays. Wedge uses a system in which decreasing the gap also decreases the exit diameter of the mouthpiece, but not the exit thickness which produces a different effect. This is done by providing mouthpiece lengths which can be interchanged at 1/16 inch increments. There is no industry standard for gap due to variability in trumpet receivers and mouthpieces. Most players have no idea what size gap they are playing with and many cannot tell the difference.

Next, we addressed the available material options from which a mouthpiece is made. Early Wedge mouthpieces were exclusively comprised of plated brass until Trent Austin<sup>167</sup> requested a stainless steel mouthpiece because of metal allergies. When this was done, it was found that the stainless steel produces a brighter sound, allows for extremely fast response, and is very responsive when the player is articulating softly. It also projects very well, but can be unstable. This means that the tendency to chip notes becomes worse. It is also very difficult to color the sound with a stainless steel mouthpiece. The two-part mouthpiece system allows a player to put a stainless steel top on a brass backbore. This gives the mouthpieces the responsiveness of stainless steel with the ability to color the sound provided by the heavier brass backbore. The added weight of the brass also cuts down on chips and clams which tend to be more prevalent in the stainless steel mouthpiece.

Wedge mouthpieces are also available in plastic, in one-piece and two-piece varieties. The one-piece plastic mouthpiece has a dark sound and lacks brilliant

---

<sup>167</sup> Trent Austin is a Boston-based jazz and classical trumpet player. He has performed with Arturo Sandoval, Clark Terry, Natalie Cole, and many others. Before moving to Boston, has performed as the featured trumpet soloist with the Artie Shaw Orchestra for eleven years. Austin has recorded four CDs. He performs regularly in the Boston area and also maintains an active teaching studio.



overtones. In order to get resonance with a plastic mouthpiece, a larger throat is needed. Plastic mouthpieces are very responsive when articulating softly, but it is difficult to get a percussive attack on the note. They can get loud, but they do not project well because of the lack of brilliance and core. Plastic also does not slot as securely as a metal mouthpiece.

In terms of feel, plastic has a lot of grip on the embouchure. It is softer and has more give than metal mouthpieces. For this reason, plastic is a great choice for trumpeters with braces. In combination with the Wedge rim and cup, which cups over the braces and takes the pressure of the sides of the embouchure, students are able to perform as if they do not have braces anymore. They immediately sound better and are more comfortable playing. In addition, many people believe that plastic warms up faster, but in reality it is the same temperature as the metal mouthpieces. Plastic feels warmer because it does not conduct heat away from the body as quickly as metal. Clinicians love this because it allows them to talk during their clinic, then pick up the trumpet and play without it feeling cold.

If a plastic top is combined with a brass backbore, about 75% of the core in the sound is restored and the slotting improves drastically. A plastic top combined with a stainless steel backbore makes a very responsive mouthpiece when articulating softly with a very quick response. The combination of the plastic and the stainless steel allow the mouthpiece to project almost as much as brass with the responsiveness qualities of both plastic and stainless steel. Dr. Harrison personally plays on a mouthpiece with a plastic top and stainless steel backbore.

Plating does not affect the acoustic characteristics of the mouthpiece. A stainless steel mouthpiece plated in gold or silver sounds exactly like an un-plated stainless steel mouthpiece. Stainless steel does not need to be plated, but is a chameleon in terms of feel. A brand new un-plated stainless steel mouthpiece will feel very sticky, but when combined with oil (whether purposeful or from the face) it becomes very slippery. Plating the stainless steel will give it a more consistent feel.

Some people say gold plated mouthpieces warm up faster than silver plated mouthpieces, but this is not true. The thermal conductivity of gold plating is no different from silver or other metals. It feels smoother on the face not because it is a softer metal, but because gold gets microscopic scratches in it and those scratches hold water which makes it feel slippery.

The next question regarded the difference between mouthpiece design for B-flat and C trumpet. This was addressed previously during the discussion about mouthpiece length. A C mouthpiece is usually shorter, has a more open throat, and a bigger backbore. The interchangeable shanks allow the player to buy one mouthpiece with two shanks. This way, the player can use the same top part for both the C and B-flat trumpets. Some of the newer Yamaha and Bach C trumpets play in tune with a full length mouthpiece and do not need the shorter shank.

The fourth question addressed the differences in mouthpieces for commercial versus orchestral trumpet players. Usually, orchestral trumpet players use a larger diameter cup. Commercial players generally prefer shallower cups with a smaller diameter. The stainless steel and gold plated stainless steel mouthpiece tops are a good choice for commercial players due to their brilliance and projection. A completely

stainless steel mouthpiece is not usually recommended, but it does provide maximum projection and brilliance, which can be beneficial to certain lead players.

Some commercial players like to play with a very small throat but Wedge does not make anything smaller than a #27 throat. The Wedge cup design does not work as well with a throat tighter than that, though the player can experiment with using other backbores from other manufactures with the two-part mouthpiece system. The intrinsic resistance created by the double oval cup and rim design works best with a #27 or larger backbore for most trumpet players.

Another question discussed compromises made for crossover artists who must play both orchestral and commercial trumpet. Some people believe that it is best to keep the same diameter with a shallower cup, however Dr. Harrison does not subscribe to that belief. It is important to use the right tool for the job. For most players, this means playing a smaller diameter as well as a shallower cup. This makes it much easier to produce the correct commercial sound. If a player requests a mouthpiece with the same diameter but with a shallower cup, it can be made, but the majority of crossover artists do play a smaller mouthpiece when playing commercial music. The primary reason for using the same diameter is psychological. The human body is much more adaptive than people give it credit for. Fear of not being able to play a smaller mouthpiece is a huge factor for why smaller mouthpieces do not work for some people who like to play on the same rim when performing orchestral and commercial music.

The sixth question addressed the effects of modern trumpet design innovations on mouthpiece design. Dr. Harrison stated that the primary innovation with newer instruments is that many of them are better in tune. The discussion about mouthpieces

for B-flat versus C trumpet addresses this to some extent. If a new C trumpet slots well using a traditional length mouthpiece and E5 is in tune, a shorter mouthpiece is not needed. Some newer trumpets have very mouthpiece deep receivers, and others, such as Taylor Trumpets, offer proprietary receiver sizes. When this is the case, Dr. Harrison can modify the Wedge mouthpiece on the lathe to accommodate the different receiver.

The last question asked how this design improves upon the design of traditional mouthpieces. This is a difficult question because the Wedge mouthpiece does not necessarily improve upon traditional design, but is considered by its creator to be a complete departure from it. It takes the characteristics that everybody knows, such as a narrow rim producing greater flexibility, and takes away the downside, in this case comfort and reduced circulation, by finding a working compromise, in this example, having the rim diameter not be the same all the way around. The Wedge mouthpiece is efficient like a small diameter mouthpiece due to the horizontal axis of the oval cup and rim, but does not lose flexibility or constrict the sound quality like most small diameter mouthpieces due to the larger diameter and deeper cup on the vertical axis and the ability of the lateral sides of the embouchure to move. The Wedge design takes concepts that have been around for years in terms of what works and uses them in combination in order to reduce the disadvantages while enhancing the advantages.

The Wedge is also a complete departure from the idea that a mouthpiece should be form-fitted to the embouchure. The top to bottom curve conforms to the shape of the teeth, which makes it comfortable, while the sides slope away from the embouchure. This rim and cup shape takes all the good design elements of an existing mouthpiece and enhances them to improve efficiency for about 80-90% of players. Most of the

players who it does not work for use a drawn-back smiling embouchure which uses pressure to ascend. The Wedge mouthpiece does not work well for those who use pressure and muscle the sound.

Everybody's muscular structure is unique so there is no mouthpiece that will work perfectly for every trumpet player. Most people can tell within an hour or two if the Wedge mouthpiece will work for them. At most, a person should know within a day or two. Dr. Harrison does not believe a person should have to learn to play a mouthpiece. A mouthpiece should make things easier, not more difficult.

## Chapter 4: Conclusions

### Summary

This study investigated the evolution of trumpet mouthpieces produced by North American manufacturers. In order to give context, a historical account was given of early 20<sup>th</sup> century manufacturers up to the present. Previous scientific studies were investigated. Interview questions were formulated in order to explore mouthpiece design through the lens of modern mouthpiece manufacturers. The interviews have been summarized and results have been compiled.

The rim design of Lynch's Asymmetric mouthpiece is different from all the others. It uses extra metal to support the lower lip which, according to Henderson's theory of an upper lip vibrating against a fixed lower lip, enhances the range. Harrison's Wedge rim is also very different. It is based on Van Cleave's research about the benefits of a dental wedge enhancing range and endurance in trumpet players.

The rims of Curry, Pickett, and Warburton mouthpieces are all radially symmetrical, unlike Lynch's Asymmetric and Harrison's Wedge mouthpiece. Lynch and Pickett use flatter rims in order to provide comfort to players. Curry and Warburton offer both flat and rounded rim designs. Harrison utilizes a rounded rim. All of the manufacturers agree that the rim width has a major effect on the comfort of the mouthpiece. Harrison, Pickett, Curry, and Warburton all believe that the inside diameter of the rim is very important, and that a larger inside diameter is commonly used by orchestral players, whereas a smaller inside diameter is generally used by commercial players.

All of the manufacturers agree that the cup is very important in the determination of tone color. Curry, Pickett, and Warburton each offer numerous cup designs in order to allow trumpeters to choose what works best for their individual playing needs. Lynch of Asymmetric mouthpieces used a response function to calculate the ideal cup for endurance and range. He uses that cup shape in three different depths on all of his mouthpieces. Dr. Harrison of Wedge mouthpieces uses an oval shaped mouthpiece with a lateral dip. The vertical axis, which is wider than the horizontal, gives the mouthpiece the dark sound associated with larger cups. This is combined with the smaller horizontal axis, which gives the mouthpiece the efficiency of smaller cups. All Wedge mouthpieces incorporate this cup design.

The alpha angle is not considered in Lynch's and Warburton's designs. Lynch's reason for this is that the term is descriptive, not prescriptive. It describes something that is already there as a result of design concepts, but does not inform the design concepts. Warburton considers it a bad term because the mouthpiece is composed of curves and arcs, not sharp angles.

Curry, Pickett, and Harrison do consider the alpha angle in their designs. Curry suggests that the function of an alpha angle still applies, whether there is a straight line or a curve. The curve makes it more difficult to calculate. Pickett designs all of his mouthpieces with a fairly consistent alpha angle, except for extremely shallow mouthpieces, in order for them to feel the same. This makes it easy to transition from one of his mouthpieces to another. Curry and Harrison both describe the importance of the alpha angle in relation to lip intrusion. Harrison uses a lower alpha angle than standard mouthpiece counterparts in order to allow for more lip intrusion, which is

needed because of the cup design. Curry offers cups with different alpha angles in order to accommodate many players.

Curry, Pickett, and Harrison each cite a #27 throat as the most commonly used by trumpet players. Lynch's Asymmetric mouthpieces are only produced with a #25 throat in order to provide a bigger sound when balanced with the rim and cup. Harrison offers a #25 and #27 throat. Since the rim and cup design creates more resistance than a standard cup, many players like the bigger throat. Curry offers throat sizes #25 through #28 in order to accommodate more players. Pickett and Warburton both offer a variety of throat sizes as well. Pickett states that many players gravitate toward what has worked for them in the past. All agree that smaller throats have more resistance and open throats are more free-blowing. Pickett and Harrison agree that longer, tighter throats provide better slotting whereas open throats make the slots wider. All also note that a larger throat creates a darker sound and a smaller throat creates a brighter sound.

Pickett and Warburton both note a connection between throat and backbore. Warburton asserts that they do essentially the same thing, but in inverse proportion. All manufacturers agreed that a larger, curved backbore produces a darker sound and is frequently used by symphonic players. A straighter, narrower backbore produces a brighter sound favored by commercial players. Pickett and Curry also mentioned the important function the throat serves in balancing the cup. The cup, backbore, and throat work together to determine the sound and resistance characteristics of the mouthpiece.

All manufacturers except Curry define the exterior shank taper as being Morse #1. Curry states that the taper is not exactly a Morse taper, but is extremely close to it. This rate of taper is an industry standard that was put in place by Vincent Bach in order



to allow all mouthpieces to work with all trumpets. Curry, Pickett, and Warburton mentioned the fact that the external shank taper is a factor in determining the mouthpiece gap.

Lynch, Pickett, and Warburton offer only one length of mouthpiece which is uniform throughout the mouthpiece line. Pickett adds that the internal air volume is more important than the length. The internal air volume is affected by length, cup depth, and backbore size. Curry believes that the length should complement the length of the trumpet. Harrison agrees with Monette's argument that today's trumpets require shorter mouthpieces and offers several different length mouthpieces.

The venturi was believed to be located in two different places. Lynch and Harrison define the venturi to be the same as the throat, which has been previously discussed. Curry, Pickett, and Warburton define the venturi as the internal exit diameter of the mouthpiece. Curry believes it affects intonation and sound quality. Warburton believes it affects flexibility. All three cite it as an important area in terms of resistance and freeness of blowing. Pickett adds that it is an incredibly sensitive area of the mouthpiece. Curry believes that the venturi should be close in diameter to the entrance venturi of the leadpipe whereas Pickett disagrees with this and believes that finding the correct venturi is a matter of finding the correct balance between the mouthpiece, player, and instrument.

Curry, Pickett, and Warburton agree that having the ideal gap has a huge effect on trumpet playing. A gap that is too small lacks brilliance whereas a gap that is too large sounds stuffy. There is general disagreement over the effect on slotting and articulation. Harrison believes that this is because people go about adjusting the gap in

various ways. For example, using Reeves sleeves changes the gap and the exit diameter thickness. It is not known which of these variables is responsible for the changes a player experiences when using them. Lynch theorizes that the changes experienced when a player adjusts gap are a result of changes in air pressure as air passes through it. Harrison and Lynch believe that changing the gap causes only a negligible change which is not noticeable to most trumpet players.

All of the manufacturers agree that brass is the standard material choice and has several advantages. It produces a good trumpet sound, is easy to machine, and easy to acquire. All of Lynch's mouthpieces are made of brass. He has consulted research which scientifically determines that all metals produce the same quality of sound, and he dislikes the sound of plastic.

Curry and Pickett have worked with copper. Pickett claims copper gives the mouthpiece a brighter sound which lead players like. Curry adds that it is difficult to machine due to a stringy texture. Curry has experimented with nickel silver, which is also difficult to machine. Stainless steel has been used by Curry and Harrison. This material provides a very bright sound with great projection and response, but can be too bright for some players. Both companies design mouthpieces with interchangeable parts so that the stainless steel top or bottom can be combined with another material. Curry mentions that stainless steel takes much longer to machine, but possesses a passive corrosion resistant covering.

Pickett, Warburton, and Harrison offer polymer mouthpieces and tops as well. Pickett and Warburton specify that this can be either Delrin or Lexan. Lexan provides more grip than Delrin. All three describe these as darker, but lacking brilliance. They

are often used by players with metal allergies. Harrison adds that these rims provide the player with great response, especially at softer dynamics. In order to get more brilliance out of a polymer mouthpiece top, Harrison suggests combining it with a stainless steel backbore.

Pickett and Warburton each offer a type of hard rubber mouthpiece as well. Pickett's is called Ebonite and Warburton's is Warbonite. Warburton describes this as the closest non-metal material comes to a sounding like a brass mouthpiece. Again, it is a good option for those with metal allergies.

All of the mouthpiece designers agree that the plating has no effect on the sound quality or playing characteristics of the instrument. It is there to protect the player against toxic components of brass and provide players with a specific feel. Lynch uses only silver plating. This is because it possesses a quality that prevents bacteria from living on it. The other manufacturers agree that silver is the most common choice. Each also offers gold which is described by all as smoother and more slippery. Warburton offers to roughen the gold in order to aid players with dry embouchures but who need to play on gold because of an allergy to silver. Pickett offers zirconium-based plating which is a hypoallergenic option for those with metal allergies. Stainless steel mouthpieces are not toxic and do not need to be plated, though their feel is inconsistent according to Harrison and can be plated in order to achieve a consistent feel.

Of those who participated in this study, Harrison is the only manufacturer who designs mouthpieces specifically for B-flat and C trumpets. These were designed with different lengths for the purpose of better intonation. His interchangeable shank system allows a player to use different backbore lengths on the same cup to make switching

between trumpets easier. Pickett does not design his mouthpieces specifically for B-flat or C, but does recognize that some internal volumes work better than others on each instrument. Curry mentions that C trumpets usually use a mouthpiece with a larger throat, but that besides that, they are not substantially different. Warburton also does not design specifically for either trumpet. Lynch designed his mouthpieces based on the B-flat trumpet. He does not have a line of mouthpieces for the C trumpet but suggests that adjustments could be made for intonation, however further research would be needed to verify that.

There was agreement among all the mouthpiece manufacturers that commercial mouthpieces tend to have shallow cups, straighter and narrower backbores, and smaller throats than orchestral mouthpieces. This is to allow the orchestral trumpet player to have a darker, fuller sound and the commercial trumpet player to have a brighter, more cutting sound. Lynch also adds weight to his orchestral mouthpiece to aid the production of the darker sound. Warburton suggests a thinner rim is often used on orchestral mouthpieces. Harrison recommends that commercial players experiment with their choice in material. A stainless steel top can add the brilliance and projection many lead players desire.

Lynch has created a mouthpiece with characteristics in between his classical and his lead mouthpiece which he suggests crossover players use. The other manufacturers believe a different mouthpiece should be used. Curry and Warburton recommend keeping the same rim so that the feel of the mouthpiece is the same. Curry also makes mouthpieces with similar cups that are altered slightly in order to sound brighter but feel the same as the orchestral mouthpiece. Pickett and Harrison do not believe the rim or

cup of a commercial mouthpiece need to be related to the orchestral mouthpiece. They believe it is better for an orchestral musician to become accustomed to a commercial mouthpiece for use during commercial engagements since they will make their job much easier.

Most of the mouthpiece manufacturers interviewed did not take modern innovations in trumpet design into consideration. Curry mostly ignores what trumpet manufacturers do, but does address that depending on the trumpet, a mouthpiece could need to be heavier or lighter. Warburton suggests that most of the trumpet innovations happening right now make the trumpet worse, such as heavyweight trumpets. He does not design mouthpieces for that type of trumpet. Harrison is the only one who did take modern innovations in trumpet design into consideration. He believes that the primary innovation is that trumpets are now better in tune. If this is the case, they can often be played with a full length mouthpiece, rather than the shorter ones suggested for C trumpet and some B-flat trumpets. He also recognizes that some trumpets use deeper receivers or proprietary receiver sizes and will customize mouthpieces to work for players with such equipment.

Of the five manufacturers interviewed, two of the designs required the mouthpiece to be oriented a specific way: Lynch's Asymmetric and Harrison's Wedge. These two, as well as Warburton, cited an increased range to be an element of their design which improved upon traditional design. Harrison and Lynch both made claims of improved endurance as well. Curry and Pickett both emphasized the exceptionally high quality of their mouthpieces and the fact that the mouthpieces are extremely

consistent from one to the next. Warburton also mentioned comfort as an aspect that is better in his design than traditional mouthpieces.

### **Conclusions**

All of the subjects interviewed for this study except Lynch claimed that different metals produce noticeably different sound and playing characteristics. This is in direct contradiction to the only study conducted on the use of different materials for trumpet mouthpieces by Francis F. Wilcox in 1957. The tones compared in Wilcox's study were produced using a "mechanical embouchure" and analyzed by electrical equipment.<sup>168</sup> The human element was missing. The player testing part of this study did show that the players who tested the mouthpieces had preferences among the metal mouthpieces tried, however it was assumed that this was due to properties such as slight changes in the amount of air pressure required to play the mouthpieces rather than the tone. Wilcox concluded that the only discernable tone difference in mouthpieces made of different material was between plastic and metal mouthpieces.<sup>169</sup>

None of the interview subjects of this study mentioned a difference in air pressure required to play the instrument as a relevant or noticeable effect on metal mouthpiece material choice. Of the four who use different materials, all claimed that there was a significant difference in tone quality, especially in regard to stainless steel which is described as much brighter than brass and often used by lead players for that reason. Harrison described a difference in the playing characteristics of the stainless steel mouthpieces as well. Because of this, it is clear that the analysis with electrical

---

<sup>168</sup> Wilcox 1957, 36

<sup>169</sup> Ibid., 127

equipment and a mechanical embouchure was not enough to definitively prove that no difference in sound quality existed among the types of metal tested.

Previous studies about mouthpiece design did not address the length of the mouthpiece as a design aspect with an effect on the playing characteristics of the instrument. Two of the interview subjects, Harrison and Curry, offer mouthpieces of different lengths. The reason for this is that the length of the mouthpiece affects the intonation of the instrument. Using a shorter mouthpiece on higher pitched trumpets (C trumpet, E-flat trumpet, etc) allows out of tune partials to become more in tune. Pickett is familiar with this concept, but adds that it is the overall internal volume, which takes the length, cup depth, and backbore size into account, that causes this effect rather than the length alone.

Many of the innovations described had similar purposes to those which came before. Vincent Bach reported that his mouthpiece added a fifth to his range. Harrison and Lynch both claim that their designs significantly increase the range of the player past that of a traditional Bach mouthpiece. Warburton also describes an increase in range as a consideration for his commercial mouthpiece designs. Bach desired to create a huge line of standard mouthpieces so that there would be an option available to all players without requiring customization. Pickett and Warburton also have very large standard lines in effort to satisfy all players, though they offer custom services as well.

The background of all of the interview subjects includes trumpet performance. Many of the mouthpiece designers of the past were trumpet players as well and some, such as Vincent Bach, also had experience in mechanical engineering. Of the interview subjects, three had similar backgrounds to this. Pickett also has a degree in mechanical

engineering, though his Master's degree focused primarily on acoustics. Curry was educated as a trumpet performer but has much experience experimenting with mouthpiece design. Warburton also was a trumpet performer and gained experience working with other mouthpiece designers such as Giardinelli.

Dr. Harrison's background is in medicine. He contributes his understanding of workings of the human body to mouthpiece design. This background in medicine has brought about design changes in order to enhance endurance, in part by optimizing circulation. This concept is novel and inspired by specialization in an area outside of trumpet performance.

Lynch worked as a physicist and nuclear engineer. He applied concepts from his work at NASA to his designs including statistical inference and resonance functions. Previous to Lynch, nobody had applied these concepts to trumpet mouthpiece design. The addition of people outside of the fields of music and mechanical engineering leads to mouthpiece designs based on concepts not previously considered.

### **Further Research**

Because of the fact that the majority of the mouthpiece manufacturers disagree with Wilcox's conclusion that there is no difference in sound quality among different metals used to make mouthpieces, a further study on this subject could yield new results.

Mouthpiece mass was not addressed in this study. However, several of the manufacturers interviewed have mentioned that they produce mouthpieces of different weights. A primary reason given for this is that more mass darkens the sound. Curry suggested that certain weight mouthpieces are needed to balance certain trumpets.



Wilcox's study explored sound quality and response differences when mouthpieces were skeletonized, but no other aspects which mass could affect were explored. Darrington's study addressed the difference in an audience's perception of sound quality when weight was added, but again, other effects such as intonation, response, and relation to the instrument were not considered. A study addressing the effect of increasing and decreasing mouthpiece mass in regard to all aspects of playing has yet to be done.

While conducting this study, two manufacturers expressed opposing opinions about the relationship of the leadpipe venturi of the trumpet to the exit venturi of the mouthpiece. Curry suggested that they should be approximately the same diameter whereas Pickett did not subscribe to that theory. This area of mouthpiece and trumpet design requires further research.

### **Final Thoughts**

The data gathered in this study provides the modern trumpet player with information regarding the ways in which five current mouthpiece manufacturers are creating products to meet present needs. These mouthpieces are used as tools to bring the trumpet player closer to his or her musical goal.

## Bibliography

### Books

*Bach Mouthpiece Manual*. Elkhart, IN: Selmer, 2014.

<http://www.bachbrass.com/pdf/AV6001%20Bach%20Mpce%20Manual.pdf>

(accessed February 17, 2014).

Benade, Arthur. *Fundamentals of Musical Acoustics*. New York: Dover Publications, Inc., 1990.

Benade, Arthur. *Horns, Strings, and Harmony*. New York: Dover Publications, Inc., 1992.

Hickman, David. *Trumpet Pedagogy*. Chandler, AZ: Hickman Music Editions, 2006.

Peterson, Ben. *Trumpet Science: Understanding Performance Through Physics, Physiology, and Psychology*. Wausau, WI: Peterson Music, 2012.

*Schilke Mouthpiece Catalog*. Melrose Park, IL: Schilke Music Products, Inc., 2014.

<http://www.schilkemusic.com/files/2011SchilkeMpcCatalog.pdf> (accessed

February 17, 2014).

Tarr, Edward. *The Trumpet*. Translated by S.E. Plank and Edward H. Tarr. Chandler, AZ: Hickman Music Editions, 2008.

### Articles

Backus, John and Hundley, T.C. "Harmonic Generation in the Trumpet." *The Journal of the Acoustical Society of America* 49 no. 2 (February 1971): 509-519.

Beale, Franklin. "The Story of Vincent Bach." *New York Brass Conference for Scholarships* 5 (1976): 8-9.

- Blackburn, Clifford. "Trumpet Modifications and Repair: Mouthpiece Gap." *International Trumpet Guild Journal* 4 (May 1979): 12.
- Blackburn, Clifford. "Trumpet Modifications and Repair: Louisville Leadpipe; Mouthpiece Throat Sizes." *International Trumpet Guild Journal* 3 (February 1978): 10-11.
- Bonvissuto, Bruce, Allan Colin, Mark Gould, and Sam Pilafian. "Brassmen Need Leadership in Brass Manufacturing: Interview with Robert Giardinelli." *New York Brass Conference for Scholarships Featuring: Robert Giardinelli* (February. 23, 1985): 12-15.
- Camus, Raoul F. "Bellstedt, Herman." *Grove Music Online. Oxford Music Online*. Oxford University Press, accessed February 17, 2014, <http://www.oxfordmusiconline.com/subscriber/article/grove/music/A2083823>.
- Chapman, Robert C. "Mouthpiece Throats, Cups and Calculations." *International Trumpet Guild Journal* 26 no. 2 (January 2002): 40-41.
- Colin, Charles. "Conversations Between Dr. Renold Schilke and Dr. Charles Colin." *New York Brass Conference for Scholarships: The Golden Age of Trumpet: Dr. Renold Schilke* (1983): 21-23.
- Colin, Charles. "Interview with Robert Giardinelli." *New York Brass Conference for Scholarships* 5 (1976): 20-21.
- Colin, Charles. "Robert Giardinelli: Tape Talk with Charles Colin." *New York Brass Conference for Scholarships Featuring: Robert Giardinelli*. (February. 23, 1985): 3-11 and 22-27.

- Crown, Tom. "Christian Rodenkirchen and the First Chicago Symphony Orchestra Trumpet Section." *International Trumpet Guild Journal*. 33 no. 4 (June 2010): 20-27.
- Fladmoe, Gary G. "The Legacy of Vincent Bach." *New York Brass Conference for Scholarships* 5 (1976): 10-13.
- Gelles, George and Michael Meckna. "Goldman, Edwin Franko." *Grove Music Online*. *Oxford Music Online*. Oxford University Press, accessed February 17, 2014, <http://www.oxfordmusiconline.com/subscriber/article/grove/music/11381>.
- Haley, Robert. "Comparing Mouthpiece Rims and Cups." *International Trumpet Guild Journal* 33 no. 2 (January 2009): 52-53.
- Henderson, Hawyard W. "An Experimental Study of Trumpet Embouchure." *The Journal of the Acoustical Society of America* 14 (1942): 58-64.
- Irish, John. "International Trumpet Guild 2012 Conference Reports: David Monette Presentation." *International Trumpet Guild Journal* 37 vol. 1 (October 2012): 15
- Koehler, Elisa. "International Trumpet Guild 2007 Conference Reports: Monette: Design, Fabrication, and Performance." *International Trumpet Guild Journal* 32 vol. 1 (October 2007): 25
- Libs, Jean Moorehead. "The Perfect Match: Trumpet Meets Mouthpiece: An Interview with Phyllis Stork and Bob Malone." *International Trumpet Guild Journal* 18 (December 1994): 42-28.
- Lynch, John. "The Asymmetric Trumpet Mouthpiece." *International Trumpet Guild Journal* 20 (February 1996): 52-55.

- Meredith, Henry. "The 1979 ITG Conference: Bob Reeves." *International Trumpet Guild Journal* 4 (October 1979): 40.
- Moore, Thomas. "The Science of the Mouthpiece: What Is and Isn't Known." *International Trumpet Guild Journal* 30 (January 2006): 57-58.
- Lewis, H. M. "Renold Schilke: Master Craftsman, Player, and Teacher." *International Trumpet Guild Journal* 6 (May 1980): 6-9.
- Olson, R. Dale. "Chronology of Invention: The Trumpet Mouthpiece Part 1." *International Trumpet Guild Journal* 34 no. 2 (January 2010): 63-70.
- Olson, R. Dale. "Chronology of Invention: The Trumpet Mouthpiece Part 2." *International Trumpet Guild Journal* 34 no. 3 (March 2010): 53-61.
- "Schilke Brass Clinic: The Physics of Inner Brass and the Acoustical Effects of Various Materials and their Treatment." *New York Brass Conference for Scholarships: The Golden Age of Trumpet: Dr. Renold Schilke* (1983): 12-15.
- Smith, André M. "Robert Giardinelli (1914-1996): Four Decades of Excellence in New York." *International Trumpet Guild Journal* 20 (December 1996): 13-34.
- Smith, André M. "The Life and Work of Vincent Bach (née Vincenz Schrottenbach) 1890-1976: The Early Years to World War II." *International Trumpet Guild Journal* 18 (December 1994): 5-35.
- Smith, André M. "The Life and Work of Vincent Bach (1890-1976): 1941-1976 (and Beyond)." *International Trumpet Guild Journal* 18 (February 1995): 5-34.
- Stork, John and Phyllis. "Trumpet Modifications and Repair: Basic Guidelines for Mouthpiece Selection." *International Trumpet Guild Journal* 11, no. 2 (December, 1986): 34-37.

- Tarr, Edward H. "Bach, Vincent." *Grove Music Online. Oxford Music Online*. Oxford University Press: accessed February 2, 2014, <http://www.oxfordmusiconline.com/subscriber/article/grove/music/01692>.
- Tarr, Edward H. "Schilke, Renold O." *Grove Music Online. Oxford Music Online*. Oxford University Press, accessed February 20, 2014, <http://www.oxfordmusiconline.com/subscriber/article/grove/music/24857>.
- Teck, Kathy. "Giardinelli: From One-Man Shop to International Pro Center." *New York Brass Conference for Scholarships Featuring: Robert Giardinelli*. (February 23, 1985): 28-31.
- "The Influence of Dr. Schilke's Work on the Trumpet." *New York Brass Conference for Scholarships: The Golden Age of Trumpet: Dr. Renold Schilke* (1983): 18-20.
- White, Jack. "Specific Changes in the Trumpet Brought About by Schilke." *New York Brass Conference for Scholarships: The Golden Age of Trumpet: Dr. Renold Schilke* (1983): 16-18.
- Zicari, Massimo; Jennifer MacRitchie; et all. "Trumpet Mouthpiece Manufacturing and Tone Quality." *The Journal of the Acoustical Society of America* 134 no. 5 (November 2013): 3872-3886.

### **Dissertations and Theses**

- Bennett, Conte Jay. *Selection of Trumpets and Mouthpieces by Classically-Trained Players for Commercial Music Performance*. D.M.A. diss., University of Miami, 2006.

- Darrington, Ian A. *Trumpet Mouthpieces –An In-Depth Study*. Ph.D. diss., University of Liverpool, 2004.
- Fladmoe, Gary Gardner. *The Contributions to Brass Instrument Manufacturing of Vincent Bach, Carl Geyer, and Renold Schilke*. Ph.D. Thesis, University of Illinois at Urbana-Champaign, 1975.
- Hallquist, Robert Eugene. *A Comparative Study of the Effect of Various Mouthpieces on the Harmonic Content of Trumpet Tones*. Ph.D. diss., University of Minnesota, 1979.
- Kusinski, John Stanley. *The Effect of Mouthpiece Cup Depth and Backbore Shape on Listeners' Categorizations of Tone Quality in Recorded Trumpet Excerpts*. Ph.D. diss., University of Miami, 1984.
- Malek, Vincent. *A Study of Embouchure and Trumpet-Cornet Mouthpiece Measurements*. Ph.D. diss., Northwestern University, 1953.
- White, Jack O. *Renold Otto Schilke: His Contributions to the Development of the Trumpet*. D.A. diss., New York University, 1980.
- Wilcox, Francis F. *An Investigation of Certain Properties of Selected Materials for Trumpet Mouthpieces*. Ph.D. diss., Northwestern University, 1957.

### **Interviews**

- Curry, Mark. Interview with author. Phone Interview. April 11, 2014.
- Harrison, Dave. Interview with author. Phone Interview. April 3, 2014.
- Lynch, John. Interview with author. Phone Interview. April 10, 2014.
- Picket, Peter. Interview with author. Phone Interview. April 4, 2014.
- Warburton, Terry. Interview with author. Phone Interview. April 11, 2014.

## Websites

- “Bach History.” <http://www.bachbrass.com/history/> (Accessed February 14, 2014).
- “Bob Reeves Brass Mouthpieces.” <http://www.bobreeves.com/> (Accessed February 14, 2014).
- “Conn-Selmer.” <http://www.conn-selmer.com/en-us/> (Accessed April 11, 2014)
- “Curry Precision Mouthpieces.” <http://www.currympc.com/> (Accessed January 14, 2014).
- “David G. Monette Corporation.” <http://www.monette.net/newsite/> (Accessed March 22, 2014).
- “GR Technologies.” <http://www.grmouthpieces.com/> (Accessed March 16, 2014)
- “John Parduba & Sons.”  
<http://www.grandcanyontuberadio.com/instrument/parduba/parduba.html>  
(Accessed February 11, 2014).
- “Pickett Brass.” <http://www.pickettbrass.com/> (Accessed January 14, 2014).
- “The New Asymmetric – Range Enhancing Trumpet Mouthpieces.”  
<http://www.asymmetric-mouthpiece.com/> (Accessed March 16, 2014).
- “The Wedge Mouthpiece.” <http://www.wedgemouthpiece.com/> (Accessed March 16, 2014).
- “Warburton Music Products.” <http://www.warburton-usa.com/> (Accessed January 14, 2014).



## Appendix A: Interview Questionnaire

- 1.) If we break the mouthpiece into the constituent parts (listed below), please explain the function of each part according to your design concepts.
  - a.) rim
  - b.) cup
  - c.) alpha angle (if relevant)
  - d.) throat
  - e.) backbore
  - f.) exterior shank taper
  - g.) overall length
  
- 2.) Please discuss the importance and function of the following:
  - a.) venturi
  - b.) gap
  - c.) material from which the mouthpiece is made
  - d.) plating
  
- 3.) What considerations, if any, do you make when designing mouthpieces for use on the B $\flat$  versus the C trumpet?
  
- 4.) What considerations, if any, do you make when designing mouthpieces for the primarily orchestral versus primarily commercial trumpeter?
  
- 5.) What considerations, if any, do you make when designing mouthpieces for the player who must cross-over from orchestral to commercial playing?
  
- 6.) Do modern innovations in trumpet design impact your concepts of mouthpiece design? If so, in what way?
  
- 7.) In conclusion, please state how your concepts of mouthpiece design improve upon the traditional mouthpiece produced by previous manufacturers.

## Appendix B: Glossary of Terms

- Bite Radius** – The inner rim diameter of the mouthpiece which contacts the lips. This area of the mouthpiece holds the mouthpiece against the lips. A smaller radius produces a sharper bite which aids attack, but can be uncomfortable. A larger radius has the opposite effect. Softer bites, caused by larger bite radiuses, can cause the cup to feel wider.
- Center (Pitch)** – ideal resonance achieved on a specific pitch.
- Coupled Resonator** – Two resonators working in conjunction with one another in a system.
- CNC Lathe** – Computer numerical controlled lathe. This machine is programmed to create objects based on the user’s inputted design. The precision of these machines is far superior to previous methods of mouthpiece manufacturing.
- Damping response** – an engineering term used to describe the way that oscillations in a system decay after a disturbance.
- Helmholtz Resonator** – an object which contains a cavity of air which resonates to produce a pitch when a force acts upon it to create pressure oscillations. Developed by Herman L. F. von Helmholtz .
- Input impedance** – acoustical impedance is how much sound pressure is generated by vibration of molecules of a particular acoustic medium at a given frequency.
- Morse #1 Taper** – a taper of .0499” per inch. It is .4750 inches at the large end and .3690 inches at the small end. The Morse #1 taper is 2.13 inches long.
- Open (backbore)** – fast taper which evens out before the end.
- Partial Series** – naturally occurring notes on a trumpet or other brass instrument which can be achieved without using valves or slides.
- Resonant frequency** – also called the “popping frequency” when used in reference to a mouthpiece. The frequency at which an object naturally resonates.
- Skeletonize** – remove metal from the exterior of the mouthpiece resulting in a lighter mouthpiece with an exterior shape conforming to that of the cup.
- Slotting** – moving easily between notes at their ideal resonance without impurities in between them.

Statistical inference – a process used in order to draw conclusions from a data set which is subject to random variation.

Tight (backbore) – cylindrical with a gradual taper.

## Appendix C: IRB Approval



### Institutional Review Board for the Protection of Human Subjects Approval of Initial Submission – Expedited Review – AP01

**Date:** February 18, 2014

**IRB#:** 3940

**Principal Investigator:** Katherine L. Klinefelter

**Approval Date:** 02/17/2014

**Expiration Date:** 01/31/2015

**Study Title:** MODERN INNOVATIONS IN AMERICAN TRUMPET MOUTHPIECE DESIGN

**Expedited Category:** 6 & 7

**Collection/Use of PHI:** No

On behalf of the Institutional Review Board (IRB), I have reviewed and granted expedited approval of the above-referenced research study. To view the documents approved for this submission, open this study from the *My Studies* option, go to *Submission History*, go to *Completed Submissions* tab and then click the *Details* icon.

As principal investigator of this research study, you are responsible to:

- Conduct the research study in a manner consistent with the requirements of the IRB and federal regulations 45 CFR 46.
- Obtain informed consent and research privacy authorization using the currently approved, stamped forms and retain all original, signed forms, if applicable.
- Request approval from the IRB prior to implementing any/all modifications.
- Promptly report to the IRB any harm experienced by a participant that is both unanticipated and related per IRB policy.
- Maintain accurate and complete study records for evaluation by the HRPP Quality Improvement Program and, if applicable, inspection by regulatory agencies and/or the study sponsor.
- Promptly submit continuing review documents to the IRB upon notification approximately 60 days prior to the expiration date indicated above.
- Submit a final closure report at the completion of the project.

If you have questions about this notification or using iRIS, contact the IRB @ 405-325-8110 or [irb@ou.edu](mailto:irb@ou.edu).

Cordially,

A handwritten signature in black ink, appearing to read 'E. Laurette Taylor'.

E. Laurette Taylor, Ph.D.  
Chair, Institutional Review Board

## **Appendix D: List of Contact Information for Mouthpiece**

### **Manufacturers Interviewed in this Study**

#### **Asymmetric Mouthpieces**

<http://www.asymmetric-mouthpiece.com/>  
John Lynch  
6716 Candy Lane  
Vermilion, OH 44089  
[johnlynch@asymmetric-mouthpiece.com](mailto:johnlynch@asymmetric-mouthpiece.com)

#### **Curry Precision Mouthpieces**

<http://www.currympc.com/>  
Mark Curry  
(no on-site consultations)  
[mark@currympc.com](mailto:mark@currympc.com)

#### **Pickett Brass**

<http://www.pickettbrass.com/>  
Peter Pickett  
308 North Ashland Ave  
Lexington, KY 40502  
[info@pickettbrass.com](mailto:info@pickettbrass.com)

#### **Warburton Musical Products**

<http://www.warburton-usa.com/>  
Terry Warburton  
2764 US 1  
Mims, FL 32754  
[sales@warburton-usa.com](mailto:sales@warburton-usa.com)

#### **The Wedge Mouthpiece**

<http://www.wedgemouthpiece.com/>  
Dr. Dave Harrison  
3110 W 43<sup>rd</sup> Ave  
Vancouver, BC  
V6N 3J5  
[drdave@wedgemouthpiece.com](mailto:drdave@wedgemouthpiece.com)

## Appendix E: Octave Designation Terminology

This document uses the octave designation system developed and used by the Acoustical Society of America. See the figures below.

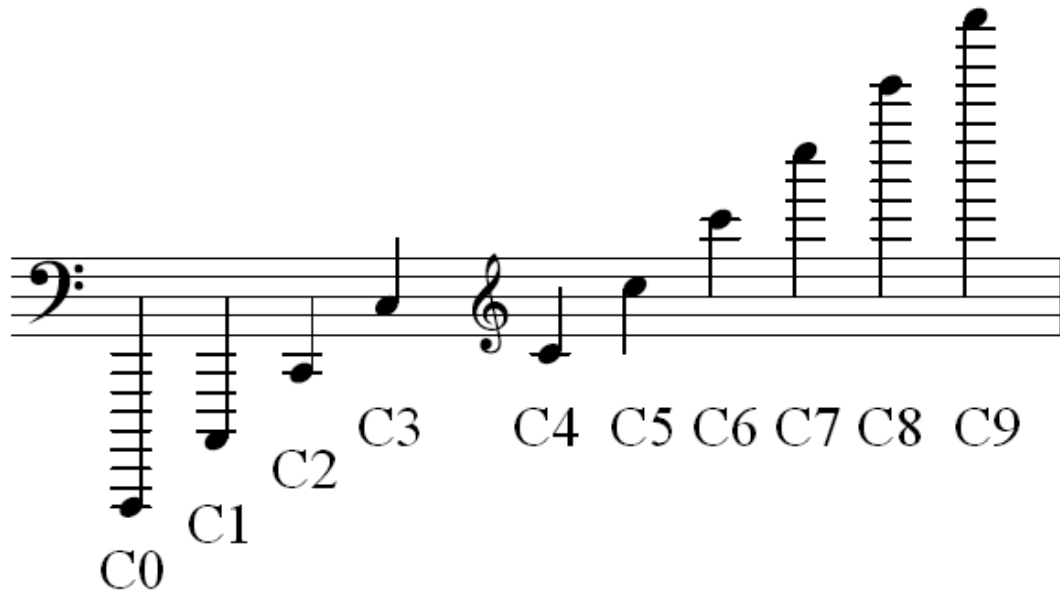

Figure 18 - Octave Designation: All Octaves

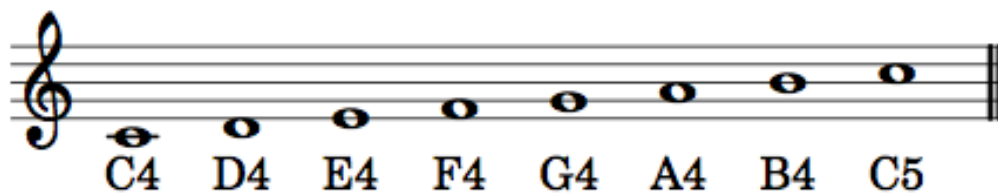

Figure 19 - Octave Designation: C4-C5

## Appendix F: Mouthpiece Throat Sizes

Throat	Size in Inches
#19	0.166
#20	0.161
#21	0.159
#22	0.157
#23	0.154
#24	0.152
#25	0.1495
#26	0.147
#27	0.144
#28	0.1405
#29	0.136

Figure 20 - Throat Sizes (wire gauge)