

THE CONDENSATION OF METHYLAL AND OTHER ACETALS WITH OLEFINS

By

JOHN J. HAWKINS

Master of Science

Oklahoma Agricultural and Mechanical College

Stillwater, Oklahoma

1949

**Submitted to the Faculty of the Graduate School of
the Oklahoma Agricultural and Mechanical College
in Partial Fulfillment of the Requirements
for the Degree of
DOCTOR OF PHILOSOPHY
July, 1952**

THE CONDENSATION OF METHYLAL AND OTHER ACETALS WITH OLEFINS

JOHN J. HAWKINS

DOCTOR OF PHILOSOPHY

1952

THESIS AND ABSTRACT APPROVED:



Thesis Adviser



Faculty Representative



Dean of the Graduate School

ACKNOWLEDGEMENT

The author is indebted to Dr. O. C. Dermer for suggesting this work and for his patient assistance and direction.

This work was made possible by the financial aid given by the Chemistry Department in the form of a graduate assistantship and by the Cities Service Research and Development Company, sponsors of this project, in the form of a fellowship.

The author wishes to express his appreciation to Dr. V. A. Yarborough of Carbide and Carbon Chemicals Company, South Charleston, W. Va., for the determination and interpretation of mass-spectrometer data contained herein.

The guidance of other members of the staff of the Department of Chemistry has been of material assistance throughout the course of these investigations.

TABLE OF CONTENTS

	Page
INTRODUCTION	1
HISTORICAL	2
I. REAGENTS AND PRODUCTS	
Early history	2
Formaldehyde and simple alkenes	4
Formaldehyde and cycloalkenes	9
Formaldehyde and chloro-olefins	11
Formaldehyde and unsaturated alcohols	12
Formaldehyde and unsaturated ethers	12
Formaldehyde and unsaturated acids	12
Formaldehyde and unsaturated acid derivatives	13
Formaldehyde and dienes	13
Other aldehydes and olefins	17
<u>Alpha</u> -chloro ethers and olefins	18
<u>Alpha</u> -chloro esters and olefins	22
Acetals and olefins	22
II. PROPOSED MECHANISMS	28
EXPERIMENTAL	
Methylal and butadiene	35
Methylal and propylene	38
Methylal and isobutylene	43
Diethyl acetal and isobutylene	48
Methylal and styrene	53
Ethylal and styrene	54
Methylal and cyclohexene	56

	Page
Methylal and α -pinene	59
Methylal and acetylene	61
Solid bed catalyst study	62
GENERAL DISCUSSION	64
SUMMARY	67
BIBLIOGRAPHY	68

INTRODUCTION

For several years some members of the department of Chemistry at Oklahoma A. and M. College have held a rather wide interest in the acid-catalyzed Prins type of condensation of olefins with aldehydes or aldehyde-like compounds. While studying the reaction of formaldehyde with butadiene, Kohn (87) noted that methylal, which was presumed to act as a source of formaldehyde in the above reaction, actually reacted to give compounds unlike those claimed in patent literature (6). The present author in a previous thesis (72) reported on this novel reaction after a thorough investigation of the compounds isolated therefrom. A search of the literature indicated that a clear field of investigation had been opened and much work still remained in the further elucidation of this reaction type.

The purpose of this investigation was to study as extensively as possible additional ramifications of this new type reaction, to produce a sound and significant contribution to the presently little known acid-catalyzed reaction between olefins and acetals under anhydrous conditions. In this work the principal effort was toward establishing variability of the reagents rather than optimum conditions because of the limitations both in time and available working equipment needed to extend such a reaction study.

HISTORICAL

I. Reagents and Products

Early History:

The Prins reaction--that is, the reaction involving the acid-catalyzed addition of aldehydes to an olefinic double bond-- was first recorded in 1917, when Prins successfully added formaldehyde into various olefins (137-142). He found that formaldehyde adds into the double bond of such compounds as styrene, anethole, eugenol, and some terpenes in the presence of glacial acetic acid with concentrated sulfuric acid catalyst to yield 1,3-glycols, formals, esters, and unsaturated primary alcohols.

In 1899, Kriewitz (88) had caused formaldehyde and terpenes to condense to form unsaturated primary alcohols; however, no catalyst was used, and consequently the potentialities of such a condensation were not developed until Prins found acid catalysis so successful. Prins (141) has cited this work of Kriewitz and conceivably was guided by it.

Fourneau, Benoit, and Firmenich (53) caused styrenes to react with formaldehyde in the presence of glacial acetic acid and concentrated sulfuric acid and isolated a diester with the formula shown:

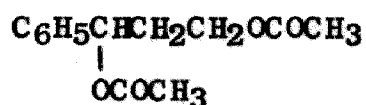

The structure of the ester was proved by hydrolyzing it to a 1,3-glycol--

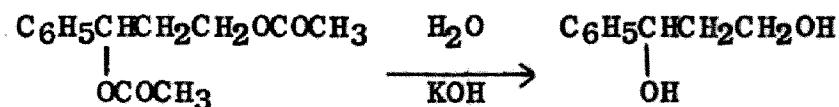

--and preparing the dibenzoate derivative, which melted at 51°. Rupe (153) in 1922 had synthesized this particular 1,3-glycol by hydrogenating α -methylolacetophenone. Since the dibenzoate of this glycol also melted at 51°, the proof that Rupe's glycol was identical with the Prins-derived product was complete.

The initial industrial application of the Prins reaction was claimed in 1930 in a French patent (159) which described the preparation of 1,3-glycols by reaction of olefins with formaldehyde in the presence of acetic and sulfuric acids followed by hydrolysis.

Prins (142) extended the reaction to chlorinated ethylenes. He postulated and experimentally verified a rule governing the orientation of the addition of formaldehyde to substituted ethylenes. The rule as he formulated it states that, in the olefinic bond, that carbon atom which bears the most electro-negative substituents becomes linked to the oxygen of the formaldehyde. For example, he obtained α -chloropropiolactone from the reaction of formaldehyde with trichloroethylene in the presence of concentrated sulfuric acid. He proposed a mechanism now untenable, but the rule did serve to predict the exact

products of the reaction. An interesting sequel to this particular addition is the dehydration of the product of hydrolysis of the lactone to yield α -chloroacrylic acid:

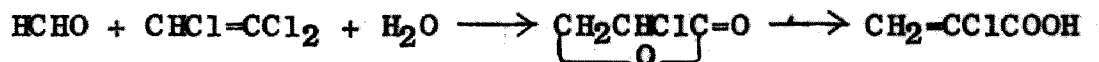

Matti (98) caused cyclohexene to react with formaldehyde in the presence of glacial acetic acid and concentrated sulfuric acid and isolated 1-methylol-2-cyclohexanol as the main product by hydrolysis of the mixture of mono- and diacetates produced. In addition, Matti found other materials which were not identified.

Formaldehyde and Simple Alkenes:

A considerable portion of the literature on these additions has been confined to industrial applications and recorded only in patents. The greatest number of patents have been obtained on the preparation of 1,3-glycols and derivatives thereof such as *m*-dioxanes, diolefins, chlorinated and unsaturated primary alcohols, and 1,3-dihalides.

The production of 1,3-glycols is described in a series of patents (6, 50, 67, 68, 76, 77, 102, 103, 151, 161) dated from 1939 to 1947. The processes are essentially the same and may be represented by the equation:

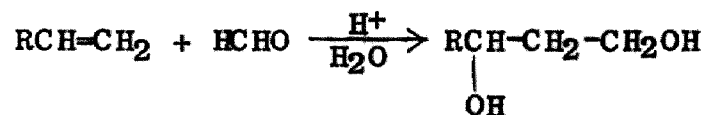

An olefinic hydrocarbon is made to combine with an aldehyde (usually formaldehyde) or aldehyde-yielding reagents (aqueous

formalin, paraformaldehyde or an acetal such as methylal) in the presence of an acid catalyst such as hydrochloric acid, sulfuric acid, a metal halide, or aqueous boron trifluoride. (Results obtained in our work indicate that the above statement is true as regards acetals only if water is present.) The pressure and temperature vary but in general higher pressures and temperatures are required with the lower olefins. The glycols produced may be converted to diolefins (7, 96, 107, 133, 151, 175) by some method of complete dehydration. In these processes, the crude reaction mixture is passed over a dehydrating catalyst such as aluminum oxide (96, 175) or through a dehydrating agent such as concentrated sulfuric acid (7, 107) at high temperatures.

The patented production of formals and m-dioxanes (8, 42, 48, 49, 78, 79, 83, 93, 95, 104, 147, 152, 162, 163) may be considered to be an intermediate stage in the production of 1,3-glycols:

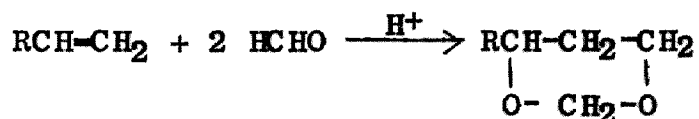

The starting materials are again an olefin or a halogenated olefin, a source of an aldehyde, and an acid catalyst. As a rule, operating temperatures are lower and a non-reactive solvent may be used to increase solubility of the olefin.

Under the usual reaction conditions unsaturated primary alcohols are formed (8, 9, 51, 80, 105, 148, 161) when highly unsymmetrical olefins such as trimethylene, isobutylene, and diisobutylene are used as source of the carbon-carbon double bond.

Chlorinated alcohols (51, 80, 81, 82, 113) are produced by reaction of an olefin or an unsaturated alcohol with a source of formaldehyde and hydrochloric acid, usually at an elevated temperature and pressure. This process may be utilized further to prepare 1,3-dihalides (57), but even higher temperatures and pressures are required for reaction.

Shortridge (158) found that the reaction of formaldehyde and styrene with concentrated sulfuric acid catalyst in an inert solvent at room temperature gives a 78% yield of 4-phenyl-1,3-dioxane and no glycol. The yield of the dioxane was increased to 88% by the use of styrene, 37% aqueous formalin and sulfuric acid at reflux temperatures.

The Prins reaction has been carried out at elevated temperatures and pressures with results similar to those obtained under less severe conditions. Reaction between gaseous olefins and aqueous formalin with a zinc-chloride catalyst at high temperatures and pressures has been demonstrated (52, 119, 123). The chief product is the formal of a 1,3-glycol containing one more carbon atom than the original olefin. A water-immiscible solvent in which the olefins and formals are soluble was found to favor the formation of formals and to increase the overall yield. Aqueous hydrochloric acid used as a catalyst in place of zinc chloride produces chlorinated alcohols instead of glycols. Ethylene caused to react with formaldehyde (118) at high temperatures and high pressures yields trimethylene glycol diacetate and the triacetate of 2-methyl-2-hydroxymethyl-1,3-propanediol. No m-dioxane was found but Olsen believes it

may have been lost by washing the reaction mixture with water. This particular reaction is of interest since the trimethylene glycol diacetate serves as an intermediate stage in the synthesis of glycerol (125). Olsen in more recent patents (124-126) claims the formation of allyl alcohol and its esters as well as trimethylene glycol and 2-methyl-2-hydroxymethyl-1,3-propanediol and their esters when ethylene, formaldehyde, an acid catalyst, and an organic solvent are combined under high heat and pressure. Propylene yields the expected products, 4-acetoxytetrahydro-2H-pyran and 1,3-butanediol diacetate (120).

Baker (18) independently repeated the reaction between ethylene and paraformaldehyde at room temperature in an anhydrous mixture of acetic acid and sulfuric acid. The diacetate of trimethylene glycol was isolated and characterized. Some evidence for the formation of the corresponding formal was found.

In addition to the above reaction Baker (20) treats the structural conditions in the olefin which favor the acid-catalyzed addition of formaldehyde to it. In order for an olefin to give satisfactory yields of the 1,3-glycol derivatives, it must be of the type $\text{HRC}'=\text{CH}_2$ or $\text{HR}'\text{C}=\text{CHR}''$, where R' = alkyl or aryl and R'' = alkyl or hydrogen. If the activation resulting from the presence of R' or R'' becomes too great, polymerization and other side reactions reduce the yield of desired product.

Patent literature concerning Prins-type products is gradually being extended to cover the practical utilization of these products. Thus the octane number of motor fuels has been improved by Arundale and Mikeska (10) through the addition of 5% or more of m-dioxanes. Halogenated alcohols and formals are said to be useful as solvents, fungicides, insecticides, flameproofing agents, or intermediates (83).

When formaldehyde and a tertiary olefin are reacted under Prins conditions products are obtained which Munday and Matuszak (110) found to be suitable blending agents for aviation gasolines. Thus 2,3-dimethyl-2-butene gave 2,3-dimethyl-3-hydroxymethylbutene 38%, 4,4,5,5-tetramethyl-m-dioxane 18%, 2-chloro-2,3-dimethylbutane 29% via addition of hydrogen chloride, used as catalyst, to the original olefin, and 14% residue or unidentified material.

Mottern (108) utilized the Prins reaction in the separation of tertiary olefins from hydrocarbon mixtures. The basis of the process lies in the fact that formaldehyde in 25% sulfuric acid reacts selectively with such olefins. Somewhat similar is the use of formaldehyde at 190-270° to stabilize gasolines (5a).

Unsaturated esters have been synthesized by Arundale and Mikeska (11) through the condensation of a tertiary olefin with formaldehyde and anhydrous organic acids or their anhydrides. Effective catalysts for the reaction are metallic halides or metallic salts of halogenated organic acids; the metals

specified are those of the second and fourth groups in the periodic table.

Arundale and Mikeska in continuing their investigations of the acid-catalyzed addition of formaldehyde to olefins have patented a synthesis of 1,3-diols by the addition of an aldehyde to an olefin under pressure with sulfuric acid catalyst (106).

A combination of the Prins reaction with telomerization has been patented recently (4, 27). Paraformaldehyde, styrene, an organic acid, and an acid catalyst yield compounds of the type $\text{RCOO}(\text{CH}_2\text{CHC}_6\text{H}_5)_n\text{OCOR}$, where n is 2 or more.

Formaldehyde and Cycloalkenes:

The most extensive investigation of the Prins reaction was carried out by Olsen and Padberg (116, 117). These workers, repeating the work of Matti (98), caused formaldehyde to react with cyclohexene in glacial acetic acid with concentrated sulfuric acid as catalyst. The products of the reaction were isolated and a reaction scheme was formulated. The chief products of the reaction are the acetates and formals of hexahydrosaligenin (o-hydroxyhexahydrobenzyl alcohol). These compounds are thought to result from the following reaction sequence:

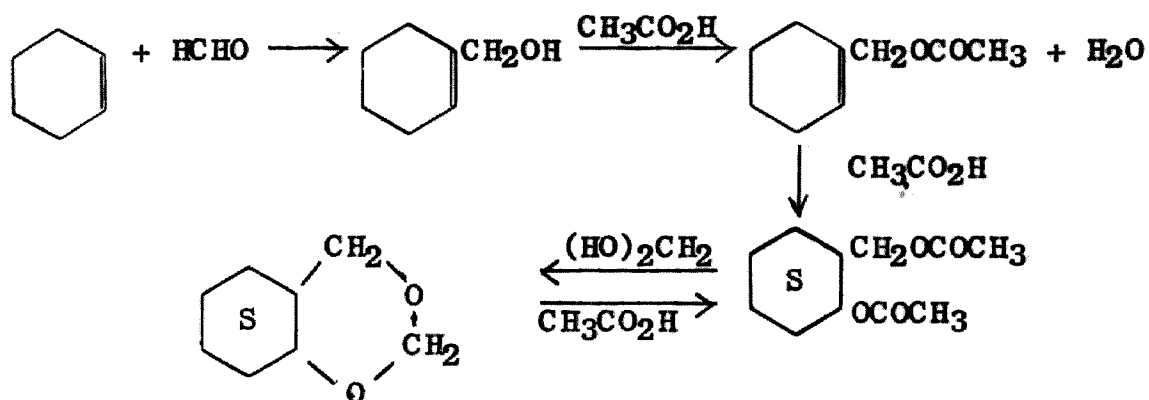

One of the important side reactions is the acid-catalyzed addition of acetic acid into the double bond of cyclohexene:

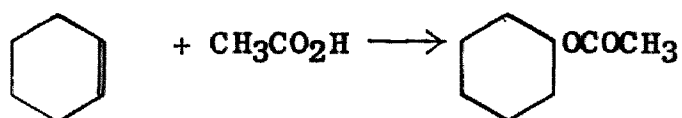

Another important side reaction leads to the production of phthalan derivatives:

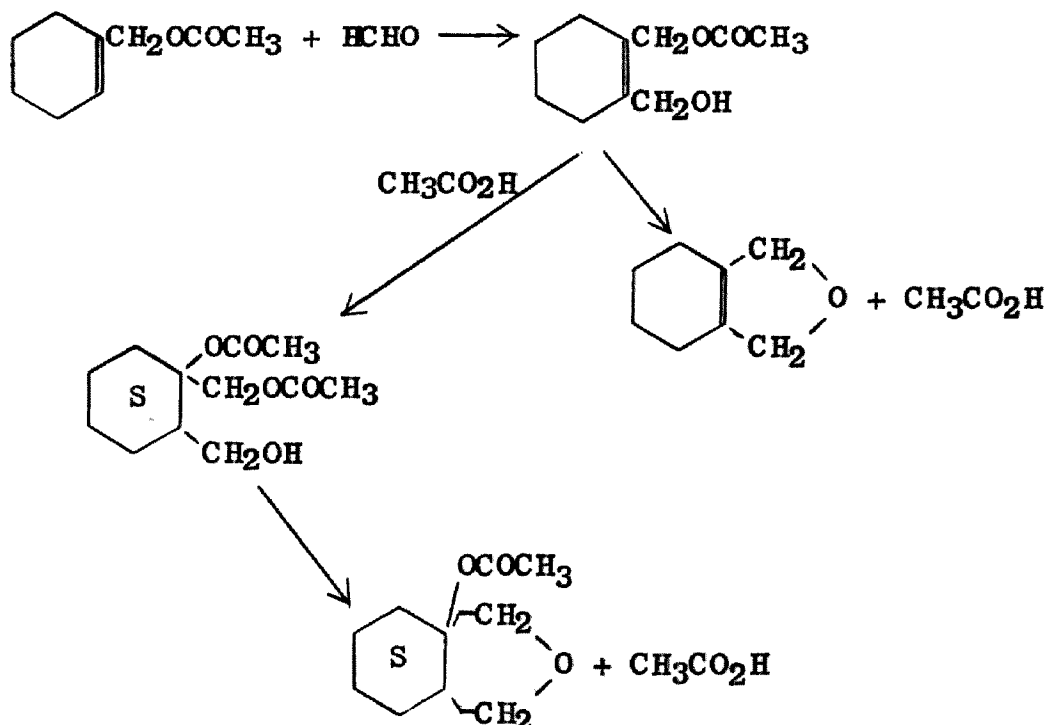

The overall reaction was shown to give a series of products which are all in equilibrium with each other. The addition of any of the known intermediates or side products to a mixture of formaldehyde, glacial acetic acid and concentrated sulfuric acid leads to the same reaction products.

Nenitzescu and Przemetsky (113) caused 2-methylcyclohexene to react with paraformaldehyde in a glacial acetic acid-sulfuric acid mixture and isolated the acetate of 2-methyl-1-cyclohexene-1-methanol and the diacetate of 2-hydroxy-2-methylcyclohexane-methanol. These same workers caused cyclohexene to react with 35% formalin solution in the presence of sulfuric acid to yield small amounts of the formal, α - $\text{OC}_6\text{H}_{10}\text{CH}_2\text{OCH}_2$.

Terpene alcohols have been produced (5, 16, 17, 70, 90, 92) by the use of terpenes as olefins together with a source of formaldehyde and an acid catalyst.

Formaldehyde and Chloro-Olefins:

The condensation of formaldehyde or a polymer thereof with di- or trichloroethylene in the presence of sulfuric acid has been utilized by many workers to produce acrylic or α -chloroacrylic acid (32, 84, 85, 100, 101, 149, 150, 156, 157). An alcohol may be added to the reaction mixture and the acrylic acid separated as its ester.

Price and Krishnamurti (136) found the addition of formaldehyde to allyl chloride to proceed normally, yielding 45% of the expected 1,3-dioxane, which was then cleaved by hydrolysis and acetolysis.

Coffman and co-workers (28) attempted the addition of formaldehyde to tetrafluoroethylene in the presence of much concentrated sulfuric acid at a temperature of 80°. Fifteen hours of reaction gave a small yield of α,α -difluoro- β -hydroxypropionic acid, presumably via 1,1,2,2-tetrafluoro-1,3-propanediol as an intermediate. The preparation was duplicated by McBee, Marzluff, and Pierce (99).

Formaldehyde and Unsaturated Alcohols:

Erythrol, $\text{CH}_2=\text{CHCHOHCH}_2\text{OH}$, reacting as its acetate, with formaldehyde in acetic acid and sulfuric acid gives chiefly 3,4-diacetoxytetrahydro-2H-pyran (122).

Formaldehyde and Unsaturated Ethers:

Monoethers of unsaturated dihydric alcohols have been synthesized by Arundale and Mikeska (12) by treating tertiary alkenyl ethers, such as dimethallyl ethyl ether, with formaldehyde. Catalysts for this reaction are metallic halides or metallic salts of halogenated organic acids. Alkoxy-m-dioxanes are also claimed by them (14); these result from the reaction of one mole of dimethallyl ethyl ether with two moles of a saturated aldehyde in the presence of a dilute acid-reacting catalyst.

Formaldehyde and Unsaturated Acids:

Pigulevskii and Tatarskaya (131), who appear to be the only workers to have studied this particular condensation type, caused formaldehyde to react with oleic acid at -10° and up in

essure to give 5,6-dihydro-2H-pyran (I), Gresham and Steadman 9) could not effect this reaction at 185° in an autoclave. They did, however, accomplish the corresponding synthesis of 4-dimethyl-5,6-dihydro-2H-pyran from 2-methyl-1,3-pentadiene, which is evidently more reactive.

The situation is altered when an acid catalyst is used, no fewer than five investigators (15, 35, 60, 87, 111, 121) having recently studied the Prins reaction of formaldehyde and 1,3-pentadiene. Both 1,2 and 1,4 addition of formaldehyde occurs, the former to yield 4-vinyl-1,3-dioxane (II) (35, 60, 87); the unsubstantiated claim that this product is 5-vinyl-1,3-dioxane (4) is denied both by orientation rules of the Prins reaction and the reactivity of the compound at its boiling point toward metallic sodium (35, 93). The 1,4 addition results in formation of I (14, 15, 111). It would be expected that both I and II, being olefinic, would add further formaldehyde:

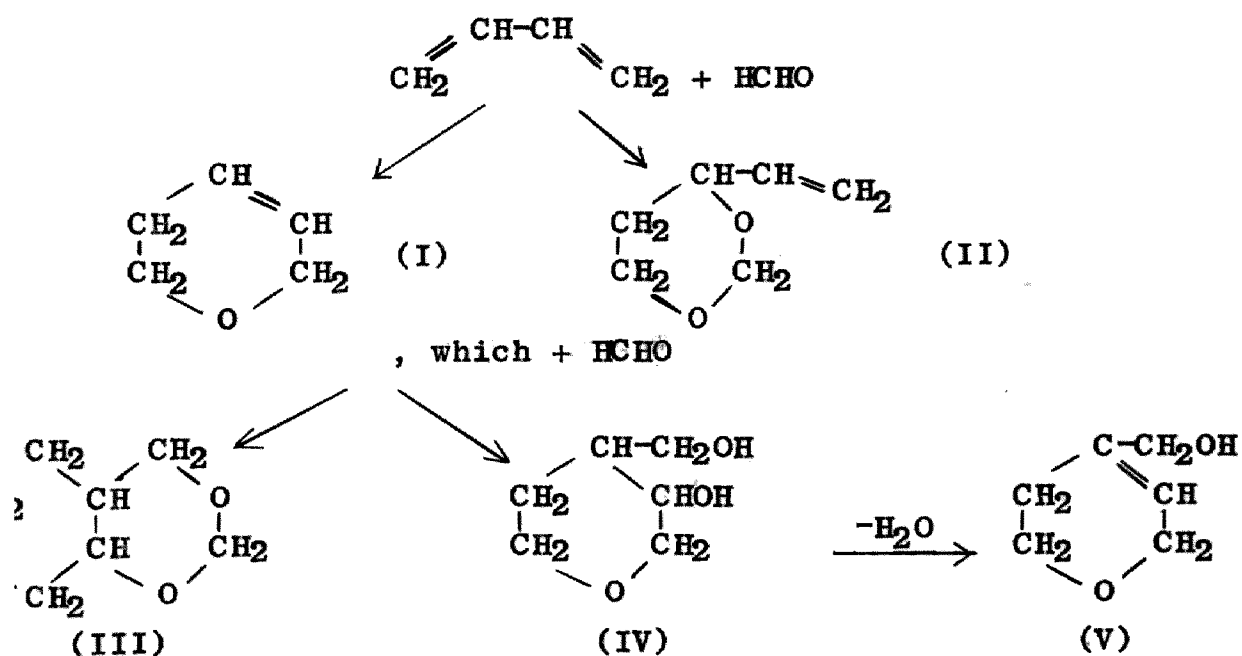

Compound III, hexahydro-2H-pyrano-(3,4-d)-m-dioxin, has in fact been obtained repeatedly (15, 35, 60, 111, 121). Gresham and Grigsby (60) obtained IV, 3-hydroxy-4-methylol tetrahydro-2H-pyran, by saponification of the acetate (121) originally formed; Nelson (35, 111) obtained it in only an impure state by hydrolysis of its formal, III. Nelson also obtained an impure unsaturated alcohol believed to be V, the 4-methylol derivative of I, obtained by Olsen as the acetate (121). However, the compound Kohn (87) believed to be 4,4'-bi-1,3-dioxane resulting from addition of more formaldehyde to II was proved by elementary analysis and otherwise to be in reality III (35, 71). Evidently II as such does not react appreciably with formaldehyde, but it does undergo conversion to III, by way of dissociation (87). Nelson (35, 111) converted II by oxidation into 4-(1,2-dihydroxyethyl)-1,3-dioxane and by bromination into 4-(1,2-dibromoethyl)-1,3-dioxane.

In closely related work, Williams and Ballard (174) claim the formation of dihydropyrans when aldehydes or acetals are condensed with unsaturated alcohols such as $\text{CH}_2=\text{C}(\text{CH}_3)\text{CH}_2\text{CHOHCH}_3$ in the presence of an acid catalyst.

Although many furan derivatives are known to form complex decomposition products with acids, Dinelli and Marini (36) found that compounds containing carbethoxy or nitro groups or the like are relatively stable to acids and react with formaldehyde under Prins conditions to form rather complex products. Thus, ethyl furoate and formaldehyde in the presence of an acid catalyst were found to form 5,5'-dicarbethoxydifurylmethane (VI).

This latter compound is most likely formed from a Prins condensation of formaldehyde with ethyl furoate to give initially the intermediate compound, 2-hydroxymethyl-5-carbethoxyfuran, which then condenses further with another ethyl furoate molecule to form (VI) through intermolecular dehydration. In a later publication these same authors (37) discussed the results of reacting an excess of formaldehyde with ethyl furoate and other furan derivatives under Prins reaction conditions. The reactants were largely converted to resinous material, but they did succeed in isolating one complex product which they identified as "an internal ether (VIII) of 5,5'-dicarbethoxydihydroxymethyldifurylmethane" (VII). It will be noted that VII formed by hydroxymethylation of VI can be converted to VIII by way of an intramolecular dehydration step this time. The reaction scheme described above is essentially as follows:

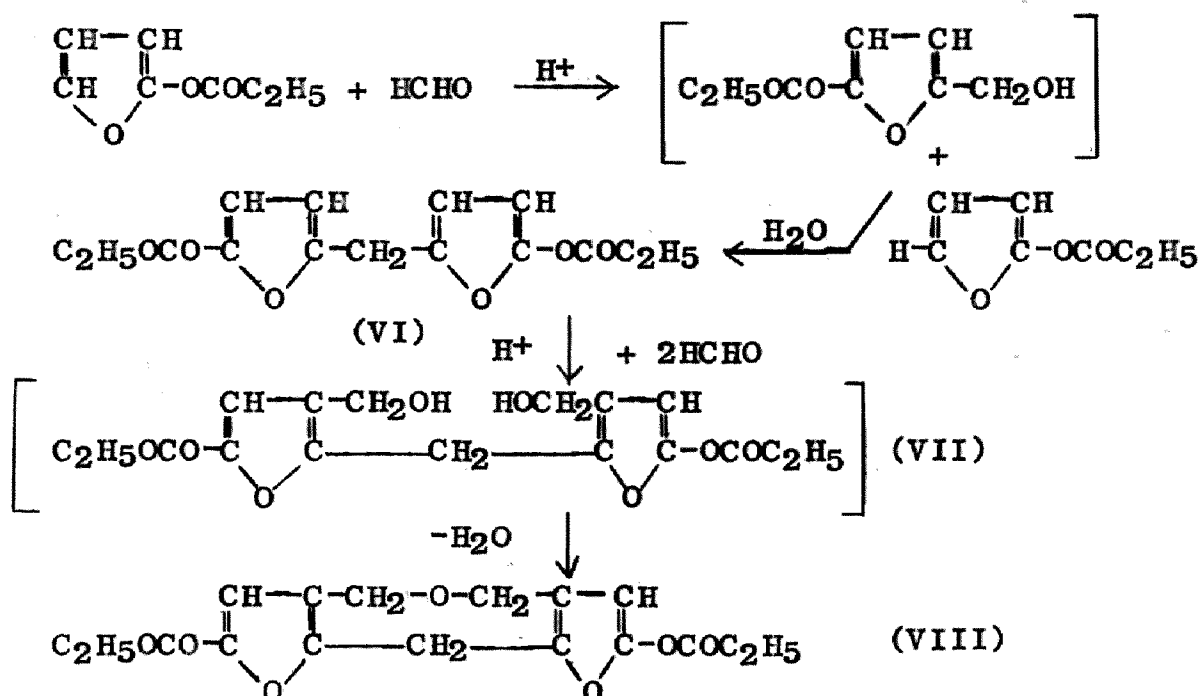

The tendency of the furan derivatives to hydroxymethylate relates their reactivity closely to that of the highly branched-chain olefins which readily hydroxymethylate under Prins conditions.

Whitner (173) claims the use of a product from a Prins-type reaction as a liquid plasticizer for cellulose esters and ethers. The product is derived from formaldehyde and butadiene in glacial acetic acid solvent with a concentrated sulfuric or an aromatic sulfonic acid catalyst. Other dienes such as isoprene, a pentadiene, or a hexadiene may be used.

Other Aldehydes and Olefins:

An expansion of the formaldehyde-olefin reaction in which other aldehydes are included as the addenda has been reported by Emerson (46). Acetaldehyde, propionaldehyde, n-butyraldehyde and isobutyraldehyde were condensed successfully with styrene in glacial acetic acid containing concentrated sulfuric acid. The main products were m-dioxanes and acetates of 1,3-glycols. Acetaldehyde yielded diacetates while other aldehydes gave only monoacetates. All aldehydes except n-butyraldehyde produced m-dioxanes.

More specialized and less studied is the acid-catalyzed addition of simple aldehydes to vinyl ethers (30). This is reported to give a dimeric resinous adduct hydrolyzable in an acid medium to an unsaturated aldehyde:

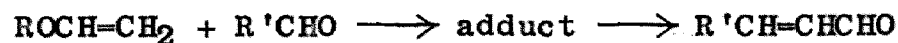

The adduct was not further studied; it would appear likely to contain an 8-membered ring.

The addition of acrolein and other such unsaturated aldehydes to vinyl ethers (160) is essentially an extension of the Diels-Alder reaction and will not be reviewed here.

The only case of an intramolecular Prins reaction is cited by Price and Dickman (134). The unsaturated aldehyde citral in acid undergoes cyclization to an alcohol in which the characteristic 1,3-diol structure is recognizable.

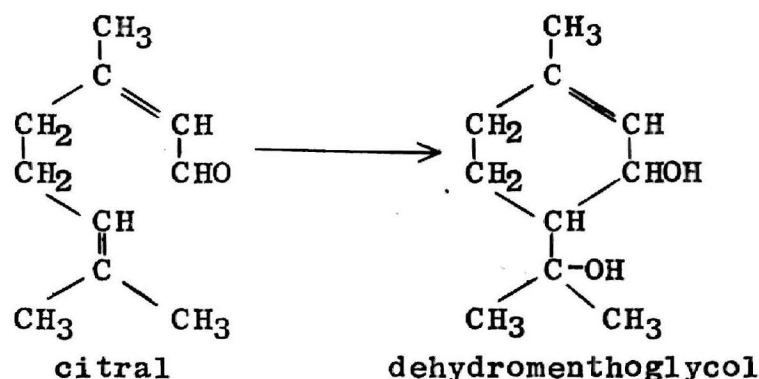

Alpha-Chloro Ethers and Olefins:

A new variation of the Prins type of reaction appeared about 1935 when Scott (154) added monochloromethyl ether to such olefins as propylene:

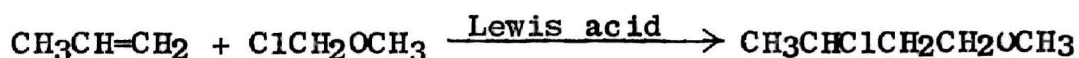

As indicated in the equation, Lewis acids promote the reaction; in this particular work bismuth chloride, tin tetrachloride, zinc chloride and related catalysts were used.

The same experimental conclusions of Scott were obtained independently by Straus and Thiel (169) in 1936. Alpha-

substituted chloro-ethers were found to add to double bonds by means of various acid catalysts or no catalyst at all. Using such catalysts as mercuric chloride, zinc chloride, stannic chloride, and antimony pentachloride, they added chloro-ethers such as methyl chloromethyl ether and phenyl α -chloroethyl ether to both olefins and diolefins. Styrene, cyclohexene, isobutylene, isoamylene, 1,3-butadiene, 1,3-cyclohexadiene, and cyclopentadiene were the olefins used in the investigation. Phenyl α -chloroethyl ether and liquid butadiene condensed in the presence of mercuric chloride gave a 65% yield of 1-phenyl-1-methoxy-5-chloro-3-pentene. With methyl chloromethyl ether and butadiene, using zinc chloride catalyst, they obtained a 70% yield of two isomeric 1-methoxychloropentenes.

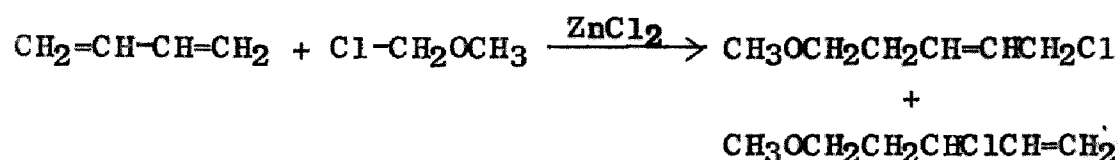

The isomeric products proved to be very similar in structure to two new compounds synthesized in the present work, and aided in the establishment of their structures by analogy. Note of these two compounds will be made subsequently.

Straus (170) in a later patent expanded the reaction to include other halides. In general, he claimed that compounds of the formula $\text{RCH}(\text{OR}')\text{X}$, where R is H or an alkyl, aryl, or aralkyl group, R' is an alkyl group, and X is halogen, undergo an additive reaction in which higher-molecular-weight chloro-ethers are produced. Another patent claim (171) extended the

reaction to include combination of the starting materials that react to form the particular chloro-ether desired and thence addition to a double bond, all in one operation. That is:

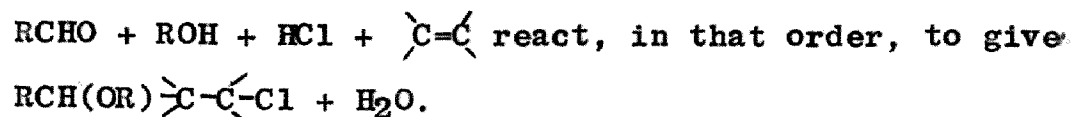

It is noteworthy that addition of chloromethyl ether to vinylacetylene (44) occurs wholly at the triple bond, producing 5-methoxy-3-chloro-1,3-pentadiene, which was evidently not observed to react further.

Nenitzescu and Przemetzky (112) investigated many reactions catalyzed by aluminum chloride while seeking to find a route for synthesizing 8-methyl-1-hydrindanone. They catalyzed the addition of methyl chloromethyl ether to olefins by aluminum chloride and noted that it was similar to that described in a British patent (43) in which an olefin is treated with formaldehyde and hydrochloric acid in the presence of zinc chloride. The addition is the same as Straus had found.

Pudovik (143, 144) recently repeated some of Straus' work, improving the procedure and generally investigating the properties of the products more thoroughly and precisely. They caused chloromethyl ether and other alpha-halo ethers to react with butadiene to get the previously mentioned isomeric compounds along with higher-boiling products. These compounds were subjected to rearrangements of the allylic-ether type which were studied considerably (143, 145, 146).

Emerson, Deebel, and Longley (47) found that the addition of twelve alpha-chloro ethers to butadiene using zinc chloride

catalyst gave 61-86% yields of mixtures of 5-alkoxy-3-chloro-1-alkenes and 5-alkoxy-1-chloro-2-alkenes. In addition these compounds were subjected to hydrogenation and exchange of chlorine for carboxyl, amino, and isothiocyano radicals.

Amino ethers and diamines were prepared by Amundsen and Brill (3) by ammonolysis of the products of the condensation of chloromethyl ethers with butadiene. They followed the procedures of Straus and Thiel.

In further extension of Straus' work, Martin (97) used titanium tetrachloride catalyst, an olefin such as isobutylene, and a chloroether of the type ClCH_2OR to form higher halogenated ethers.

Ketene was condensed with alpha-halogenated ethers in the presence of acid catalysts by Staudinger and Tuerck (39). The product, an alkoxypropionyl halide, is the result of addition of such ethers to the carbon-carbon double bond with the negative chlorine linking as expected to the "carbonyl" carbon. Diketene was also utilized in the above reaction. Lewis acids such as zinc chloride and aluminum chloride catalyze the reaction.

Allard (1, 2) attempted an acid-catalyzed reaction of chloromethyl ether with terpenes in the hope of getting either chloromethylation or additive condensation with the chloroether, but obtained only terpene-hydrogen chloride and terpene-acetic acid addition products and rearranged terpenes.

It may be noted here that Cass (26) has demonstrated that a halogenated alkoxy alkene, 1-methoxy-4-chloro-2-butene, has

good fungicidal properties. This property may well appertain to the products discussed above though Cass's compound was synthesized from 1,4-dichloro-2-butene and alcoholic alkali.

Alpha-Chloro Esters and Olefins:

Alpha-chloromethyl acetate is reported to add into various olefins using acid catalysts (113). To date this seems to be the only reference in which this additional new variation of the Prins reaction has been effected with any success. The following reactions illustrate the synthesis that was effected:

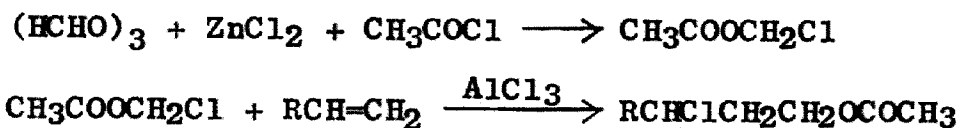

Kharasch and co-workers (86) report attempting to add chloromethyl acetate and polychloromethyl acetates to olefins under acid conditions. They recounted that chloromethyl acetate gives a poor yield of the addition product with 1-octene. Generally the addition of chloromethyl acetates to olefins has been under the influence of basic or peroxide catalysts (43, 69). Descriptions of products derived from such reactions are quite obscurely drawn and probably irrelevant here.

Acetals and Olefins:

This further variation in the Prins-type reaction has gained considerable interest in recent years and the literature to date has enumerated examples which give a greater understanding of the reaction type. The addition of acetals and ketals to ketenes to yield alkoxy-substituted esters has been reported by

Brooks (22, 23). The reaction of these acetals such as methylal requires a strong acid catalyst. Sulfuric acid was considered among the poorer catalysts as regards yield and boron trifluoride was considered the best. For example, methylal, ketene, and boron trifluoride gave a 73% yield of methyl β -methoxypropionate.

Gresham (65) claims the similar formation of ether esters from the condensation of ketenes with ortho esters under the influence of acid catalysts.

In the course of extending a study of the chemistry of vinyl ethers Hoaglin and Hirsh (74, 75) caused reaction of various acetals and α, β -unsaturated ethers in the presence of acid catalysts. These authors showed that prior work of this sort (114) was in serious error. That acetals add to α, β -unsaturated ethers as in a Prins reaction was determined by means of two syntheses; the first involved the condensation of diethyl butyral and vinyl ethyl ether, while the second entailed the addition of diethyl acetal to 1-butenyl ethyl ether. The product of the first reaction, 1,1,3-triethoxyhexane IX, was simultaneously hydrolyzed and deethanolated with a mineral acid to give 2-hexenal X, a known compound.

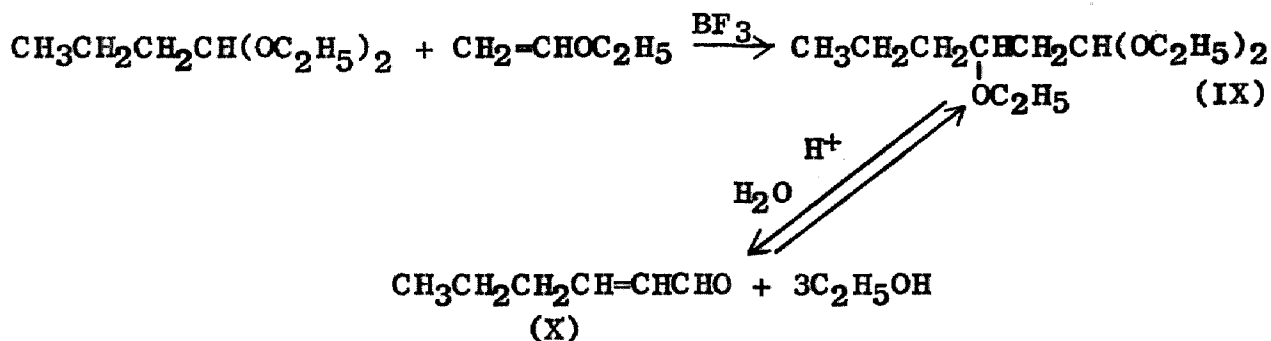

The product of the second reaction, 1,1,3-triethoxy-2-ethylbutane XI, was similarly treated giving 2-ethyl-2-butenal XII, also a known compound.

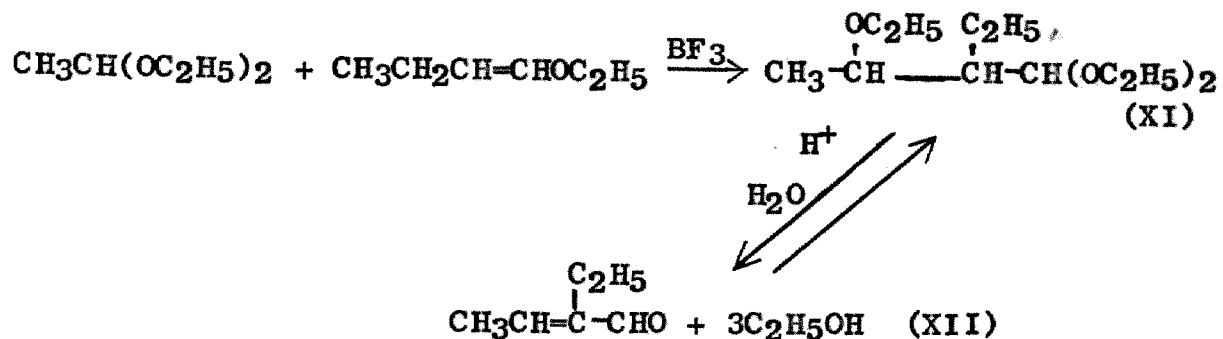

Further proof of structure was given through infrared-spectrometer studies of the products

The same reaction was patented by Copenhaver (31) for α,β -unsaturated cyclic ethers; thus 3,4-dihydro-2H-pyran and dimethyl acetal gave the expected adduct.

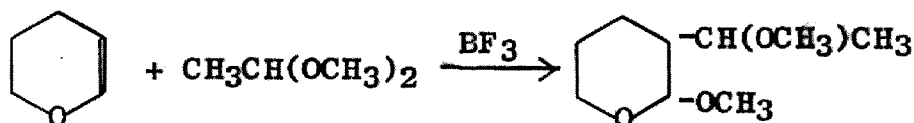

While this dissertation was being written, a French publication (129) appeared describing work by Paul and Tchelitcheff on the acid-catalyzed condensation of acetals with olefins. These authors used only diethyl acetal and higher acetals in their work. They mentioned a previous publication (128) in which they had condensed acetals with dihydropyrans, 2,3-dihydrofuran, and also aliphatic vinyl ethers. In the new work, reaction of diethyl acetal with isobutylene at 90° under the catalytic influence of boron trifluoride etherate gave four products. The products consisted not only of the 1:1 addition

product, which they believed to be 2,4-diethoxy-2-methylpentane (XIII), but the product of its deethanolation, 2-methyl-4-ethoxy-1-pentene (XIV); a product of renewed addition of acetal to XIV followed by loss of ethanol, 2,6-diethoxy-4-methyleneheptane (XV); and tert-butyl ethyl ether.

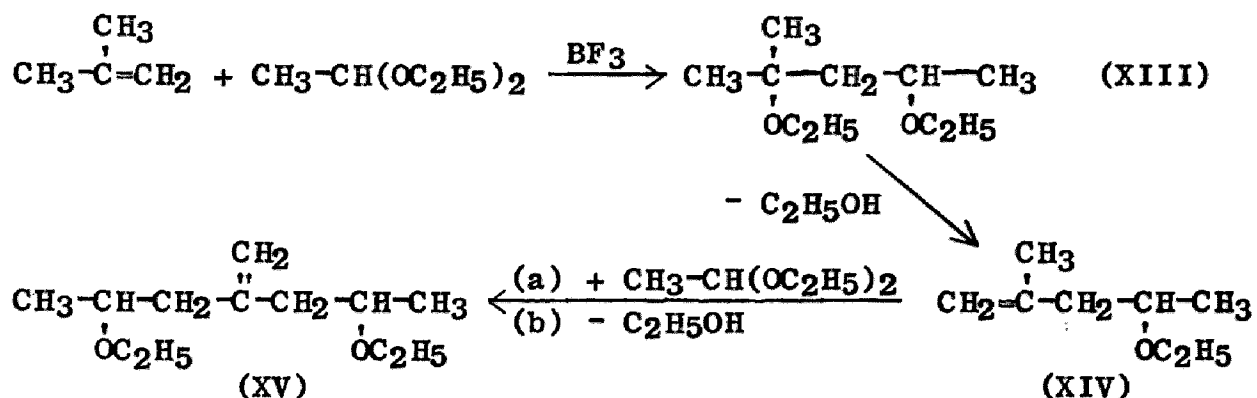

This same condensation reaction between diethyl acetal and isobutylene has been effected in our laboratories and significantly different results were obtained which will be discussed in the experimental section of the thesis.

In our own laboratories the present author (72) has extended the Prins reaction to include the addition of the acetal, methylal, to 1,3-butadiene with concentrated sulfuric acid as the catalyst. Four products were isolated and characterized: 3,5-dimethoxy-1-pentene (XVI), 1,5-dimethoxy-2-pentene (XVII), 3-methoxy-4-methoxymethyltetrahydropyran (XVIII), and 1,2,5-trimethoxy-3-methoxymethylpentane (XIX). For structure (XVIII) another isomer might be produced, 3-methoxymethyl-4-methoxytetrahydropyran, but the orientation rule given previously favors formation of the first compound. Similarly structure

(XIX) might be thought to be the isomer 1,3,4,6-tetramethoxyhexane (XX).

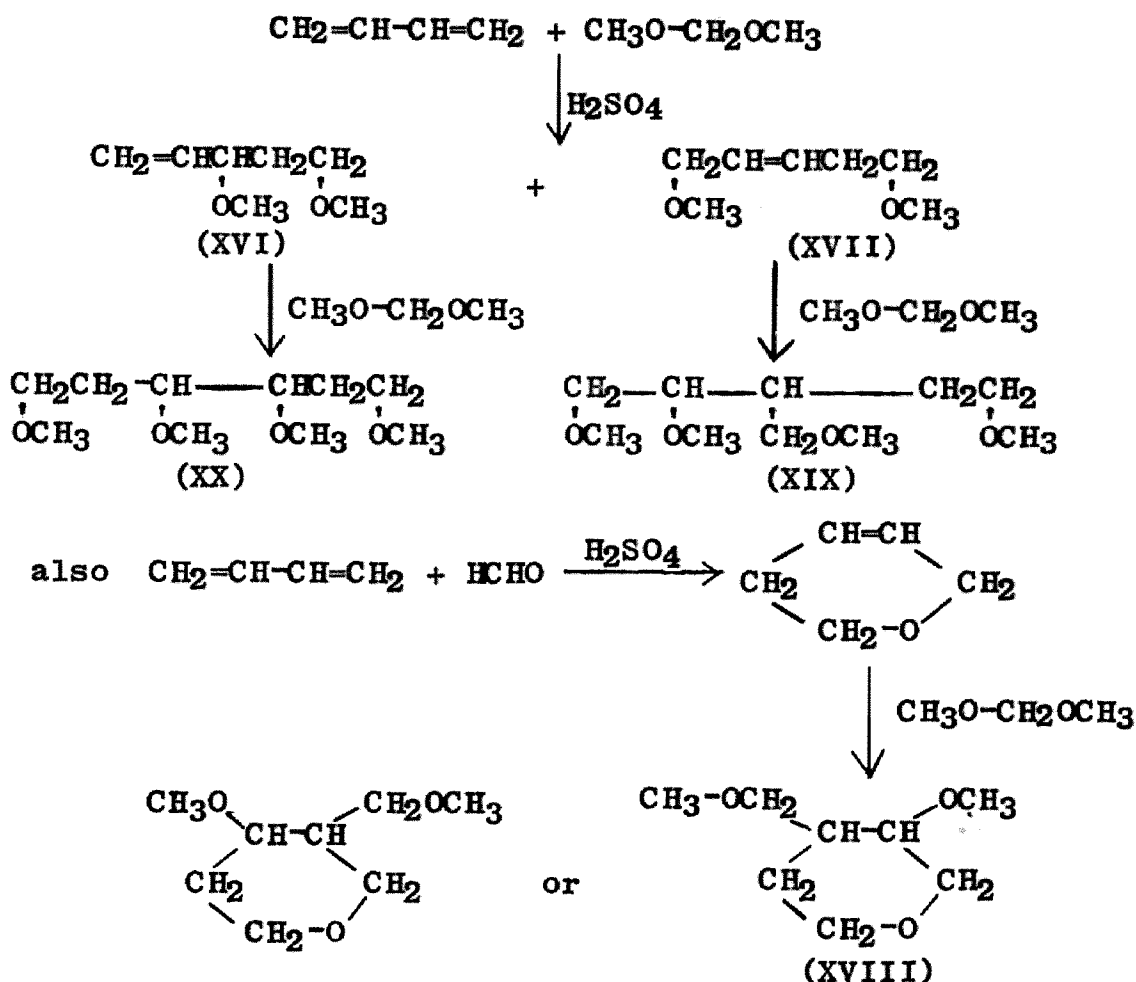

Evidence has been found since this particular work was terminated at the Master's thesis to support the presence of a fifth compound which is believed to be 1,3,4,6-tetramethoxyhexane. The evidence will be discussed in the experimental portion of this dissertation. It is interesting to note that compound XVII, has been synthesized by Pudovik by a different method (146) and his physical constants check excellently with those found by the present author.

A thorough literature search for further additions of methylal to olefins in the presence of acid catalysts has indicated the novelty of the reaction thus far. The claim that methylal may be condensed with olefins to form cyclic formals and thence 1,3-glycols is made in a patent (5) mentioned previously. The synthesis can be either acid-catalyzed or not, but must be in the presence of some water so that the methylal can yield formaldehyde to condense with an olefin to yield a cyclic formal; this formal may then be converted to the 1,3-glycol by reaction with methanol in the presence of a dilute aqueous acid catalyst, regenerating methylal as a side product (6, 62, 95). Hence much is open to investigation on the addition of methylal to olefins under anhydrous Prins conditions.

II. PROPOSED MECHANISMS

Although the Prins reaction is well established historically and has been investigated carefully by several workers with the intent of elucidating the reaction mechanism, the resulting theories have been in conflict and at most seem only to bring us closer to the correct answer. The review to follow presents the developments in the theory of the Prins reaction which have been published. It is hoped that this theory supplemented by our own investigation will approximate the truth.

While Prins was developing the reaction, and as late as 1932 (142), he believed that he obtained a four-membered cyclic ether by the reaction of formaldehyde with styrene. This led him to propose the following mechanism:

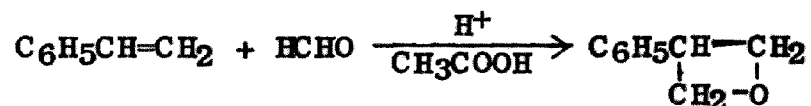

The ring may then open to absorb some other molecule:

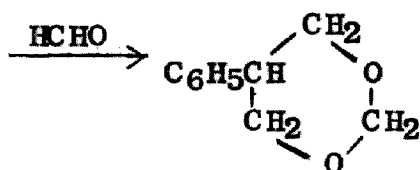
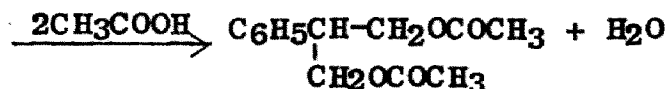
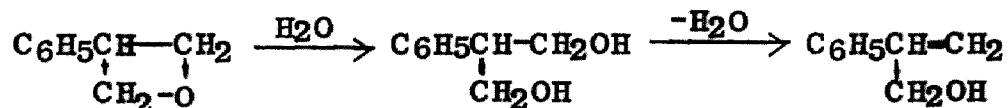

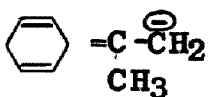
In a recently published work, Baker (18) chose two specific olefins, ethylene and α -methylstyrene, that would serve to illustrate and prove the α -methylene activity doubted by Price. He supposed that the α -methylene hydrogen atom in the propylene molecule was activated through ordinary hyperconjugation: $\text{H} \text{---} \overset{\curvearrowright}{\text{C}} \text{---} \overset{\curvearrowleft}{\text{C}}$. In ethylene such hyperconjugation is structurally impossible, while in α -methylstyrene it would be greatly diminished owing to the relative importance of structures of the type $+$  $=\overset{\ominus}{\text{C}}\text{---}\overset{\oplus}{\text{C}}\text{H}_2$ in the resonance hybrid of the compound. On the other hand, polarization of the olefinic double bond, $\overset{\text{Ph}}{\text{C}}=\overset{\text{Me}}{\text{C}}\text{H}_2$, in the aromatic olefin should be enhanced, and its activity thus increased. After effecting the reaction, and isolating the products, Baker decided that, as expected, the reactivity of ethylene is much lower than that of propylene, and the only identifiable product from ethylene is that which arises from an acid-catalyzed addition to the double bond. He also concluded that α -methylstyrene exhibits the expected increased reactivity in reactions which involve addition of electrophilic reagents to the double bond, but little or no reactivity of the hyperconjugated or allylic hydrogen atom of the methyl group, since no evidence of its involvement was found.

Of Baker's alternate mechanisms, that involving simple olefinic polarization is believed to predominate if the olefinic structure is such that an acid-catalyzed polarization at the double bond is unopposed by functional-group effects that might

shift the center of polarity outside the carbon-carbon double bond. The structure may be highly symmetrical like ethylene and tend to diminish the existing acid-induced polarity but not cause a shift in its position; or it may be unsymmetrical like α -methylstyrene and enhance this polarity through highly inductomeric functional groups present in the olefin. In Baker's other mechanism the hyperconjugative effect is strong and the acid catalyst, if present, also tends to favor hyperconjugation producing an α -methylene hydrogen atom. Such a structure is ideally of the type $R_2C=CRCH_3$.

Baker (19) in further defense of his α -methylene hydrogen atom theory applied to producing unsaturated alcohols, $R_2C=CRCH_2CH_2OH$, has cited a British patent (164) which describes the synthesis of 3-methyl-3-hexen-1-ol from 2-methyl-2-pentene. Baker's mechanism formulates this synthesis thus: (L represents a Lewis acid).

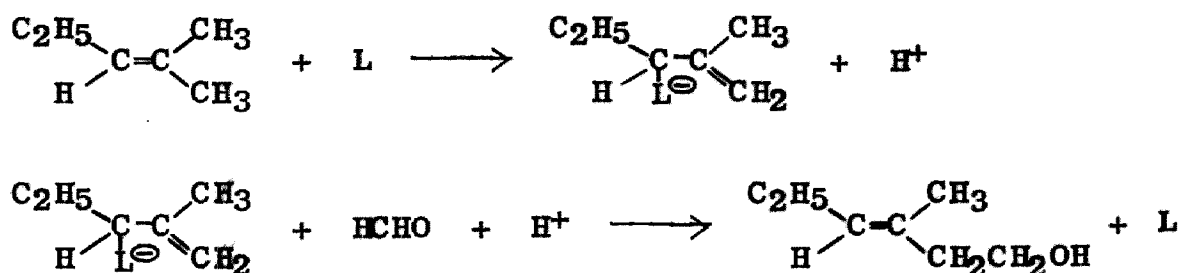

If the above olefin were to react with formaldehyde according to the mechanism postulated by Price, Baker contends that the product would be 2-ethyl-3-methyl-2-buten-1-ol rather than the product actually isolated. Presumably the hypothetical product would form by the following route:

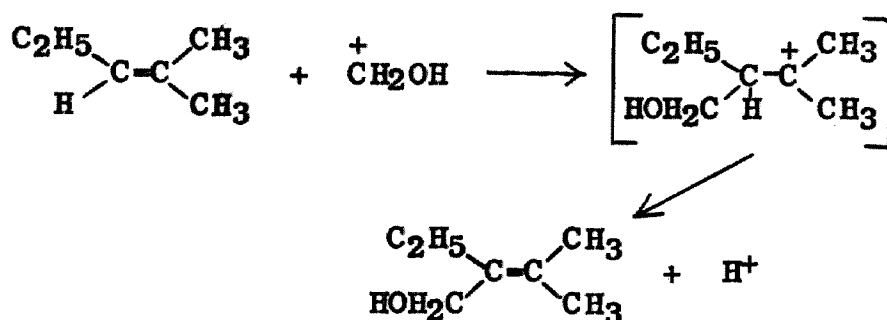

Baker points out that the Price mechanism gives the correct structure for the reaction product only when the olefin is of the type $\text{CH}_3\text{CR}=\text{CH}_2$. He reasons that in such cases it is virtually impossible to differentiate structurally between a $-\text{CH}_2$ group formed from an initial $-\text{CH}_3$ group and a $-\text{CH}_2$ group of the parent olefin. Contrary to Baker's belief the question of differentiation could be settled easily with modern tracer techniques simply by use of a tagged methyl group, C^{14}H_3 . This could ultimately prove or disprove the theories of Baker and Price and contribute greatly to a final answer on the correct Prins reaction mechanism. The essential feature of Baker's mechanism challenged by Price is that addition of a Lewis acid can actually cause separation of a proton (which is already activated by hyperconjugation) in the presence of a proton acceptor.

Rather coincidentally the choice of mechanisms for the acid-catalyzed addition of acetals to α,β -unsaturated ethers has resolved into types somewhat parallel in concept to the ones described above. Mueller-Cunradi and Pieroh (109) initiated acetal addition to ethers of vinyl alcohol and from the products isolated postulated the splitting of an α -hydrogen atom

EXPERIMENTAL

Although this investigation is concerned mainly with the condensation of methylal and other acetals with monoolefins, a few supplementary experiments concerning the methylal-butadiene work previously reported (72) will be discussed herein. Our choice of olefins to be tested, in general, represents an attempt to vary as widely as possible the basic olefinic activity so that some insight might be secured concerning the effect of olefin structure on this type of reaction. Actually only the commonest and cheapest olefins were tested: propylene, isobutylene, styrene, cyclohexene, and α -pinene. Ethylene was not tried because it was considered unlikely to react well except at higher pressures (>75 lb./sq.in.) than we could easily apply. Acetylene was found not to react.

Methylal and butadiene. Four new products of this reaction were isolated and reported in full in a previous thesis (72). The products were: 3,5-dimethoxy-1-pentene XVI, 1,5-dimethoxy-2-pentene XVII, 3-methoxy-4-methoxymethyltetrahydro-2H-pyran XVIII, and 1,2,5-trimethoxy-3-methoxymethylpentane XIX. It was considered likely that an isomer of XIX, i.e., 1,3,4,6-tetramethoxyhexane XX was also produced but that it had not been isolated from the high-boiling residues that were consistently encountered in the workup of the crude

reaction products. Through consolidation and precise rectification of this residual material at low pressures, we were able to isolate a compound that convincingly matched the theoretical values for (XX). The compound had the following properties:

Table I

Properties of New Methylal-Butadiene Reaction Product

	<u>Experimental</u>	<u>Calc. for C₁₀H₂₂O₄</u>
Carbon content, %	57.97	58.25
Hydrogen content	10.18	10.67
Molar refraction, ml.	53.2	54.95
Boiling point, °C at 1 mm.	79-80	
Refractive index, n_D^{22}	1.4510	
Density at 22°, g./ml.	1.047	

Except for the uncertainty of orientation, the structure postulated earlier in this paragraph or an isomer thereof is virtually certain in view of the reactants and the experimental evidence cited in Table I.

Products (XVI) and (XVII) both dimethoxypentenes, were hydrogenated as an additional check on previous work and to derive new products for study. Thus a 21.7-g. sample of 3,5-dimethoxy-1-pentene was hydrogenated with Raney nickel and hydrogen in a Parr low-pressure hydrogenator at 25-50 lb./sq.in. and room temperature. A yield of 19.6 g. (89%) of 1,3-dimethoxypentane was obtained. Similarly 16.7 g. (76%) of 1,5-dimethoxypentane was obtained. A check of the literature demonstrates

the novelty of 1,3-dimethoxypentane but Beilstein lists properties for 1,5-dimethoxypentane which when compared with those we obtained furnish convincing proof of the identity of both our hydrogenated product and its precursor. Obviously this is also strong proof of the correctness of the postulated orientation pattern in the condensation reaction thus far. Another reference was found (146) which describes the formation of 1,5-dimethoxy-2-pentene from 1-methoxy-5-chloro-2-pentene and alcoholic KOH. The compound (at least in the abstract in Chemical Abstracts) is misnamed 1,5-dimethoxy-3-pentene, but is undoubtedly the same compound as we dealt with as is shown by method of preparation, refractive index (1.4259 their value, 1.4251 ours), and density (0.885 their value, 0.885 ours). The literature boiling point was 52° at 10 mm., which is compatible with ours of 164° at 745 mm. Table II is a compilation of properties found for the two hydrogenated dimethoxypentenes:

Table II
Properties of Hydrogenated Dimethoxypentenes

	C, %	H, %	n_D^{22}	d_4^{22} g./ml.	M.R. ml.
Obs. for cut with b.p. 140.5-41° at 745 mm.	63.2	12.1	1.4025	0.853	37.2
Calc. for 1,3-di- methoxypentane	63.6	12.1			37.8
Obs. for cut with b.p. 157-157.5° at 745 mm	63.3	12.3	1.4060	0.854	37.4
Calc. for 1,5-di- methoxypentane	63.6	12.1			37.8

For 1,5-dimethoxypentane, formed from 1,5-dibromopentane and sodium methoxide, Dionneau (38) lists the following properties: b.p. 156-7° at 760 mm., n_D^{15} 1.4094, d_4^{15} 0.8616.

Methylal and propylene. The boron trifluoride-catalyzed reaction between methylal and propylene was conducted in the following manner: 43 g. of gaseous catalyst was bubbled into 150 ml. of methylal with cooling. With sufficient cooling, usually to -20°, a minimum of darkening of the methylal occurred as the catalyst was added. The same darkening was noted even with this cooling if the gas was added too rapidly. This mixture was placed in the pressure bottle of a Parr low-pressure hydrogenation apparatus which had been previously charged with propylene gas to 55 lb./sq.in. initial pressure. After three hours at 30-55 lb./sq.in., 28 g. of propylene had been added to the methylal and the reaction was halted and the mixture allowed to remain overnight under its own pressure. A definite heat of reaction was initially perceptible, indicating a much more rapid reaction than we had supposed. Hence it was believed likely that better yields might be obtained if the neutralization of the acid catalyst were effected immediately after the desired amount of olefin had been added, so as to minimize the polymerization of propylene.

The propylene-methylal reaction mixture was subsequently neutralized in one of two ways: either by adding the mixture to a cooled solution of sodium hydroxide (or potassium carbonate) exactly equivalent or in slight excess to the original amount of

acid catalyst present; or, alternatively, by bubbling anhydrous ammonia through the mixture to separate the catalyst as the insoluble $\text{BF}_3:\text{NH}_3$ complex. The latter neutralization process has the advantage of maintaining anhydrous conditions throughout the workup so that the resulting mixture may be distilled directly without preliminary drying. However, the process of neutralization is actually a slow one since a bubbling tube must be used rather than a gas disperser to avoid persistent and rapid clogging by the complex. Apparently the ammonia neutralization would be entirely superior to all others if the gas could be introduced into an efficiently stirred system under pressure. Since it was determined that the aqueous alkaline treatment was overall more effective in purification of our products, it was chosen as standard procedure in all subsequent reactions.

After the batch was neutralized it was immediately steam-distilled to effect separation of methylal and the greater portion of the products from the aqueous salt solution. A minor amount of insoluble oil remaining in the aqueous phase was extracted for possible further treatment, but was discarded later as devoid of any product in ordinary boiling range. The steam distillate was thoroughly dried over anhydrous potassium carbonate. After the unreacted methylal had been stripped off, the products were distilled through a Todd semimicro column to yield one main product, boiling point 120° at 745 mm., and a smaller but seemingly significant plateau on the boiling-point curve near 117.5° at 745 mm. This latter material was never purified enough to permit identification, the yield during any

one synthesis being extremely low. However, the trend of the refractive index, which rose to a maximum at 117.5° and then decreased again for immediately higher-boiling fractions, is considered significant in view of later proof of variable orientation in addition of methylal and diethyl acetal into the olefin isobutylene.

Physical and chemical tests were run on the main component isolated in pursuance of proof of structure. In view of the nature of previous Prins-type reaction products from methylal and 1,3-butadiene two main structures could be expected from the condensation of methylal and propylene. One might result from the addition of one mole of methylal, to give either or both of two compounds (and the evidence suggests both) according to the following equations:

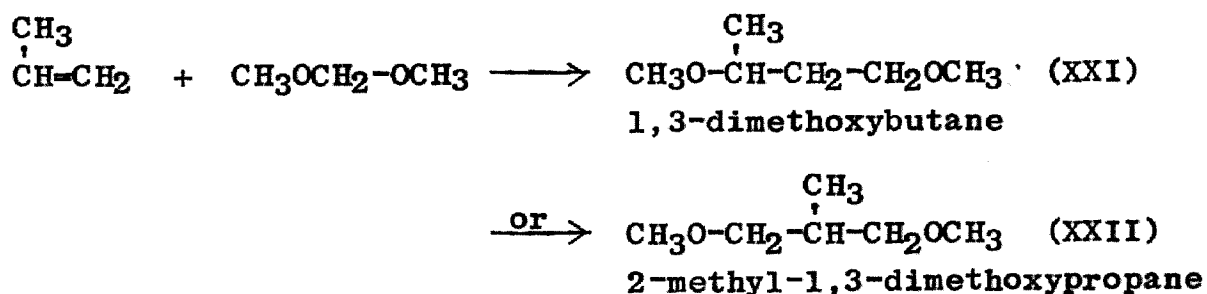

The other might come from addition of a hypothetical formaldehyde dimer, formed somehow from methylal, into the propylene double bond as follows:

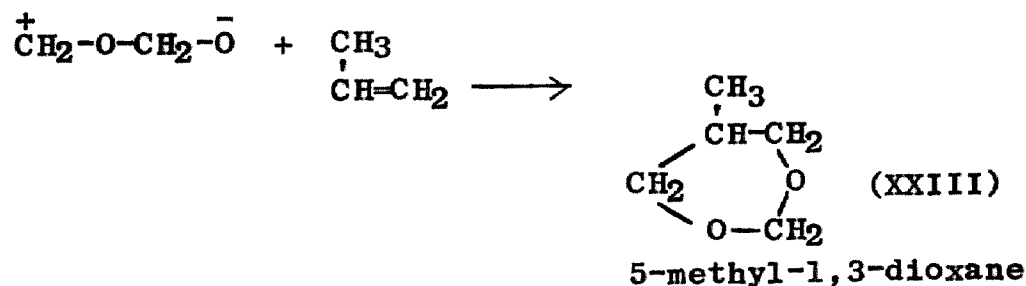

In the distillation data cited above it was noted that a plateau appeared at about 117.5° and then another more extensive one at 120°. Compound XXII would be lower-boiling than XXI, but not by much, and also XXII would be predicted to have the higher refractive index, since the index of refraction generally increases as a methyl group is shifted from the end of a chain toward its center. This is precisely the evidence of the distillation data. Thus it would appear that a small amount of XXII was formed and a much greater amount of XXI. Structure XXIII could be expected to fall in this same range of boiling point and refractive index. The presence of traces of carbonyl compounds of substances hydrolyzable thereto throughout this boiling range suggests that XXIII is indeed present. However, the following physical data support strongly the belief in the predominance of C₆H₁₄O₂ (XXI or XXII) rather than C₅H₁₀O₂ (XXIII).

Table III

Properties of the Principal Methylal-Propylene Product

	C, %	H, %	M.W.	n_D^{25}	d_4^{25} g./ml.	M.R. ml.
Obs. for cut with b.p. 120° at 754 mm.	60.7	11.7	120	1.3904	0.842	33.2
Calc. for 1,3-di- methoxybutane or an isomer	61.0	11.9	118			33.4
Calc. for C ₅ H ₁₀ O ₂ (XIX)	58.8	9.8	102			26.4

Further evidence was needed to permit certainty in assigning the structure 1,3-dimethoxybutane to the compound with boiling point 120°. It was considered likely that synthesis of this compound by methylation of 1,3-butanediol could be accomplished easily and that coincidence of properties would prove beyond any doubt its structural identity. The methylation was accomplished in the following manner: 1,3-butanediol was initially treated with metallic sodium under reflux until the entire mixture became a thick slurry. To this mixture small portions of freshly washed dimethyl sulfate were cautiously added with agitation until the mixture was acidic to indicator paper. The mixture remained slushy throughout these operations. An approximately 50% solution of potassium hydroxide was next added to this mixture to assure methylation of both hydroxy groups in the butanediol molecule. Additional quantities of dimethyl sulfate were then added until further tests of acidity were positive. The mixture was made basic once more and steam-distilled. The steam distillate was treated with potassium carbonate to salt out any oil present in the aqueous phase. This oil was subsequently dried over anhydrous potassium carbonate, and fractionated through the Todd semimicro distillation column. The oil distilled nearly quantitatively in the range 120-120.5° at 745 mm. A center cut proved to have the following properties: n_D^{22} 1.3916, d_4^{22} 0.8435, M.W. 119. Correlation of these properties with those in the table above indicated beyond any reasonable doubt the identical nature of the two compounds, and completes our proof of structure of 1,3-dimethoxybutane.

Thus, the principal product of the addition of methylal to propylene is that predicted by analogy with other Prins reactions.

Methylal and isobutylene. An attempt was made to effect condensation of these two reagents in much the same way as the methylal-propylene condensation had previously been produced in the Parr low-pressure hydrogenator. The hydrogenator was charged with tank isobutylene to the autogenous pressure of 25 lb./sq.in. (at room temperature). A typical mixture of methylal and boron trifluoride catalyst was shaken with isobutylene at this pressure for twenty-four hours with no particular change in pressure noted that would indicate reaction. The reaction bottle was heated for at least eight hours with an infrared lamp to about 60° under the same conditions with similar negative results.

In spite of this experience, it was found possible to condense methylal and isobutylene under the following conditions: Boron trifluoride, 16 g., was complexed with 300 ml. of methylal in the cold. To this cold (-20°) mixture, 82 g. of liquid isobutylene was added and the composite sealed in a pressure bottle. The bottle was placed in a shatter-proof metal can, allowed to come to room temperature and kept sealed for two days. Inspection of the bottle during the first few hours of reaction revealed that considerable heat was being evolved. After two days the bottle was uncapped cautiously to avoid any loss of product through flash volatilization of any unreacted isobutylene. In this particular case loss in weight due to isobutylene

evaporation was slow and negligible.

Any loss in weight due to evaporation of free isobutylene was noted to permit calculation of the approximate weight of reacted isobutylene. This is obviously not accurate, as it does not allow for unreacted dissolved olefin. The 82 g. mentioned above is this final weight of olefin found. The reaction products were subsequently treated as for the propylene reaction. Distillation of crude material yielded 76 g. of product of b.p. 140-3°, and 16.4 g. of product with b.p. 149-52°.

From experience with the propylene-methylal condensation the most likely paths of reaction of methylal with isobutylene were considered to be the following:

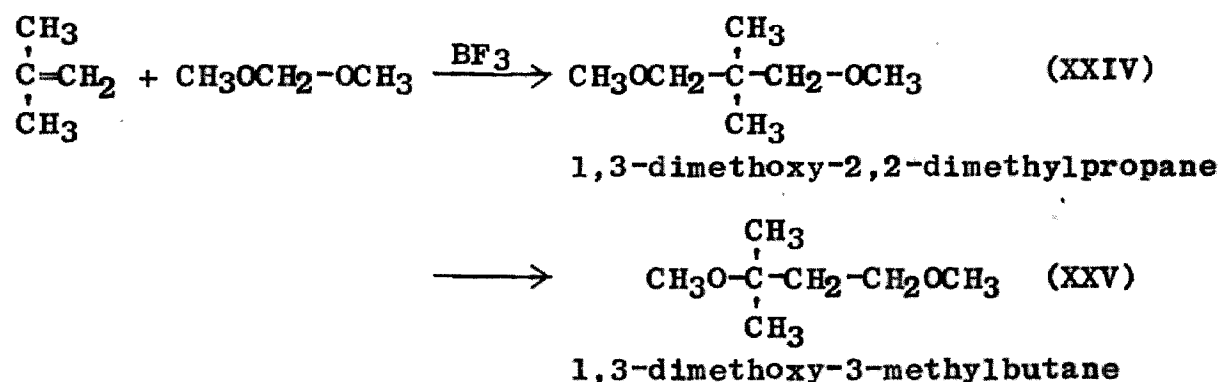

The two fractions isolated displayed physical and chemical properties which demonstrated that both isomeric products had been formed. Table IV shows this similarity.

Table IV
Properties of the Methylal-Isobutylene Products

	C,%	H,%	M.W.	n_D^{27}	d_4^{27} g./ml.	M.R. ml.
Obs. for cut with b.p. 141°	63.5	11.9	-	1.4049	0.858	37.8
Obs. for cut with b.p. 150°	63.3	12.1	129	1.4134	0.889	37.6
Calc. for C ₇ H ₁₆ O ₂	63.6	12.1	132			37.8

The fact that the two products are isomers is shown clearly in this table. It will be noted that the lower-boiling product also has the lower refractive index and density. In the light of current theories (XXIV) should be the lower-boiling owing to its greater structural symmetry and should have a higher refractive index and density than (XXV). This partial contradiction of expectations about physical properties places any theoretical postulation of structure on infirm ground. As previously noted, the principal product of the condensation of methylal and propylene results from a typical Prins-type orientation. That is, the alkoxy group joins the central carbon atom, the more electronegative one, and the alkoxymethyl group joins the terminal carbon atom. Similarly the expected structure for the principal product of the methylal-isobutylene reaction would be (XXV), 1,3-dimethoxy-3-methylbutane. The principal product experimentally was the 141° fraction. Thus, the only anomaly in identifying the 141° fraction as XXV was the low boiling point of XXV. A none-too-closely analogous case was found which nevertheless exhibited this same inversion of boiling point.

When CH₃O groups are equated to CH₃ groups, comparison of data for two analogous heptanes with those for (XXIV) and (XXV) yields striking similarities.

Table V

Comparison of Physical Constants for Isomer Pairs

	b.p., °C	d_4^{20}	n_D^{20}
3,3-dimethylpentane	86	.693	1.3911
2,2-dimethylpentane	<u>79</u>	<u>.674</u>	<u>1.3823</u>
Difference	+7	.019	.0088
Compound (XXIV)	149	.889 ^{27°}	1.4134 ^{27°}
Compound (XXV)	<u>141</u>	<u>.858</u> ^{27°}	<u>1.4046</u> ^{27°}
Difference	+8	.031	.0088

Recently we were privileged to gain access to mass spectrometry as a tool in determining identity of these products. A mass pattern was run on a sample of the 141° product. The results of this run are summarized in Table VI.

Consideration of the physical constants enumerated as well as the mass spectrometer data leads us to conclude that methylal has condensed with isobutylene in the expected way. Thus, the 141°-boiling fraction is most certainly 1,3-dimethoxy-3-methylbutane, and the 149° fraction is 1,3-dimethoxy-2,2-dimethylpropane.

Table VI
Mass Spectrometer Data on Compound XXV

Cleavage No.

m/e	Relative intensity	Fragment	Cleavage by which formed
15	25.90	CH ₃	1,5,7 or 8
29	20.84	CHO	(1 and 3) minus H
31	7.92	OCH ₃	2 or 6
41	18.26	CH ₃ CCH ₂	(4 and 6) minus H
43	31.66	CH ₂ CHO	(1 and 4) minus H
45	79.82	CH ₂ OCH ₃	3
55	8.18	(CH ₃) ₂ CCH	(3 and 6) minus H
59*	12.66	CH ₂ CH ₂ OCH ₃	4
69	8.95	(CH ₃) ₂ CCHCH ₂	(2 and 6) minus H
73*	100.00	(CH ₃) ₂ COCH ₃	4
85	23.93	(CH ₃) ₂ CHCH ₂ O	(1 and 6) minus H, or (2 and 5) minus H
100	4.76	(CH ₃) ₂ CCHCH ₂ OCH ₃	6 minus H or 2 minus H
117	6.36	(CH ₃) ₂ C(OCH ₃)CH ₂ CH ₂ O	1,5,7 or 8
131	0.02	(CH ₃) ₂ C(OCH ₃)CHCH ₂ OCH ₃	minus H
132	>0.01	(CH ₃) ₂ C(OCH ₃)CH ₂ CH ₂ OCH ₃	ionization

* Key mass pattern peaks unique to this particular isomer.

Diethyl acetal and isobutylene. In a limited extension of the methyral condensation with olefins, diethyl acetal was chosen as a representative higher acetal to be condensed with isobutylene as the olefin. A mixture of 110 ml. of diethyl acetal and 16 g. of boron trifluoride catalyst was made up in a pressure bottle cooled in a brine-ice bath. To this cold mixture was added 50 g. of liquid isobutylene by condensation of the gas directly in the pressure bottle. The bottle was sealed and set aside to react at room temperature for two days. The mixture was then recooled and the pressure bottle opened. The contents were allowed to come to room temperature under a reflux condenser. When the solution had reached room temperature a final weight of 41 g. was recorded for isobutylene retained by addition to diethyl acetal. The products were isolated like previous reaction products, the steps being initial neutralization, steam distillation, salting out and extraction of steam-distillable products, and extraction of remaining water-insoluble oils. Rough distillation of all dried products through a three-ball Snyder column gave fractions boiling in the ethanol range and also in the diethyl acetal and paraldehyde ranges. Since Paul and Tchelitcheff (129) reported an olefinic ether boiling in the same range as paraldehyde, we tested particularly to determine whether we had isolated some of the same product or merely paraldehyde as originally thought. Reaction with 2,4-dinitrophenylhydrazine reagent (155) produced a dinitrophenylhydrazone identical with that formed by paraldehyde itself. Tests for unsaturation such

as an olefinic ether would exhibit were also run. Behavior towards bromine and permanganate solutions (155) was identical for a known sample of paraldehyde and the fraction believed to be paraldehyde; neither displayed more than trace reaction within several minutes. Hence, we must conclude that our reaction has produced no significant amount of the unsaturated ether.

Precise distillation of the higher-boiling products was attempted with the Todd semimicro column with little success initially. In fact, later redistillation of products based on preliminary separation of material of high and low refractive index still accomplish only inefficient rectification of some products. Two main products were isolated, but the lower-boiling one showed evidence of containing a minor amount of a complex impurity. The higher-boiling cut distilled stably at 176° under atmospheric pressure and from all the evidence was isolated in reasonably pure state. The lower-boiling product was ultimately distilled in vacuo because there was consistent evidence of breakdown during distillation at normal pressures. In the range $77-87^{\circ}$ at 45 mm. pressure two rather indistinct plateaus occurred: one near 77° displaying a maximum in refractive index and a more extensive flat at 85° .

If the isomers produced by the methylal-isobutylene reaction are represented in the condensation of diethyl acetal and isobutylene, the following reaction would be expected:

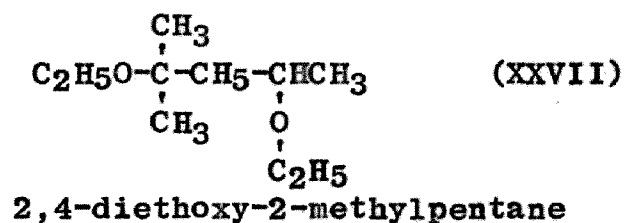
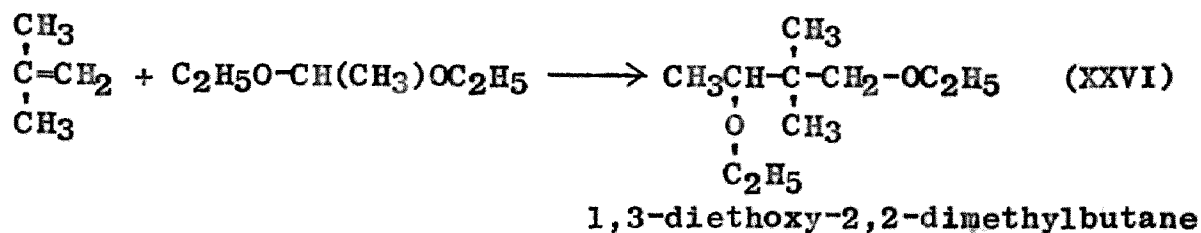

With regular Prins orientation occurring in the addition, compound (XXVII) would be the principal product. Since the higher-boiling cut (at 176°) was the predominant product, it would be expected to have the structure of compound (XXVII). This fraction was isolated in 18% yield (which at best is only semiquantitative owing to difficulties in separating products) while the 85° fraction, believed to be compound (XXVI), was obtained as 14% of the amount expected according to isobutylene reacted. The following physical and chemical data were noted for these two fractions:

Table VII

Properties of Diethyl Acetal-Isobutylene Adducts

	C, %	H, %	M.W.	n_D^{25}	d_4^{25} g./ml.	M.R. ml.
Obs. for cut with b.p. 85° at 45 mm.	68.2	12.4	165	1.4091	0.851	50.8
Obs. for cut with 176° at 745 mm.	68.7	12.8	179	1.4072	0.830	51.6
Calc. for C ₁₀ H ₂₂ O ₂	68.95	12.65	174			51.66

The values listed for the 176° cut are in excellent agreement with the theoretical for C₁₀H₂₂O₂. However, the values found for the 85° fraction are not so acceptable. Paul and Tchelitcheff (129) isolated only one isomer of C₁₀H₂₂O₂, which had the following properties: b.p. 70-71° at 20 mm., n_D^{24} 1.4108, d_4^{24} 0.841. These properties are more nearly comparable to those listed for our 85° (45 mm.) product. Still, considering purification difficulties encountered in our work, we must believe that their values probably represent higher purity of the compound. It is interesting to note that the small amount of material boiling at 77° had a refractive index almost identical with that reported by the French authors (1.4105 at 24°). This identity was made even more significant when mass spectrometric patterns were run on both the 77° and 85° fractions. These were similar, but the 77° one actually showed greater intensity values at its crucial peaks. Unfortunately this observation could be carried no further since preparative work had been brought to completion before the need for more rigorous purification was evident. It is not clear why so large a fraction should boil at 85° at 45 mm. and at the same time represent an inadequately purified product. Notwithstanding these facts, the mass patterns obtained show clearly that isomeric products of the reaction of diethyl acetal and isobutylene have been isolated. Table VIII summarizes this proof for the 176° product (A) and the 85° (45 mm.) product (B).

Table VIII

Mass Spectrometer Data on Diethyl Acetal-Isobutylene Adducts

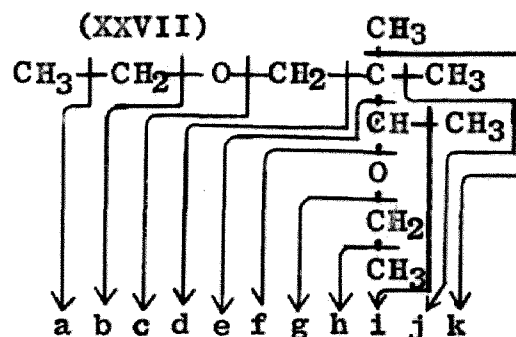
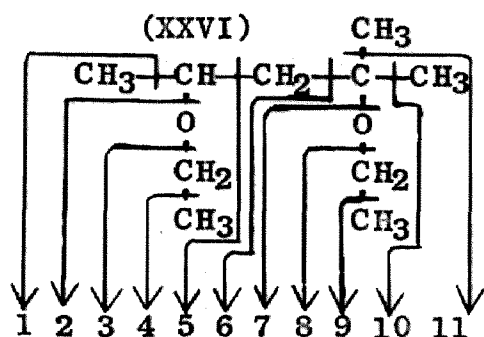

m/e	Relative Intensity <u>A</u>	Relative Intensity <u>B</u>	Fragment	Cleavage by which formed
27	29.06	53.97	C ₂ H ₃	(3,8,b, or g) minus 2H or (1+2+6)
29	46.99	76.93	C ₂ H ₅	3,8,b, or g
43	51.46	135.53	C ₂ H ₃ O	(2 or 7) minus 2H; (c or f) minus 2H; (a + d) minus H; (3 + 5) minus H; (e + g) minus H; (1+3+6) (1+4+5)
45	75.79	156.78	C ₂ H ₅ O	2,7,c, or f
59*	91.58	174.36	EtOCH ₂	d
73	80.88	149.82	EtOCHCH ₃	5 or e
87**	100.00	100.00	Me ₂ COEt	6
113	14.82	20.00	128 fragment minus CH ₃	16 ways total from parent molecule
128	4.66	6.00	Me ₂ CCHCH(OEt)CH ₃	(2,7,c, or f) minus H
145	0.42	0.56	OCHMeCMe ₂ CH ₂ OEt	3,8,b, or g
159	1.88	1.92	Parent molecule minus CH ₃	1,4,9,10,11,a,h,i,j, or k
174	0.04	0.05	Parent molecule	ionization

* Pattern peak unique to (XXVII)

** Pattern peak unique to (XXVI)

A fraction, b.p. 176° at 745 mm., primarily (XXVI).B fraction, b.p. 85° at 45 mm., largely (XXVII) but some (XXVI).

After consideration of the nature of initial reactants and expected products of Prins-type condensations, the physical constants for the two products isolated, and finally the mass spectrometer patterns in Table VIII, there can be no reasonable doubt that the 176° cut is 2,4-diethoxy-2-methylpentane and the 135° cut is largely 1,3-diethoxy-2,2-dimethylbutane.

Methylal and styrene. Styrene, freshly distilled twice to assure its purity as a monomer, was reacted with methylal (using boron trifluoride catalyst) in the following manner. Twenty-six grams of boron trifluoride was bubbled into 250 ml. of methylal with the usual cooling. The mixture was placed in a three-necked flask equipped with a stirrer and dropping funnel. A 130-g. charge of styrene was added dropwise to the methylal with stirring and cooling. After addition of the styrene, the mixture was stirred for an hour and then allowed to stand overnight. Neutralization was accomplished in the usual way. Since there was serious doubt that any resulting condensation product would be steam-distillable, a small portion was tested for steam-volatility. No appreciable amount of product came over so it was considered adequate to extract the products directly with methylal as extraction solvent. The methylal was stripped out and the products distilled under vacuum in the Todd semimicro column. There were obtained 158 g. (72% calculated as $C_{11}H_{16}O_2$) of product with b.p. 151-4° at 4 mm., nearly all at 151°.

The one product isolated was tested with 2,4-dinitrophenylhydrazine reagent (155) to ascertain whether a formal-type

structure was present. The test was negative. From this fact, it followed that the product was very likely the result of addition of one mole of methylal to one mole of styrene to give 1-phenyl-1,3-dimethoxypropane:

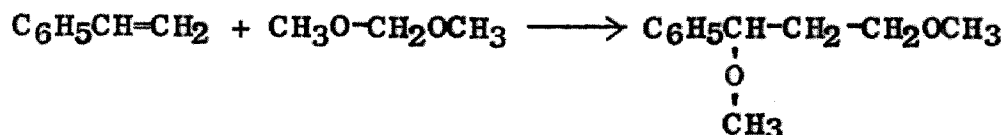

The other possible isomer is not considered likely according to Prins-type orientation.

Chemical and physical data on the compound are herewith presented in verification of the structure postulated.

Table IX

Properties of the Methylal-Styrene Adduct

	C, %	H, %	M.W.	n_D^{25}	d_4^{25} g./ml.	M.R. ml.
Obs. for cut with b.p. 151° at 75 mm.	73.3	9.3	182	1.4866	0.977	53.0
Calc. for 1,3-di methoxy-1-phenyl- propane	73.3	8.9	180			52.7

The above data considered along with previous proofs of structure of products of the condensation of methylal and olefins support the claim that 1,3-dimethoxy-1-phenylpropane has been produced in the above reaction.

Ethylal and styrene. Purified ethylal was prepared in the usual way by the acid-catalyzed reaction between absolute ethanol and paraformaldehyde. A reaction mixture composed of

250 ml. of ethylal, 15 g. of boron trifluoride, and 60 g. of monomeric styrene was made up in the same way that the methylal-styrene batch had been similarly prepared. The neutralization, extraction, and isolation of products via vacuum distillation was also accomplished as for the methylal reaction. The reaction between ethylal and styrene was considerably less complete than for methylal and styrene; about 40 g. of unreacted styrene was recovered and the single product isolated, b.p. 167.8° at 75 mm., was produced in only 35% yield (calculated as C₁₃H₂₀O₂). This yield is not exact, for difficulties encountered during distillation, especially persistent foaming, caused loss of some of the product to fringe cuts in a necessary preliminary distillation.

The Prins-type addition product of this reaction is expected to be a homolog of that of the methylal-styrene condensation, namely 1,3-diethoxy-1-phenylpropane:

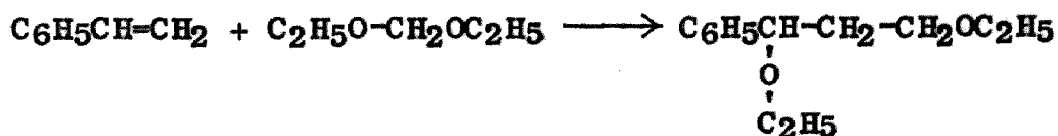

Here too it is considered unlikely that the product isomeric with the above compound was formed, in view of the Prins pattern established thus far for other acetal additions to olefins.

The following chemical and physical properties were found for the product isolated. They are entirely consistent with the structure, 1,3-diethoxy-1-phenylpropane.

Table X
Properties of the Ethylal-Styrene Adduct

	C,%	H,%	M.W.	n_D^{22}	d_4^{22} g./ml.	M.R. ml.
Obs. for cut with b.p. 167.8° at 85 mm.	74.8	9.71	210	1.4772	0.944	62.3
Calc. for 1,3-di- ethoxy-1-phenyl- propane	75.0	9.62	208			61.9

Methylal and cyclohexene. This reaction was accomplished in essentially the same way as the previous methylal-styrene interaction, using the following amounts of reactants: 300 ml. of methylal, 17 g. of boron trifluoride catalyst, and 87 g. of cyclohexene. The reaction temperature was maintained at -5 to -10° for two days and then at room temperature for one day before the mixture was worked up. Preliminary purification using anhydrous ammonia for neutralization caused considerable foaming which made satisfactory distillation quite difficult. It was suspected that the $BF_3:NH_3$ complex formed was the main source of trouble because of its partial solubility in the reaction medium. Hence, this mixture was worked up in the original manner of neutralization with excess aqueous alkali followed by steam distillation of products. A minimum amount of foaming was encountered on distillation of products. Rectification through the Todd semimicro column yielded 54 g. of unreacted olefin and two small plateaus, representing a few per cent each of yield, on a highly complex boiling-point curve. A third

fraction believed to represent a pure compound, was isolated from a previous reaction batch which had been produced with concentrated sulfuric acid catalyst. This same material was not isolated in boron trifluoride-catalyzed runs, however.

Structural identification of the three products isolated was extremely confusing until reference was made to the Prins addition of formaldehyde into cyclohexene done by Olsen and Padberg (116, 117). Their results suggested that product types heretofore not encountered in our work were to be expected. The evidence indicated that we have secured products parallel in type to the ones they obtained. Interpreting this analogy in the light of our own reactants, methylal and cyclohexene, one might expect the following reaction sequence:

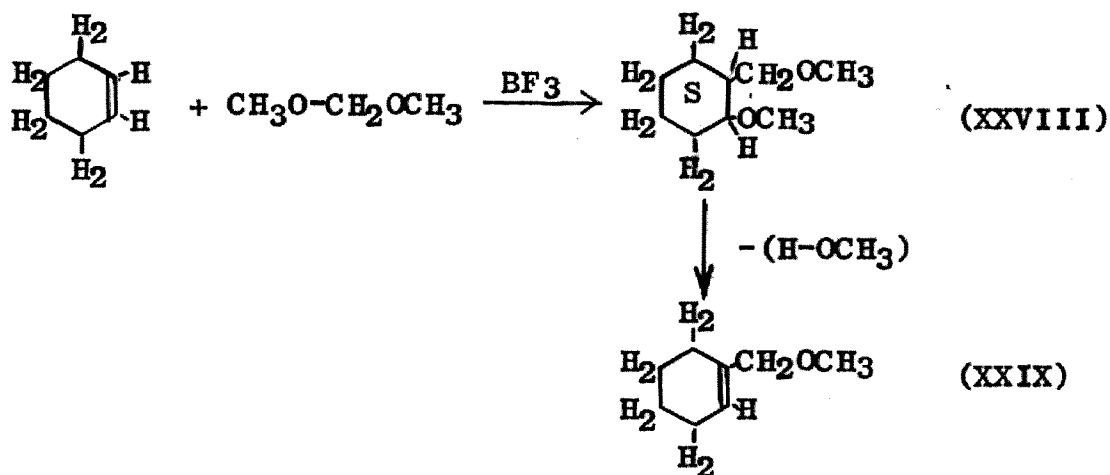

(XXVIII) 1-methoxy-2-methoxymethylcyclohexane

(XXIX) 1-methoxymethylcyclohexene

Definition of a possible reaction course and the product resulting therefrom to fit data gathered for the third component isolated has been difficult. The data on the cut, b.p. 119-120° at

40 mm., are rather contradictory. This cut gave a strong test for the hydroxyl group (155) and the methoxyl group but the bromine number indicates either gross impurity or considerable hindrance to addition of bromine. Thus its identification as 1-methoxy-2-hydroxymethylcyclohexene is uncertain although considerable evidence seems to support some such postulation. Owing to the obviously poor conversion of cyclohexene coupled with the complexity of products formed, it was decided to go no further into the cyclohexene problem than necessary to establish the structures of the compounds isolated in reasonably pure form. There is evidence that the type and yield of products from the sulfuric acid-catalyzed reaction differ somewhat from those produced in the boron trifluoride-catalyzed runs; however, this problem was not studied further.

The three components isolated were characterized as shown in Table XI. The first two fractions are regarded as satisfactorily identified as indicated, but persistently high values on hydrogen found for the last fraction and the low bromine number must mean that pure 1-methoxy-2-hydroxymethylcyclohexene was never obtained. There is obviously considerable evidence, however, that the structure of the material is approximately this.

Table XI
Properties of Methylal-Cyclohexene Adducts

	C,%	H,%	M.W.	n_D^t	d_4^t g./ml.	M.R. ml.
Obs. for cut* with b.p. 158° at 745 mm.	75.8	11.3	125.5	1.4526 (25°)	0.895 (25°)	38.1
Calc. for 1- methoxymethyl- cyclohexene	76.2	11.1	126			38.1
Obs. for cut with b.p. 192-192.5° at 745 mm.	68.0	11.5	158	1.4379 (27°)	0.928 (27°)	44.7
Calc. for 1- methoxy-2- methoxymethyl- cyclohexene	68.3	11.4	158			44.8
Obs. for cut** with b.p. 119-20° at 40 mm.	67.7	10.9	140	1.4622 (24°)	0.986 (24°)	39.6
Calc. for 1- methoxy-2- hydroxymethyl- cyclohexene	67.5	9.9	142			39.6

* Observed bromine number 116, calc. 127.

** Observed bromine number 37, calc. 112.

Methylal and α -pinene. From 500 ml. of methylal, 15 g. of boron trifluoride, and 120 g. of redistilled α -pinene, reacted as in previous condensations, only a little recovered terpene and 27 g. of material boiling at 139-144° at 83 mm. appeared as distinct fractions, even though a column rated at 45-50 theoretical plates was used. Acids are known to isomerize and polymerize pinene extensively, so the lack of plateaus in the

boiling-point curve, indicating a complex mixture, is accountable. A heart cut of the 139-144° fraction boiling at 143.5° at 100 mm. gave a positive methoxyl but negative hydroxyl and carbonyl tests (155). Tests for unsaturation via bromination and reactivity towards neutral permanganate solutions were slow and only weakly positive indicating a saturated structure. Based on the assumption that no isomerization took place, the following structure is postulated as formed in the reaction. No satisfactory reaction mechanism can be presented, however, to support or explain this product.

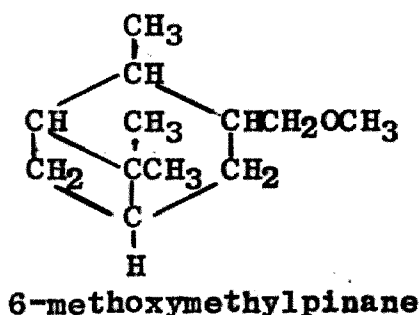

The physical and chemical data obtained in support of this structure are given in Table XII.

Table XII
Properties of Methylal- α -Pinene Adduct

	C, %	H, %	M.W.	n_D^{24}	d_4^{24} g./ml.	M.R. ml.
Observed	79.2	12.1	179	1.4660	0.903	54.9
Calc. for 6-methoxymethylpinane	79.2	12.1	182			54.9

Because of the possibilities of isomerism, the assignment of the structure of 6-methoxymethylpinane must be considered tentative.

Methylal and acetylene. A synthesis of acetals by alcoholation of acetylenes in which mercuric oxide and boron trifluoride were used as co-catalysts (115) suggested the possible addition of methylal to acetylene using the same combination of catalysts. The mercuric salt of the boron fluoride-methanol complex, $\text{Hg}(\text{OCH}_3:\text{BF}_3)_2$, was isolated in the work cited and was thought to be the catalyst in the reaction in which the acetal was formed. The mercuric oxide was made soluble in methanol by the formation of this complex, thereby facilitating the reaction. The methanol-free methylal used in our attempt at an analogous reaction did not facilitate the solution of mercuric oxide by the formation of a similar complex (that is, to any perceptible degree) and as a result no appreciable reaction was accomplished. A trace amount of tarry material was formed in a reaction attempt in which acetylene was bubbled slowly through a methylal-boron fluoride mixture for five hours. It was thought that a reaction might have been effected if a small amount of methanol had been present to aid in solubilizing the mercuric oxide catalyst. However, this variation was tried with no success. The presence of methanol aided in dissolving the mercuric oxide but with the addition of acetylene to the solution a rapid precipitation of an unknown material resulted and apparently ended any chance of possible further reaction. This

type of condensation was abandoned as unfeasible under these reaction conditions.

Solid bed catalyst study. Boron trifluoride has proven to be our most effective catalyst for the condensation reaction presently under study. Sulfuric acid was also effective but had slightly less activity, and was observed to give somewhat different results than boron fluoride. The differing results may be explained by the possibility that the sulfuric acid contained water which could hydrolyze methylal to products that would add into the olefinic double bond. All other acid-type catalysts were found to be ineffective at the temperatures used. The possibility that a solid-bed catalyst would be effective continuously at elevated temperatures was studied in view of the large amount of catalyst needed for each batch reaction run made. Ordinary alumina and acid-impregnated alumina catalysts were tried at various temperatures. A vapor-phase continuous reactor was designed and constructed to use in testing the various solid catalysts chosen for study. Dehydrated alumina was tried initially at temperatures of 100-400° with no success at causing reaction between a mixture of isobutylene and methylal. In separate trials alumina was impregnated with syrupy phosphoric acid, mixed with anhydrous phosphorus pentoxide, mixed with anhydrous aluminum chloride, and finally mixed with a combination of phosphorus pentoxide and boron trifluoride. At temperatures up to 350°, all the above catalyst combinations had no effect on the isobutylene-methylal mixture except to cause breakdown of the methylal at higher temperatures forming large quantities of

formaldehyde. The boron trifluoride-impregnated catalyst had the immediate effect of polymerizing isobutylene and plugging up the catalyst bed.

The above limited study indicates that this method of catalyzing the condensation of acetals to olefins is unfeasible especially at higher temperatures and normal atmospheric pressure.

GENERAL DISCUSSION

Whereas aqueous methylal is known to serve merely as a source of formaldehyde in the Prins reaction (5), anhydrous methylal has been found by this author to add to olefins in the presence of acid catalysts. The reaction parallels the addition of higher acetals to α,β -unsaturated ethers (75) and olefins (129). It was demonstrated by Hoaglin and Hirsh that cleavage of the acetal into an alkoxyalkyl and an alkoxy fragment is involved, and that the alkoxy group becomes attached to the α -carbon atom of the unsaturated ether. Since this has the lower electron density of the olefinic carbon atoms, such orientation is in accordance with that in Prins reactions of aldehydes (118). So far as could be observed, the unsymmetrical olefins that were studied in our laboratory obeyed the same rule, the product resulting from Prins orientation being formed in larger yield in all cases in which proof of structure was effected. Such proof was obtained chemically for the principal propylene-methylal adduct and for the 1,3-butadiene-methylal adduct with 1,4-orientation, and mass-spectrometrically for isobutylene adducts with methylal and diethyl acetal. In the case of isobutylene, while the Prins orientation predominated, isomeric orientation was experienced and proven beyond any reasonable doubt. This was as

expected, however, since a comparatively small difference in relative electronegativity actually exists between a methyl group and a hydrogen atom in influencing polarization of an olefinic double bond. Thus, in the case of the condensation of diethyl acetal with isobutylene, the following alternate orientations of the isobutylene molecule were proved:

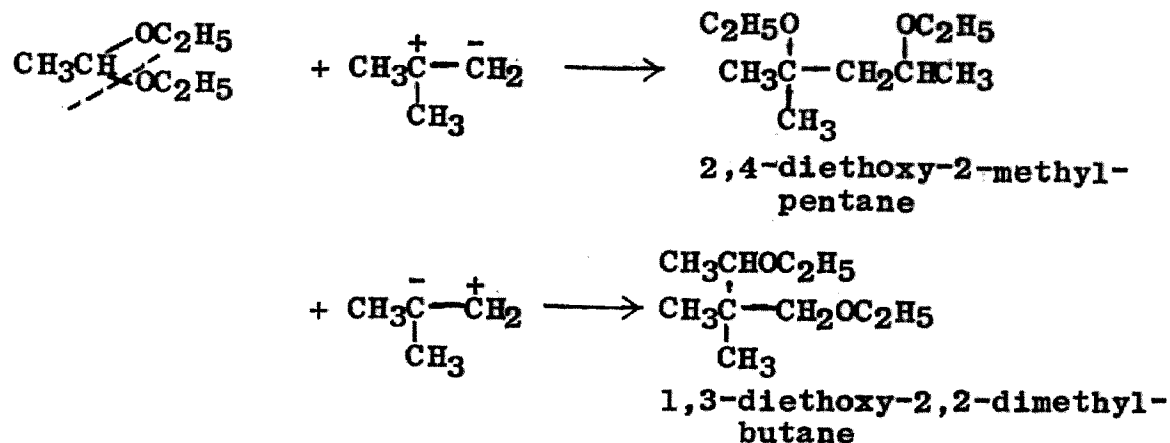

With the above reaction experimentally established, however, we are contradicting the report of Paul and Tchelitcheff (129). They report the isolation of 2,4-dieethoxy-2-methyl-pentane but the properties were more like those of our low-boiling isomer which has been identified as 1,3-dieethoxy-2,2-dimethylbutane. Therefore, it is believed that the French authors were in error and in reality isolated the compound, 1,3-dieethoxy-2,2-dimethylbutane, rather than its isomer as they believed.

Although the major portion of this investigation was confined to the study of various reagents and their reaction products and consequently offered little time for study of optimum reaction conditions, still a limited survey of environmental

conditions most favorable to the condensation indicated that its application on an industrial scale is at present impractical. Excessively large amounts of the more effective catalysts were needed, while most Lewis-type acids as well as several heterogeneous catalysts were found ineffective at temperatures ranging as high as 400°. Reaction studies at higher pressures may eventually facilitate reducing the amount of catalyst now needed; however, such work was not within the scope of the present thesis and consequently was not done.

SUMMARY

In the presence of boron trifluoride, anhydrous methylal adds, as methoxy and methoxymethyl groups, to all olefins tried: propylene, isobutylene, styrene, cyclohexene, α -pinene, and 1,3-butadiene. Orientation corresponds to that in the analogous Prins reaction of aldehydes and olefins. Additional examples of the reaction, although they proceed less readily, are provided by ethylal and styrene and by diethyl acetal and isobutylene. The condensation of acetals with isobutylene at room temperature was found to yield both possible isomers. Propylene was suspected of behaving similarly but no adequate proof of this contention was obtained.

Although boron trifluoride proved to be the best catalyst, sulfuric acid also served adequately in most cases. Other Lewis acids were found ineffective, and acidic heterogeneous catalysts produced none of the desired reaction up to 400°. The amount of boron trifluoride needed in the reaction makes application on an industrial scale prohibitory at the present stage of investigation.

BIBLIOGRAPHY

- (1) Allard, Bull, soc. chim. France 1947, 731, via C.A. 42, 890.
- (2) Allard, Compt. rend. 234, 1020 (1947), via C.A. 43, 5017.
- (3) Amundsen and Brill, J. Am. Chem. Soc. 73, 1834 (1951).
- (4) Arnold (to du Pont), U.S. 2,555,912 (1951), via C.A. 46, 3074.
- (5) Arnold and Dowdall, J. Am. Chem. Soc. 70, 2590 (1948).
- (5a) Arundale and Haworth (to Standard Oil Development Co.), U.S. 2,567,174 (1951), via C.A. 46, 4210.
- (6) Arundale and Mikeska (to Standard Oil Development Co.), U.S. 2,421,862 (1947), via C.A. 41, 5894.
- (7) Arundale and Mikeska (to Jasco, Inc.), U.S. 2,350,485 (1944).
- (8) Arundale and Mikeska (to Standard Oil Development Co.), U.S. 2,296,375 (1942), via C.A. 37, 1129.
- (9) Arundale and Mikeska (to Standard Oil Development Co.), U.S. 2,307,872 (1943).
- (10) Arundale and Mikeska (to Standard Oil Development Co.), U.S. 2,331,158 (1943), via C.A. 38, 1343 (1944).
- (11) Arundale and Mikeska (to Standard Oil Development Co.), U.S. 2,246,285 (1941), via C.A. 35, 6017.
- (12) Arundale and Mikeska (to Standard Oil Development Co.), U.S. 2,253,342 (1941), via C.A. 35, 7974.
- (13) Arundale and Mikeska (to Standard Oil Development Co.), U.S. 2,384,268 (1945), via C.A. 40, 613.
- (14) Arundale and Mikeska (to Standard Oil Development Co.), U.S. 2,312,743 (1943), via C.A. 37, 4749.
- (15) Badische Anilin- and Soda-Fabrik, Ger. 800,298 (1950), via C.A. 45, 1628.

- (16) Bain (to Nelio Resin Process Co.), U.S. 2,340,294 (1944), via C.A. 38, 3990.
- (17) Bain and Best (to Glidden), U.S. 2,453,110 (1948), via C.A. 43, 1807.
- (18) Baker, J. Chem. Soc. 1948, 89.
- (19) Baker, Nature 1948, 171.
- (20) Baker, J. Chem. Soc. 1949, 770.
- (21) Baker, ibid. 1944, 296.
- (22) Brooks (to du Pont), U.S. 2,436,286 (1948), via C.A. 42, 3431.
- (23) Brooks (to du Pont), U.S. 2,449,447 (1948), via C.A. 43, 1055.
- (24) Caldwell and Hagemeyer (to Eastman), U.S. 2,462,357 (1949), via C.A. 43, 3840.
- (25) Caldwell (to Eastman), U.S. 2,450,116-8 (1948), via C.A. 43, 1055.
- (26) Cass (to du Pont), U.S. 2,462,830 (1949), via C.A. 43, 3968.
- (27) Coffman and Jeuner (to du Pont), U.S. 2,555,918 (1951), via C.A. 46, 3566.
- (28) Coffman, Raasch, Rigby, Barrick and Hanford, J. Org. Chem. 14, 747 (1949).
- (29) Colson, Analyst 58, 594 (1933).
- (30) Copenhaver (to General Aniline and Film), U.S. 2,543,312 (1951), via C.A. 45, 5447.
- (31) Copenhaver (to General Aniline and Film), U.S. 2,561,307 (1951), via C.A. 46, 1051.
- (32) Crawford and McLeish (to Imperial Chemical Ind.), U.S. 2,233,835 (1941), via C.A. 35, 3651.
- (33) Croxall and Neher (to Rohm and Haas), U.S. 2,447,975 (1948), via C.A. 42, 8817.
- (34) Daily, J. P. Private communication.
- (35) Dermer, Kohn, and Nelson, J. Am. Chem. Soc. 73, 5869 (1951).

- (36) Dinelli and Marini, Gazz. chim. ital. 67, 312 (1937),
via C.A. 32, 154.
- (37) Dinelli and Marini, ibid. 417, via C.A. 32, 1262.
- (38) Dionneau, ann. chim. (9) 3, 259 (1915).
- (39) The Distillers Co., Ltd., Staudinger and Tuerck, Brit.
539,163 (1941), via C.A. 36, 3509.
- (40) Dreyfus, Fr: 745,973, via C.A. 27, 4243 (1933); U.S.
2,095,320, via C.A. 31, 8545 (1937).
- (41) E. I. du Pont de Nemours, Fr. Pat. 814,839; U.S. 2,135,460
and 2,160,575; Dutch 46,391; Brit. 502,680.
- (42) E. I. du Pont de Nemours, Brit. 483,828 (1938), via C.A.
32, 7167.
- (43) E. I. du Pont de Nemours, Brit. 583,874 (1946), via C.A.
41, 5142.
- (44) Dykstra, J. Am. Chem. Soc. 58, 1747 (1931) and U.S.
2,119,531 (to du Pont) (1938).
- (45) Elek, Ind. Eng. Chem., Anal. Ed. 11, 174 (1939).
- (46) Emerson, J. Org. Chem. 10, 464 (1945).
- (47) Emerson, Deebel, and Longley, ibid. 14, 696 (1949).
- (48) Engel (to Allied Chemical and Dye Co.), U.S. 2,417,548
(1947), via C.A. 41, 3493.
- (49) Fitzky (to General Aniline), U.S. 2,325,760 (1943).
- (50) Fitsky (to I. G. Farbenindustrie), U.S. 2,143,370 (1939).
- (51) Fitzky (to I. G. Farbenindustrie), U.S. 2,124,851 (1939),
via C.A. 32, 7055.
- (52) Fitzky, Publication Board Report 58,826, Office of Technical
Services, U.S. Dept. of Commerce (1946).
- (53) Fourneau, Benoit and Firmenich, Bull. soc. chim. (4) 47,
894 (1930), via C.A. 24, 5740.
- (54) Francis, Ind. Eng. Chem. 18, 821 (1926).
- (55) Gilman, "Organic Chemistry", Vol. II, 1751, New York, Wiley
(1943).

- (56) Glasstone, "Textbook of Physical Chemistry", 646, 2nd ed., New York: D. Van Nostrand Co., 1946.
- (57) Gresham (to du Pont), U.S. 2,405,948 (1946), via C.A. 41, 151.
- (58) Gresham, Jansen, Shaver and Brooks (to Goodrich), U.S. 2,449,987-96 incl., via C.A. 43, 1053-56.
- (59) Gresham and Steadman, J. Am. Chem. Soc. 71, 737 (1949).
- (60) Gresham and Grigsby (to du Pont), U.S. 2,493,964 (1950), via C.A. 44, 4508.
- (61) Gresham (to du Pont), U.S. 2,449,471 (1948), via C.A. 43, 1055.
- (62) Grigsby (to du Pont), U.S. 2,426,015 (1947), via C.A. 42, 588.
- (63) Hagemeyer (to Eastman), U.S. 2,450,131-4 (1948), via C.A. 43, 1056.
- (64) Hagemeyer, Ind. Eng. Chem. 41, 765 (1949).
- (65) Hagemeyer (to Eastman), U.S. 2,469,110 (1949), via C.A. 43, 5414.
- (66) Hagemeyer and Cooper (to Eastman), U.S. 2,469,690 (1949), via C.A. 43, 5794.
- (67) Hamblet and McAlevy (to du Pont), U.S. 2,426,017 (1947), via C.A. 42, 206.
- (68) Hamblet and McAlevy (to du Pont), Brit. 590,571 (1947), via C.A. 42, 589.
- (69) Hanford (to du Pont), U.S. 2,433,844 (1948), via C.A. 42, 2266.
- (70) Harvey (to Harvel Research Corp.), U.S. 2,350,230 (1944), via C.A. 39, 1572.
- (71) Hawkins, Unpublished observations.
- (72) Hawkins, Master's Thesis, Okla. A. and M. College (1949).
- (73) Hawkins and Arthur, Anal. Chem. 23, 533 (1951).
- (74) Hoaglin and Clark (to Union Carbide and Carbon), U.S. 2,564,760 and 2,564,761 (1951), via C.A. 46, 3074.
- (75) Hoaglin and Hirsh, J. Am. Chem. Soc. 71, 3468 (1949).

- (76) I. G. Farbenindustrie, Ger. 672,370 (1939), via C.A. 33, 3928.
- (77) I. G. Farbenindustrie, Brit. 511,966 (1939), via C.A. 35, 140.
- (78) I. G. Farbenindustrie, Brit. 507,571 (1939), via C.A. 34, 449.
- (79) I. G. Farbenindustrie, Fr. 847,255 (1939), via C.A. 35, 5129.
- (80) I. G. Farbenindustrie, Ger. 673,681 (1939), via C.A. 33, 6339.
- (81) I. G. Farbenindustrie, Brit. 465,467 (1937), via C.A. 31, 7067.
- (82) I. G. Farbenindustrie, Fr. 812,292 (1937), via C.A. 32, 952.
- (83) Imperial Chemical Industries, Ltd., Brit. 615,634 (1949), via C.A. 43, 4685; also Walker (to du Pont), U.S. 2,463,227 (1949), via C.A. 43, 5035.
- (84) Imperial Chemical Industries, Ltd., Brit. 528,761 (1940), via C.A. 35, 7975.
- (85) Imperial Chemical Industries, Ltd., Fr. 845,230 (1939), via C.A. 35, 1070.
- (86) Kharasch, Urry and Jensen, J. Am. Chem. Soc. 67, 1626 (1945), via C.A. 40, 59.
- (87) Kohn, Master's Thesis, Okla. A. and M. College (1948).
- (88) Kriewitz, Ber. 32, 57 (1899).
- (89) Kung (to Goodrich Co.), U.S. 2,356,459 (1944), via C.A. 39, 88.
- (90) Langlois, ann. chim. (9) 12, 265 (1919).
- (91) Lewis and Bradstreet, Ind. Eng. Chem., Anal. Ed. 12, 387 (1940).
- (92) LoCicero and Johnson, J. Am. Chem. Soc. 74, 2094 (1952).
- (93) Loder (to du Pont), U.S. 2,289,548 (1942).
- (94) Loder, U.S. 2,135,460 (1938).

- (95) Londergen (to du Pont), U.S. 2,461,906 (1949), via C.A. 43, 3835.
- (96) Marsh (to Standard Oil Development Co.), U.S. 2,389,205 (1945), via C.A. 40, 1533.
- (97) Martin (to du Pont), U.S. 2,143,021 (1939), via C.A. 33, 2907.
- (98) Matti, Bull. soc. chim. (4), 51, 974 (1932).
- (99) McBee, Marzluff, and Pierce; J. Am. Chem. Soc. 74, 444 (1952)
- (100) McLeish and Crawford (to Imperial Chemical Ind.), Brit. 514,619 (1939), via Walker, "Formaldehyde", p. 231, New York, Reinhold (1944).
- (101) Mead (to Imperial Chemical Ind.), Brit. 550,854 (1943), via C.A. 38, 1751.
- (102) Mikeska (to Standard Oil Development Co.), U.S. 2,307,894 (1943), via C.A. 37, 3542; also 2,367,324 via C.A. 39, 2765; 2,350,517 (C.A. 38, 4965); 2,337,059 via C.A. 38, 3291.
- (103) Mikeska, Arundale and Mottern (to Standard Oil Development Co.), Can. 434,624 (1946), via C.A. 40, 5445.
- (104) Mikeska and Arundale (to Standard Oil Development Co.), U.S. 2,356,683 (1944), via C.A. 39, 91.
- (105) Mikeska and Arundale (to Standard Oil Development Co.), U.S. 2,308,192 (1943).
- (106) Mikeska and Arundale (to Standard Oil Development Co.), U.S. 2,449,001 (1948), via C.A. 43, 673.
- (107) Mottern (to Jasco, Inc.), U.S. 2,335,691 (1943).
- (108) Mottern (to Standard Oil Development Co.), U.S. 2,386,055 (1945), via C.A. 39, 5467.
- (109) Mueller-Cunradi and Pieroh, U.S. Pat. 2,165,962 (1939).
- (110) Munday and Matuszak (to Standard Oil Development Co.), U.S. 2,490,276 (1949), via C.A. 44, 6425.
- (111) Nelson, Master's Thesis, Okla. A. and M. College (1950).
- (112) Nenitzescu and Przemetski, Ber. 69B, 2706 (1936).
- (113) Nenitzescu and Przemetski, ibid. 74B, 676 (1941)

- (114) Niederl and Niederl. "Organic Quantitative Microanalysis", p. 221-9. 2nd ed., New York: Wiley, 1942.
- (115) O'Leary and Wenzke, J. Am. Chem. Soc. 55, 2117 (1933).
- (116) Olsen and Padberg, Z. Naturforsch. 1, 671 (1946).
- (117) Olsen and Padberg, ibid. 1, 257,448 (1946).
- (118) Olsen, ibid. 1, 676 (1946).
- (119) Olsen, Acta Chem. Scand. 4, 462,473,901 (1950).
- (120) Olsen, ibid. 5, 1168 (1951).
- (121) Olsen, ibid. 1326 (1951).
- (122) Olsen, ibid. 1339 (1951).
- (123) Olsen and Aksnes, ibid. 4, 993 (1950).
- (124) Olsen, Fr. 933,182 (1948), via C.A. 44, 1130 and Ind. Eng. Chem. 42, 1671.
- (125) Olsen, Kuhn and Friedberg, Chem. Ber. 81, 540 (1948).
- (126) Olsen, Norw. 74, 890 (1949), via C.A. 44, 4495.
- (127) Paul and Tchelitcheff, Compt. rend. 224, 1722 (1947).
- (128) Paul and Tchelitcheff, Bull. soc. chim. France 1950, 1155.
- (129) Paul and Tchelitcheff, ibid. 1951, 125.
- (130) Pavlic and Adkins, J. Am. Chem. Soc. 68, 1471 (1946).
- (131) Pigulevskii and Tatarskaya, Zhur. Obshchei Khim. 20, 1456 (1950), via C.A. 45, 2480.
- (132) Price, "Reaction at Carbon-Carbon Double Bonds", p. 45, New York, Interscience (1946).
- (133) Price, Benton and Schmidle, J. Am. Chem. Soc. 71, 2860 (1949).
- (134) Price and Dickman, Ind. Eng. Chem. 40, 257 (1948).
- (135) Price and Krishnamurti, J. Am. Chem. Soc. 72, 5334 (1950).
- (136) Price and Krishnamurti, ibid. 72, 5335 (1950)
- (137) Prins, Chem. Weekblad 14, 627 (1917), via Chem. Ztrb. II, 289 (1917).

- (138) Prins, *ibid.* 14, 932 (1917), via Chem. Ztrb. I, 168 (1918).
- (139) Prins, *ibid.* 16, 1072 (1919), via C.A. 13, 3155.
- (140) Prins, Proc. Acad. Sci. Amsterdam 27, 1496 (1919), via C.A. 14, 1662.
- (141) Prins, Chem. Weekblad 16, 1510 (1919), via C.A. 14, 1119.
- (142) Prins, Rec. trav. chim. 51, 469 (1932).
- (143) Pudovik and Arbuzov, Izvest. Akad. Nauk S.S.S.R., Otdel. Khim. Nauk 1946, 427, via C.A. 42, 6311.
- (144) Pudovik, Nitikins, and Aigistova, Zhur. Obshchei Khim. (J. Gen. Chem.) 19, 279 (1949), via C.A. 43, 6568.
- (145) Pudovik and Arbuzov, Bull. acad. sci. U.R.S.S., Classe sci. chim. 1948, 246, via C.A. 42, 4973.
- (146) Pudovik, Izvest. Akad. Nauk S.S.S.R., Otdel. Khim. Nauk 1949, No. 1, 839, via C.A. 43, 5737.
- (147) Ritter (to Standard Oil Development Co.), U.S. 2,362,307 (1944).
- (148) Ritter (to Standard Oil Development Co.), U.S. 2,335,027 (1943).
- (149) Roberts (to Imperial Chemical Ind.), U.S. 2,379,104 (1945), via C.A. 39, 4621.
- (150) Roberts (to Imperial Chemical Ind.) Brit. 550,853 (1943), via C.A. 38, 1751.
- (151) Rosen and Arundale (to Standard Oil Development Co.), U.S. 2,368,494 (1945), via C.A. 39, 4529.
- (152) Rosen and Arundale (to Standard Oil Development Co.), U.S. 2,504,732 (1950), via C.A. 44, 6891.
- (153) Rupe and Miller, Helv. Chim. Acta 4, 841 (1921), via C.A. 16, 1085.
- (154) Scott (to du Pont), U.S. 2,024,749 (1935), via Walker, "Formaldehyde", p. 230, New York, Reinhold (1944).
- (155) Shriner and Fuson, "The Systematic Identification of Organic Compounds", 3rd ed., New York: Wiley, 1948.
- (156) Short (to Imperial Chemical Ind.), U.S. 2,408,889 (1946), via C.A. 41, 773.

- (157) Short (to Imperial Chemical Ind.), Brit. 579,855 (1946),
via C.A. 41, 2431.
- (158) Shortridge, J. Am. Chem. Soc. 70, 873 (1948).
- (159) Société des Usines Chimique Rhône-Poulenc, Fr. 717,712
(1930), via Walker, "Formaldehyde", p. 229, New York,
Reinhold (1944).
- (160) Smith, Norton, and Ballard, J. Am. Chem. Soc. 73, 5267
(1951) and earlier references there cited.
- (161) Standard Oil Development Co., Brit. 544,737 (1942),
via C.A. 36, 7030.
- (162) Standard Oil Development Co., Brit. 559,041 (1944), via
C.A. 39, 4632.
- (163) Standard Oil Development Co., Brit. 578,438 (1946), via
C.A. 41, 3492.
- (164) Standard Oil Development Co., Brit. 545,191 (1942), via
C.A. 36, 7030.
- (165) Steadman (to Goodrich Co.), U.S. 2,424,589 (1947), via
C.A. 41, 7413.
- (166) Steadman and Breyfogle (to Goodrich Co.), U.S. 2,424,590
(1947), via C.A. 41, 7413.
- (167) Steyermark, Anal. Chem. 20, 368 (1948).
- (168) Stone (to Eastman), U.S. 2,469,704 (1949), via C.A. 43,
5795.
- (169) Straus and Thiel, Ann. 525, (1936), via C.A. 31, 363.
- (170) Straus, Ger. 647,192 (1937), via C.A. 31, 7066.
- (171) Straus, Ger. 671,063 (1939), via C.A. 33, 3390.
- (172) Vogel, "A Textbook of Practical Organic Chemistry", p. 325,
Longmans, Green and Co., London, New York (1948).
- (173) Whitner (to Standard Oil Development Co.), U.S. 2,443,409
(1948), via C.A. 42, 7043.
- (174) Williams and Ballard (to Shell Development), U.S. 2,452,977
(1946), via C.A. 43, 3042.
- (175) Workman (to Cities Service Oil Co.), U.S. 2,412,762 (1946),
via C.A. 41, 1694.

VITA

John Joseph Hawkins
candidate for the degree of
Doctor of Philosophy

Thesis: THE CONDENSATION OF METHYLAL AND OTHER ACETALS WITH
OLEFINS

Major: Organic Chemistry
Minor: Analytical Chemistry

Biographical and Other Items:

Born: August 8, 1922 at Los Angeles, California
Undergraduate Study: Marquette University-Milwaukee, Wis.,
1941-1943 also 1945-1947; B.S. degree, 1947
Graduate Study: O.A.M.C. 1947-51; M.S. degree, 1949
Experience: Fighter pilot, Army Air Forces in Italy, North
Africa attached with 94th Squadron of 1st Fighter Group
in 15th Air Force 1944-45. Awards-D.F.C., Air Medal
with five oak leaf clusters, Presidential Unit Citation.
Research assistant in Chemistry Department 1947 and 1948
Research Fellow in Chemistry Department 1949 and 1950
Teaching Fellow in Chemistry Department 1951

Member of American Chemical Society, Phi Lambda Upsilon, and
full member of The Society of the Sigma Xi 1951

Date of Final Examination: July 12, 1952

THESIS TITLE: The Condensation of Methylal
and Other Acetals with Olefins

NAME OF AUTHOR: John J. Hawkins

THESIS ADVISER: O. C. Dermer

The content and form have been checked and approved by the author and thesis adviser. Changes or corrections in the thesis are not made by the Graduate School office or by any committee. The copies are sent to the bindery just as they are approved by the author and faculty adviser.

TYPIST: Mary W. Norman